

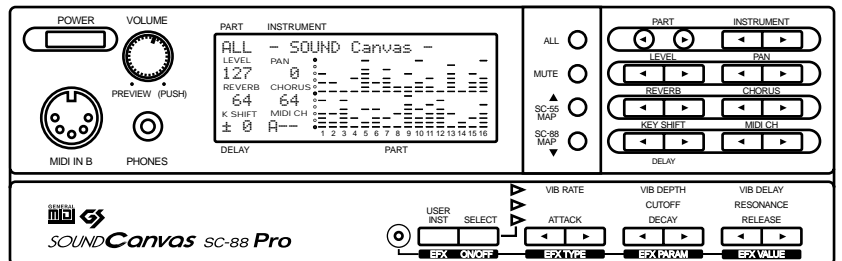

SOUND Canvas

MIDI SOUND GENERATOR *SC-88 Pro*



	CAUTION RISK OF ELECTRIC SHOCK DO NOT OPEN	
ATTENTION: RISQUE DE CHOC ELECTRIQUE NE PAS OUVRIIR		
<p>CAUTION: TO REDUCE THE RISK OF ELECTRIC SHOCK, DO NOT REMOVE COVER (OR BACK). NO USER-SERVICEABLE PARTS INSIDE. REFER SERVICING TO QUALIFIED SERVICE PERSONNEL.</p>		



The lightning flash with arrowhead symbol, within an equilateral triangle, is intended to alert the user to the presence of uninsulated "dangerous voltage" within the product's enclosure that may be of sufficient magnitude to constitute a risk of electric shock to persons.



The exclamation point within an equilateral triangle is intended to alert the user to the presence of important operating and maintenance (servicing) instructions in the literature accompanying the product.

INSTRUCTIONS PERTAINING TO A RISK OF FIRE, ELECTRIC SHOCK, OR INJURY TO PERSONS.

IMPORTANT SAFETY INSTRUCTIONS

SAVE THESE INSTRUCTIONS

WARNING - When using electric products, basic precautions should always be followed, including the following:

1. Read all the instructions before using the product.
2. Do not use this product near water — for example, near a bathtub, washbowl, kitchen sink, in a wet basement, or near a swimming pool, or the like.
3. This product should be used only with a cart or stand that is recommended by the manufacturer.
4. This product, either alone or in combination with an amplifier and headphones or speakers, may be capable of producing sound levels that could cause permanent hearing loss. Do not operate for a long period of time at a high volume level or at a level that is uncomfortable. If you experience any hearing loss or ringing in the ears, you should consult an audiologist.
5. The product should be located so that its location or position does not interfere with its proper ventilation.
6. The product should be located away from heat sources such as radiators, heat registers, or other products that produce heat.
7. The product should be connected to a power supply only of the type described in the operating instructions or as marked on the product.
8. The power-supply cord of the product should be unplugged from the outlet when left unused for a long period of time.
9. Care should be taken so that objects do not fall and liquids are not spilled into the enclosure through openings.
10. The product should be serviced by qualified service personnel when:
 - A. The power-supply cord or the plug has been damaged; or
 - B. Objects have fallen, or liquid has been spilled onto the product; or
 - C. The product has been exposed to rain; or
 - D. The product does not appear to operate normally or exhibits a marked change in performance; or
 - E. The product has been dropped, or the enclosure damaged.
11. Do not attempt to service the product beyond that described in the user-maintenance instructions. All other servicing should be referred to qualified service personnel.

For the USA

This product may be equipped with a polarized line plug (one blade wider than the other) . This is a safety feature. If you are unable to insert the plug into the outlet, contact an electrician to replace your obsolete outlet. Do not defeat the safety purpose of the plug.

For Canada

For Polarized Line Plug

CAUTION: TO PREVENT ELECTRIC SHOCK, MATCH WIDE BLADE OF PLUG TO WIDE SLOT, FULLY INSERT.

ATTENTION: POUR ÉVITER LES CHOCS ÉLECTRIQUES, INTRODUIRE LA LAME LA PLUS LARGE DE LA FICHE DANS LA BORNE CORRESPONDANTE DE LA PRISE ET POUSSER JUSQU' AU FOND.

For the U.K.

IMPORTANT: THE WIRES IN THIS MAINS LEAD ARE COLOURED IN ACCORDANCE WITH THE FOLLOWING CODE.

BLUE: NEUTRAL
BROWN: LIVE

As the colours of the wires in the mains lead of this apparatus may not correspond with the coloured markings identifying the terminals in your plug, proceed as follows:
The wire which is coloured BLUE must be connected to the terminal which is marked with the letter N or coloured BLACK.
The wire which is coloured BROWN must be connected to the terminal which is marked with the letter L or coloured RED.
Under no circumstances must either of the above wires be connected to the earth terminal of a three pin plug.



USING THE UNIT SAFELY

INSTRUCTIONS FOR THE PREVENTION OF FIRE, ELECTRIC SHOCK, OR INJURY TO PERSONS

About ⚠ WARNING and ⚠ CAUTION Notices









⚠ WARNING	Used for instructions intended to alert the user to the risk of death or severe injury should the unit be used improperly.
⚠ CAUTION	Used for instructions intended to alert the user to the risk of injury or material damage should the unit be used improperly. * Material damage refers to damage or other adverse effects caused with respect to the home and all its furnishings, as well to domestic animals or pets.

About the Symbols







	The ⚠ symbol alerts the user to important instructions or warnings. The specific meaning of the symbol is determined by the design contained within the triangle. In the case of the symbol at left, it is used for general cautions, warnings, or alerts to danger.
	The ⚡ symbol alerts the user to items that must never be carried out (are forbidden). The specific thing that must not be done is indicated by the design contained within the circle. In the case of the symbol at left, it means that the unit must never be disassembled.
	The ⏻ symbol alerts the user to things that must be carried out. The specific thing that must be done is indicated by the design contained within the circle. In the case of the symbol at left, it means that the power-cord plug must be unplugged from the outlet.

ALWAYS OBSERVE THE FOLLOWING

⚠ WARNING

- Before using this unit, make sure to read the instructions below, and the Owner's Manual. 
- Do not open or perform any internal modifications on the unit. 
- Make sure you always have the unit placed so it is level and sure to remain stable. Never place it on stands that could wobble, or on inclined surfaces. 
- Avoid damaging the power cord. Do not bend it excessively, step on it, place heavy objects on it, etc. A damaged cord can easily become a shock or fire hazard. Never use a power cord after it has been damaged. 
- In households with small children, an adult should provide supervision until the child is capable of following all the rules essential for the safe operation of the unit. 
- Protect the unit from strong impact. (Do not drop it!) 
- Do not force the unit's power-supply cord to share an outlet with an unreasonable number of other devices. Be especially careful when using extension cords—the total power used by all devices you have connected to the extension cord's outlet must never exceed the power rating (watts/amperes) for the extension cord. Excessive loads can cause the insulation on the cord to heat up and eventually melt through. 
- Before using the unit in a foreign country, consult with your dealer, or qualified Roland service personnel. 

⚠ CAUTION

- Always grasp only the plug on the power-supply cord when plugging into, or unplugging from an outlet. 
- Try to prevent cords and cables from becoming entangled. Also, all cords and cables should be placed so they are out of the reach of children. 
- Never climb on top of, nor place heavy objects on the unit. 
- Never handle the power cord or its plug with wet hands when plugging into, or unplugging from, an outlet. 
- Before moving the unit, disconnect the power plug from the outlet, and pull out all cords from external devices. 
- Before cleaning the unit, turn off the power and unplug the power cord from the outlet. 
- Whenever you suspect the possibility of lightning in your area, pull the plug on the power cord out of the outlet. 

Before using this unit, carefully read the sections entitled: "USING THE UNIT SAFELY" and "IMPORTANT NOTES" (p.3). These sections provide important information concerning the proper operation of the unit. Additionally, in order to feel assured that you have gained a good grasp of every feature provided by your new unit, this manual should be read in its entirety. The manual should be saved and kept on hand as a convenient reference.

Introduction

Main features of this unit

- This unit is a sound module compatible with the General MIDI system. It can be used to playback any song data (General MIDI scores) bearing the General MIDI logo. This unit is also compatible with the Roland GS format. It can be used to playback any song data bearing the GS logo.
- This unit is a 32 part 64 voice multi-timbral sound module. A single this unit can produce the sounds of a large ensemble. It is an ideal sound module for use with sequencers or personal computers. (p.120)
- This unit contains 1117 high quality sounds and 42 types of drum sound set (including 3 sound effects sets). These sound include the same sounds as the SC-55/55mkII and SC-88, allowing SC-55/55mkII and SC-88 song data to be played back correctly. (p.10)
- A wide variety of effects are provided: 64 types of insertion effect, eight types each of reverb and chorus effects, 10 types of delay, and 2-band equalizer. In addition, the values of relevant parameters can be set for each effect, allowing professional-level manipulation of sound. (p.46, 56)
- There are 256 user sounds and 2 user drum sets, allowing you to create your own sounds and drum sets. (p.96, 102)
- By editing sound parameters such as vibrato, filter and envelope, you can modify sounds to your taste. (p.31)
- The computer connector allows this unit to be directly connected to an Apple or IBM personal computer. (p.120)
- The large display screen graphically provides easy visual confirmation of settings such as volume for each part, and pictures and character data can also be displayed in the dot matrix (ten screens). (p.110)
- A wide variety of sound parameters can be edited directly and easily by pressing dedicated buttons. (p.11, 31)
- Audio input jacks with input level adjustment allow you to connect another sound source, and output it from the audio output jacks mixed with this unit's own sound. Two sets of audio output jacks are also provided. (p.15)



General MIDI system

The General MIDI system is a set of recommendations which seeks to provide a way to go beyond the limitations of proprietary designs, and standardize the MIDI capabilities of sound generating devices. Sound generating devices and music data that meets the General MIDI standard bears the General MIDI logo (). Music data bearing the General MIDI logo can be played back using any General MIDI sound generating unit to produce essentially the same musical performance.



GS format

The () Format is Roland's set of specifications for standardizing the performance of sound generating devices. In addition to including support for everything defined by the General MIDI System, the highly-compatible GS Format additionally offers an expanded number of sounds, provides for the editing of sounds, and spells out many details for a wide range of extra features, including effects such as reverb and chorus.

Designed with the future in mind, the GS Format can readily include new sounds and support new hardware features when they arrive. Since it is upwardly compatible with the General MIDI System, Roland's GS Format is capable of reliably playing back GM Scores equally as well as it performs GS Music Data (music data that has been created with the GS Format in mind).

Apple is a registered trademark of Apple Computer, Inc.

Macintosh is a registered trademark of Apple Computer, Inc.

MacOS is a trademark of Apple Computer, Inc.

IBM is a registered trademark of International Business Machines Corporation.

IBM PC is a registered trademark of International Business Machines Corporation.

GS () is a registered trademark of Roland Corporation.

IMPORTANT NOTES

In addition to the items listed under "IMPORTANT SAFETY INSTRUCTIONS" and "USING THE UNIT SAFELY", please read and observe the following:

Power Supply

- Do not use this unit on the same power circuit with any device that will generate line noise (such as an electric motor or variable lighting system).
- Before connecting this unit to other devices, turn off the power to all units. This will help prevent malfunctions and/or damage to speakers or other devices.

Placement

- Using the unit near power amplifiers (or other equipment containing large power transformers) may induce hum. To alleviate the problem, change the orientation of this unit; or move it farther away from the source of interference.
- This device may interfere with radio and television reception. Do not use this device in the vicinity of such receivers.
- Do not expose the unit to direct sunlight, place it near devices that radiate heat, leave it inside an enclosed vehicle, or otherwise subject it to temperature extremes. Excessive heat can deform or discolor the unit.

Maintenance

- For everyday cleaning wipe the unit with a soft, dry cloth or one that has been slightly dampened with water. To remove stubborn dirt, use a cloth impregnated with a mild, non-abrasive detergent. Afterwards, be sure to wipe the unit thoroughly with a soft, dry cloth.
- Never use benzene, thinners, alcohol or solvents of any kind, to avoid the possibility of discoloration and/or deformation.

Repairs and Data

- Please be aware that all data contained in the unit's memory may be lost when the unit is sent for repairs. Important data should always be backed up in another MIDI device (e.g., a sequencer), or written down on paper (when possible). During repairs, due care is taken to avoid the loss of data. However, in certain cases (such as when circuitry related to memory itself is out of order), we regret that it may not be possible to restore the data, and Roland assumes no liability concerning such loss of data.

Memory Backup

- This unit contains a battery which powers the unit's memory circuits while the main power is off. When this battery becomes weak, the message shown below will appear in the display. Once you see this message, have the battery replaced with a fresh one as soon as possible to avoid the loss of all data in memory. To have the battery replaced, consult with your dealer, or qualified Roland service personnel.
"Battery Low"

Additional Precautions

- Please be aware that the contents of memory can be irretrievably lost as a result of a malfunction, or the improper operation of the unit. To protect yourself against the risk of losing important data, we recommend that you periodically save a backup copy of important data you have stored in the unit's memory in another MIDI device (e.g., a sequencer).
- Unfortunately, it may be impossible to restore the contents of data that was stored in another MIDI device (e.g., a sequencer) once it has been lost. Roland Corporation assumes no liability concerning such loss of data.
- Use a reasonable amount of care when using the unit's buttons, sliders, or other controls; and when using its jacks and connectors. Rough handling can lead to malfunctions.
- Never strike or apply strong pressure to the display.
- When connecting / disconnecting all cables, grasp the connector itself—never pull on the cable. This way you will avoid causing shorts, or damage to the cable's internal elements.
- A small amount of heat will radiate from the unit during normal operation.
- To avoid disturbing your neighbors, try to keep the unit's volume at reasonable levels. You may prefer to use headphones, so you do not need to be concerned about those around you (especially when it is late at night).
- When you need to transport the unit, package it in the box (including padding) that it came in, if possible. Otherwise, you will need to use equivalent packaging materials.

About this owner's manual

Parameter names are often abbreviated in this unit's display. For example, Chorus Rate is abbreviated as 'Cho Rate'. The full name of the parameter will be used in the manual to avoid any confusion.

If a parameter's value is continuously variable, it will be shown as being a number from 0 — 127. If, on the other hand, a parameter value is selectable in discrete steps, those steps will be shown as 200/400Hz (for example).

Panel buttons are indicated within square brackets [r], such as [CHORUS].

Regarding Screen Displays

Where possible, we will use the actual screen displays for explanations. Keep in mind, however, that the displays of your unit may vary slightly depending on your instrument's settings.

CONTENTS

USING THE UNIT SAFELY	1
Introduction	2
IMPORTANT NOTES	3
CONTENTS	4
Front and rear panel	6

Chapter 1. Try out the unit (Quick start)

■ Connect a MIDI keyboard and play the sounds.....	8
● Making connections.....	8
● Turning the power on or off	9
● Is there sound?.....	9
■ Try out the various sounds	10
■ Try out the buttons of the unit.....	11
■ Apply effects to the sound	13
■ Tuning to other instruments (Tuning)	14
■ Headphones	15
■ Audio input jacks / Audio input volume.....	15

Chapter 2. Parts and parameters

■ Parts and sounds	18
● Assigning a sound to a Part	18
● Selecting Variation sounds.....	20
● Reading the Instrument numbers and Variation numbers	21
● Part Channels.....	22
● Which MIDI IN will be used by each Part?	23
● How simultaneous note numbers and Voices are related.	24
● Concerning legato-enabled sounds.....	24
■ Part parameters for performance	25
[1] Parameters that can be set directly using the buttons	25
[2] Parameters that must be selected from the menu.....	26
● What each parameter does	27
■ Part parameters for sound editing	31
● Procedure.....	31
● What each parameter does	32
■ Setting parameters common to all Parts	34
● Procedure.....	34
● How each parameter works.....	35

■ System parameter settings.....	36
● Procedure.....	36
● How each System parameter works.....	37
■ Using Patches	39
● Loading a Patch	40
● Using MIDI messages to select Patches.....	41
■ Creating a Drum Set (Drum Edit).....	42
● Drum editing procedure.....	42
● Using Chorus and Delay	44
● About Assign Group	44

Chapter 3. System Effects

■ How the effect section of the unit is organized	46
■ System Effect settings.....	48
● Equalizer setting procedure.....	48
● Equalizer parameter functions.....	49
● When you want to adjust the system effect for all Parts	50
● When you want to adjust the system effect for each Part.....	50
● Setting Reverb/Chorus/Delay parameters.....	51
● Reverb parameter function.....	52
● Chorus parameter function.....	53
● Delay parameter function	54

Chapter 4. Insertion Effects

■ Insertion effect settings	56
● Making Insertion effect settings.....	56
● Different effect types	57
■ Using controllers to modify effect parameters	92
● Setting procedure	92
● How each parameter works.....	93

Chapter 5. Convenient functions

- Create and save a sound (User Instrument) ..96
- Creating and saving an Instrument effect (User Effect)99
- Creating and saving a Patch(User Patch)100
- Saving a Drum Set you created (User Drum)...102
- Copying or Exchanging settings between Parts / Initializing Part settings106
- Recording all settings on a sequencer107
 - Bulk Dump procedure.....107
 - Transmitting Individual Data108
- Draw pictures or characters in the display (Frame Draw)110
- Creating compatible data for the unit / SC-88.....112
- Selecting the CM-64 sound map114
 - Differences between the CM-64 and the unit115
- Using the unit as two sound modules.....116
 - Selecting Double Module Mode116
- Initialize118
 - Initialize all Parts to the factory settings118
 - Initialize for GM/GS118

Chapter 6. Using the unit with a personal computer

- Connections with your Computer120
 - Connections with computer connector120
 - Connections with MIDI connectors.....122
 - MIDI data transfer with the computer123
 - Connecting another MIDI sound source to the unit125
- Using MIDI messages to select sounds.....126
 - Using MIDI messages to select Drum Sets.....128

Chapter 7. MIDI and the unit

- About MIDI130
 - How MIDI messages are transmitted and received.....130
 - MIDI channels and multi-timbral sound modules.....130
- MIDI messages that can be received by the unit.....131
- Device ID number settings134
- MIDI message routing settings and switches135
 - [1] Switches which apply to all Parts (A)135
 - [2] Switches which apply to all Parts (B)139
 - [3] Switches which can be set individually for each Part.....141

Chapter 8. Appendix

- Troubleshooting.....146
- If a message appears.....148
- Computer cable wiring diagrams.....149
- Parameter list and operations150
- Instrument list154
- Drum set list163
- Effect list.....176
- Effect data table183
- Preset Patch list186
- MIDI implementation188
- MIDI Implementation Chart209
- INDEX210
- Information212

Front and rear panel

Front panel

- MIDI IN B connector (front) (p.135)

When IN B Select is set to Rear (the factory setting), the front MIDI IN B connector cannot be used.

- Power switch (p.9)
- Volume knob (p.9)
- Preview switch (p.11)
- Headphone jack (p.15)
- Display screen (p.37)
- Bar display (p.23, 37)

- All button (p.34)
 - Mute button (p.25, 34)
 - SC-55 Map button (p.25, 34)
 - SC-88 Map button (p.25, 34)
 - Part buttons (p.18)
 - Level buttons (p.25, 34)
 - Reverb buttons (p.50)
 - Key Shift buttons (p.25, 34)
 - Delay buttons (p.50)
 - Instrument buttons (p.18)
 - Pan buttons (p.25, 34)
 - Chorus buttons (p.50)
 - MIDI Channel buttons (p.22)
- * While holding down the [I] button, you can press the [r] button to make the value change faster.

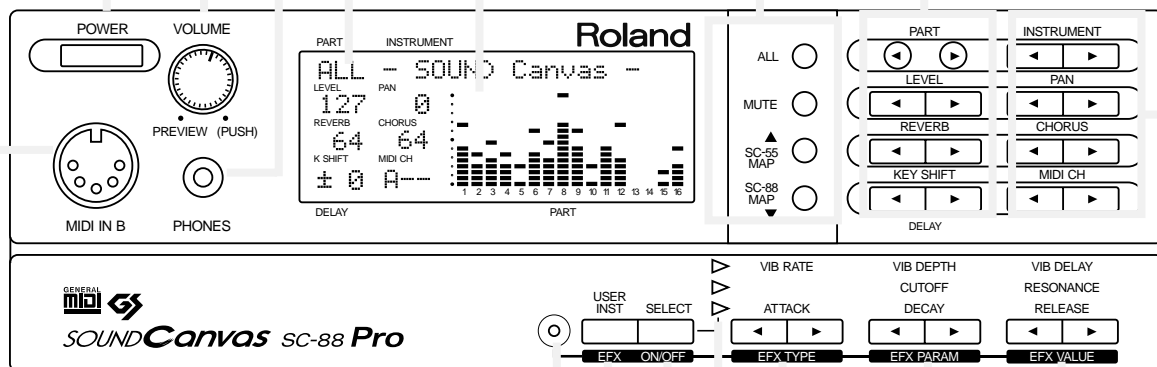

- Effect (orange) (p.56)/User Edit (red) indicator (p.97)
- User Inst button (p.97)/Effect button (p.56)
- Select button (p.56)/Effect ON/OFF button (p.56)
- Select (p.31)/Effect ON/OFF indicator (p.56)

- Effect type buttons (p.56)
- Vibrato Rate buttons (p.31)
- Envelope Attack buttons (p.31)
- Effect parameter buttons (p.56)
- Vibrato Depth buttons (p.31)
- Filter Cutoff Frequency buttons (p.31)
- Envelope Decay buttons (p.31)

Rear panel

- MIDI OUT/THRU connector

This connector functions either as MIDI OUT or MIDI THRU, depending on the setting of OUT/THRU Select (p.136). When the unit is shipped, this is set to MIDI OUT.

- MIDI IN A connector (p.130)
- MIDI IN B connector (rear) (p.135)

- Effect value buttons (p.56)
- Vibrato Delay buttons (p.31)
- Filter Resonance buttons (p.31)
- Envelope Release buttons (p.31)

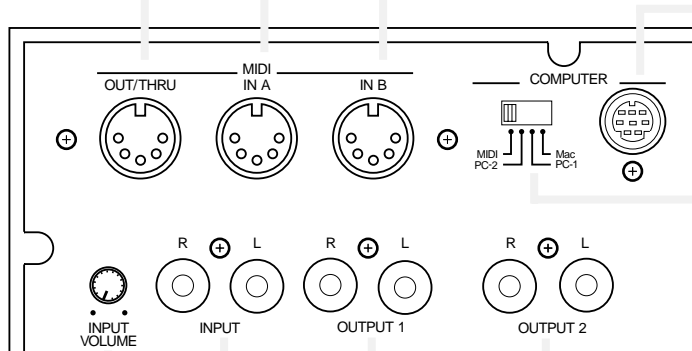

- Computer connector
A special computer cable (sold separately) can be connected here. The type of cable required will depend on your computer. When the Computer switch located at the left is set to MIDI, the computer connector cannot be used (p.120).

- Computer switch
Set this switch depending on the type of computer connected to the Computer connector, or the software you are using. Turn the power off before changing the setting of this switch. If you wish to use the MIDI connectors, set this switch to MIDI. (p.120)

- Audio output 1 jacks (p.8)
- Audio input jacks (p.15)
- Audio input volume knob (p.15)

- Audio output 2 jacks
At the factory settings, no sound will be sent from output 2 jacks. (p.29)

Chapter 1

**Try out the unit
(Quick start)**

■ Connect a MIDI keyboard and play the sounds

● Making connections

- * This section explains how to connect this unit to a MIDI keyboard and play the sounds. If you wish to connect a sequencer or personal computer to this unit, refer to p.120.
- * To prevent malfunction and/or damage to speakers or other devices, always turn down the volume, and turn off the power on all devices before making any connections.

Set the Computer select switch located on the back of this unit to MIDI.

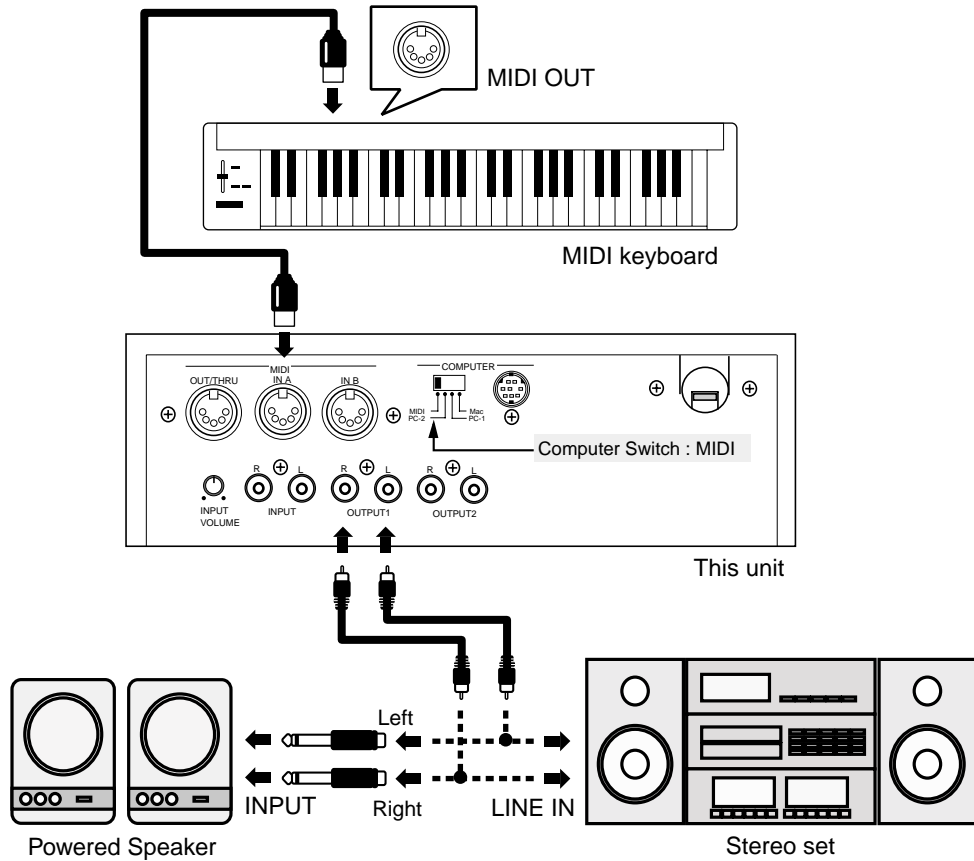

* At the factory settings, no sound will be sent from output2 jacks. (p.29)

● Turning the power on or off

Once the connections have been completed, turn on power to your various devices in the order specified. By turning on devices in the wrong order, you risk causing malfunction and/or damage to speakers and other devices.

○ Turning the power on

1. Before you turn the power on, check the following points.

Make sure that the power cables of each device are correctly plugged into an AC outlet.
Make sure that this unit is correctly connected to any peripheral devices you are using (p.8).
Make sure that the volume of your amp/speaker system and this unit is turned down.

2. Turn on the power of this unit and your MIDI equipment.

3. Turn on the power of your audio system.

Set your amplifier to an appropriate volume.

- * This unit is equipped with a protection circuit. A brief interval (a few seconds) after power up is required before the unit will operate normally.
- * Excessive volumes can damage your speaker system. Please be aware that speakers used in conventional stereo systems are more vulnerable to being damaged by high volume levels than are speakers designed for musical instruments.
- * Is this unit is placed at an angle where the display is difficult to read, adjust the LCD Contrast (p.38).
- * To restore the factory settings, refer to p.118.

○ Turning the power off

1. Before you turn the power off, check the following points.

Make sure that the volume of your amp/speaker system and this unit is turned down.

2. Turn off each device in the following order.

Audio devices → this unit and MIDI devices

● Is there sound?

After making connections as explained in “Making connections”, turn the power on, and gradually raise the volume while playing the keyboard. Does the bar indicator of this unit move? If it does, this unit is receiving MIDI messages correctly.

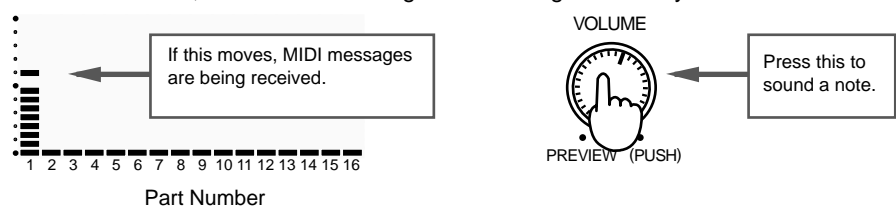

This unit will sound a note when the Volume knob is pressed (the Preview function). If playing your keyboard produces no sound, you can use this function to see whether the amp volume and speaker connections are correct.

If this unit bar indicator does not move, MIDI messages are not being received from your MIDI keyboard. Check your MIDI keyboard settings and MIDI cable connections.

- * With the factory settings, this unit will produce sound in response to any channel 1 — 16, regardless of the transmit channel your keyboard is set to (p.130). This is because each Part is assigned to the correspondingly numbered MIDI channel. The number below the bar indicator is the Part number.
- * If you hear sound but the bar indicator does not move, press the [ALL] button to make the [ALL] indicator light. Now the volume levels of all the Parts of this unit will be indicated in the display (p.23).

■ Try out the various sounds

This unit contains a wide variety of sounds, including not only musical instruments such as piano, organ and guitar, but also sound effects such as birds and telephone rings. In this unit, each of these sounds is called an "Instrument". A group of Instruments is called a "Map."

This unit has three maps; a Native map which contains original sounds, an SC-55 map which contains almost the same sounds as the SC-55/SC-55mkII, and an SC-88 map which contain the same sounds as the SC-88. (p.21, 154)

Here's how to select instruments or maps to try out the sounds.

- 1. Make sure that the [ALL] indicator is dark.**
If it is lit, press the [ALL] button to turn it off.
- 2. Use INSTRUMENT [l] [r] to select sounds. Play and listen the sounds of the Native map.**
Pressing INSTRUMENT [l] will move to a lower-numbered sound, and pressing INSTRUMENT [r] will move to a higher-numbered sound.
While holding down the [r] ([l]) button, press the [l] ([r]) button, the value will change faster.
- 3. To select the SC-55 map, or SC-88 map press the [SC-55MAP] button or [SC-88 MAP] button to make the indicator light.**

Use the INSTRUMENT [l] [r] buttons to select instruments, and listen the sound of the SC-55 map or SC-88 map.

When SC-55 map sounds are selected, a "H" mark will be displayed at the left of the instrument name.

```

PART  INSTRUMENT
A01  001  "Piano 1
LEVEL  PAN  :
100    0  :
```

When SC-88 map sounds are selected, a "S" mark will be displayed at the left of the instrument name.

```

PART  INSTRUMENT
A01  001  'Piano 1
LEVEL  PAN  :
100    0  :
```

If the indicator is dark, the Native map will be selected.

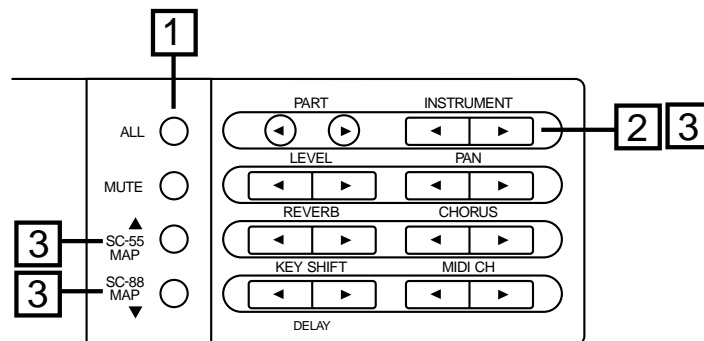

* If you press a sound select button on your MIDI keyboard, this unit's sound will change.

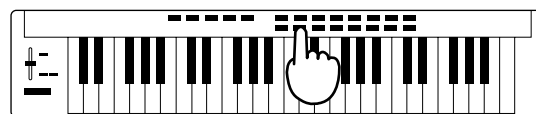

MIDI keyboard

■ Try out the buttons of the unit

● Preview the sound (Preview)

When you press the Volume knob, the currently selected instrument will sound. You can specify the pitch and volume at which this preview note will be sounded (p.37). This preview function is convenient when you wish to check sounds or adjust the tuning when a keyboard is not connected.

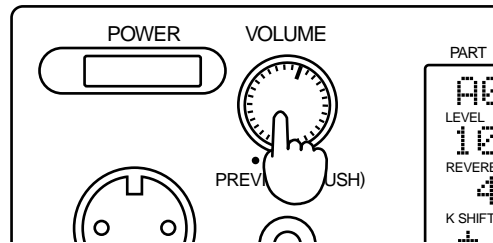

The following procedures must be performed with the [ALL] button indicator dark. If it is lit, press the [ALL] button to turn it off.

● Volume adjustments

Volume adjusts the loudness of the sound. Press LEVEL [r] to increase the volume, and press LEVEL [l] to decrease the volume.

● Pan adjustments (stereo position)

Pan sets the stereo position of the sound when a stereo playback system is used. Use the PAN [l] [r] buttons to set the pan. For example, the drum set and bass might be placed in the center, the guitar at right, and the keyboard at left. To place a sound in the center, set the Pan value to 0. As the L-value increases the sound will be placed further left, and as the R-value increases the sound will be placed further right. If you continue pressing PAN [l], "Rnd" (random) will be selected, and each note will be placed at a random stereo position.

- * For some instruments, small amounts of leakage may be heard from the opposite speaker even when pan has been set fully left or right.
- * If you are listening in mono, pan settings will have no effect.

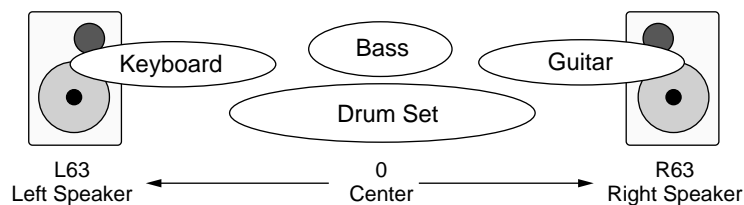

● Transpose the pitch

You can transpose the pitch of the sound in semitone steps. Pressing KEY SHIFT [l] will lower the key (pitch), and pressing KEY SHIFT [r] will raise the key (pitch).

* The area of the screen where the Key Shift setting is displayed is shared with the Delay display. When while holding down the [SC-88 MAP] button, press [DELAY] buttons, the delay setting will be displayed, and when you press the [KEY SHIFT] buttons the key shift setting will be displayed. If the display indicates a +/- (plus or minus) value, the key shift setting is being displayed. (p.13)

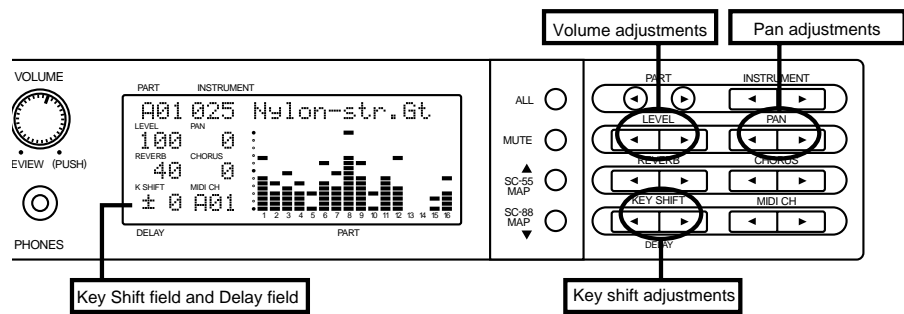

■ Apply effects to the sound

Effects are used to electrically process the sound in various ways to add a different character to the sound. The effects of this unit can be classified either as System effects (p.48) or as Insertion effects (p.56). System effects include 8 types each of reverb and chorus, 10 types of delay, and 2-band equalizer. Insertion effects include 64 effect types. In addition, you can make appropriate parameter settings for each effect, providing varied and detailed control over the sound.

Now let's apply a System effect.

● Adjust the amount of reverb

Reverb is an effect that adds spacious reverberance to the sound, simulating a performance in an acoustically live concert hall. Pressing REVERB [l] decreases the reverb depth, and pressing REVERB [r] increases the reverb depth.

● Adjust the amount of chorus

Chorus is an effect that adds depth and richness to the sound. Pressing CHORUS [l] decreases the chorus depth, and pressing CHORUS [r] increases the chorus depth.

● Adjust the amount of delay

Delay is an effect that delays the sound to create echoes. Also, you can add a short delay to the original sound to give depth and space to the sound. While holding down the [SC-88 MAP] button, press DELAY [l], decreases the volume of the delayed sound, and while holding down the [SC-88 MAP] button, press DELAY [r], increases the volume of the delayed sound.

* The area of the screen where the Delay setting is displayed is shared with the Key Shift display. When while holding down the [SC-88 MAP] button, press [DELAY] buttons, the delay setting will be displayed, and when the [KEY SHIFT] buttons are pressed the key shift setting will be displayed. If the display indicates a +/- (plus or minus) value, the key shift setting is being displayed. (p.12)

* When the EFX indicator is dark, you can also set the delay by pressing EFX TYPE [l][r].

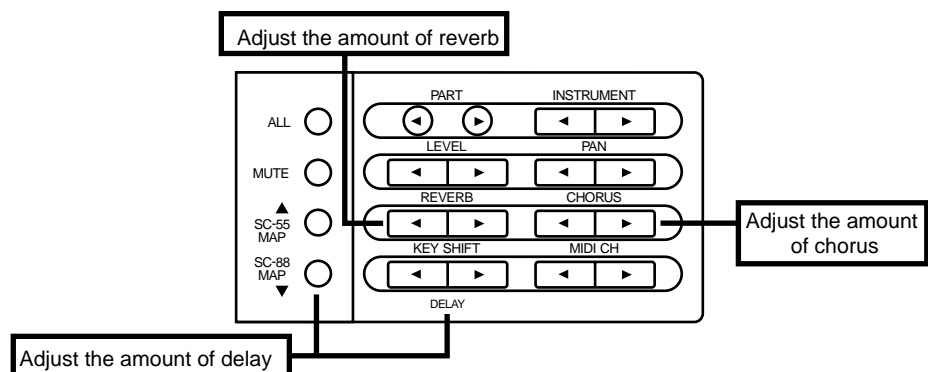

■ Tuning to other instruments (Tuning)

○ M. Tune (Master Tune) 415.3 — 466.2 Hz

When you are playing in an ensemble with other instruments or need to set this unit to match the pitch of another instrument, adjust the Master Tune setting. The displayed value (e.g., 440.0 Hz) indicates the frequency of the A4 note's pitch (note number 69).

Tuning procedure

1. Press [ALL] to make the button indicator light.
2. Simultaneously press both the PART [l] [r] buttons.
3. Press [u] or [d] to select "M. Tune"



4. As you listen to the sound, use INSTRUMENT [l] [r] to adjust the pitch of this unit to match the pitch of the other instrument.
Pressing [l] will lower the pitch, and pressing [r] will raise the pitch. The display will show the frequency of the pitch, so if you are tuning to a specific frequency you can visually check the desired value.
5. When you have made the desired setting, simultaneously press both the PART [l] [r] buttons.

* It is also possible to set the tuning independently for each Part (p.28).

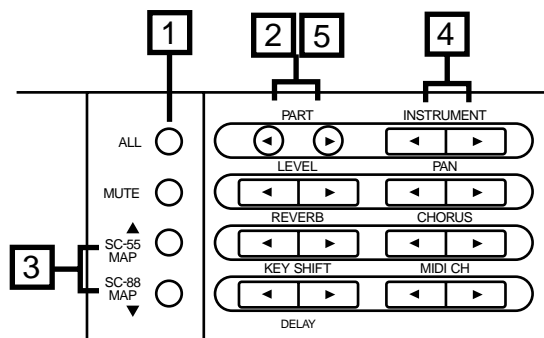

■ Headphones

Use headphones of 8 — 150 ohms impedance. Sound will be output from the audio output jacks even when headphones are connected.

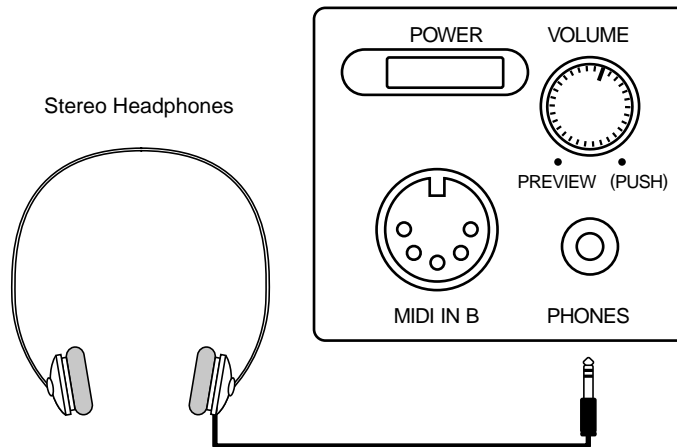

* The headphone jack will output the sound of OUTPUT1. This means that the sound of Parts assigned to OUTPUT2 will not be heard from the headphone jack.

■ Audio input jacks / Audio input volume

You can connect the output jacks of other MIDI sound sources to these jacks. The audio signal that is input here will be mixed with this unit's sound and output from the audio output1 jacks.

If the signal input to this unit is too large or too small, use the audio input volume knob to adjust it. If the input signal is too large, rotate the knob to the left to reduce the volume.

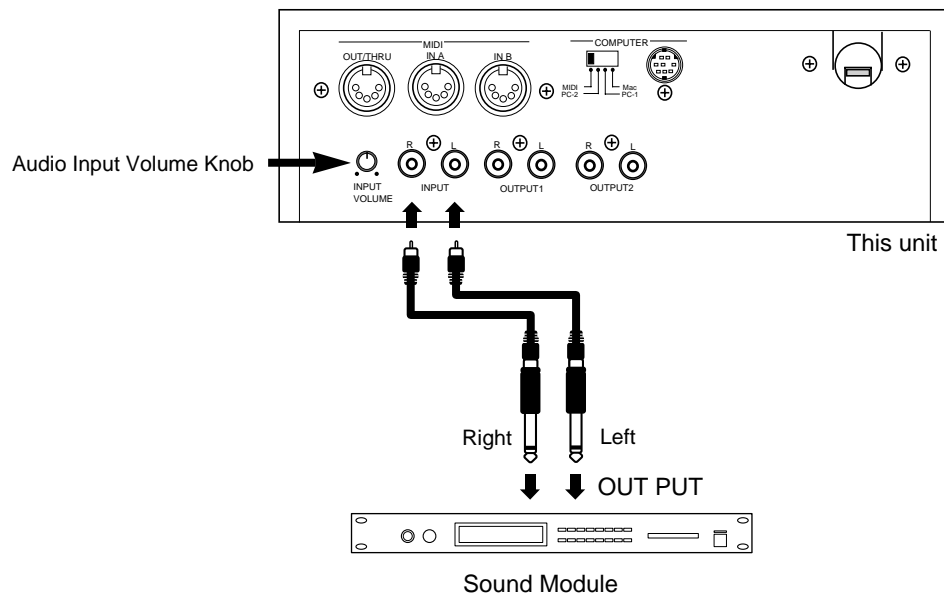



Chapter 2

Parts and parameters

■ Parts and sounds

This unit is able to produce 32 different types of sound at once. An instrument such as this unit, which can simultaneously produce many sounds from a single unit's is called a multi-timbral sound generator. A Timbre is an instrumental sound. Being able to simultaneously play 32 sounds means that you can use 32 different instruments at once. In other words, you can create an orchestra-like ensemble of 32 musical parts. In this unit, the sound selected for each Part is called an Instrument. (Instrument chart, p.154) You can assign the sounds you want to each of 32 Parts to create your own ensemble.

There are two types of Parts: Normal Parts and Drum Parts. We refer to this difference as the Part mode (p.27). Normal Parts are used for playing melody or bass lines. Drum Parts are used for playing percussion instruments.

This unit has three maps; a Native map which contains original sounds, an SC-55 map which contains almost the same sounds as the SC-55/SC-55mkII, and an SC-88 map which contain the same sounds as the SC-88. (p.21, 154)

Here's how to select instruments or maps to try out the sounds.

* For details about Part Mode, refer to p.27.

● Assigning a sound to a Part

1. Make sure that the [ALL] indicator is dark.

If it is lit, press the [ALL] button to turn it off.

2. Use the PART [l] [r] buttons to select the Part for which you want to specify a sound.

As you press the PART [l] [r] buttons, the screen display indicating the Part numbers will change "A01..A16 B01..B16". If you select the Drum Part, an "*" will be displayed in front of the Drum Set name.

* To switch between the group A and B, simultaneously press both [ALL] and PART [l] [r].

```
PART  INSTRUMENT
A01  026*TR-808
LEVEL  PAN  :
100   0  :
```

3. Use the INSTRUMENT [l] [r] buttons to select the sound (Instrument) for each Part.

For the Drum Part, a Drum Set will be selected.

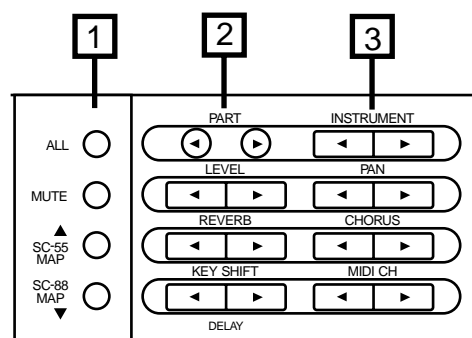

○ To select the same sounds as the SC-55/SC-55mk II

4-1. Press [SC-55 MAP], and the sound for that Part will be almost the same as the SC-55/55mk II.

At this time "1" will be displayed in front of that Instrument name.



* It is also possible to select the CM-64 Instrument layout. (p.114)

○ To select the same sounds as the SC-88

4-2. Press [SC-88 MAP], and the sound for that Part will be the same as the SC-88.

At this time "2" will be displayed in front of that Instrument name.

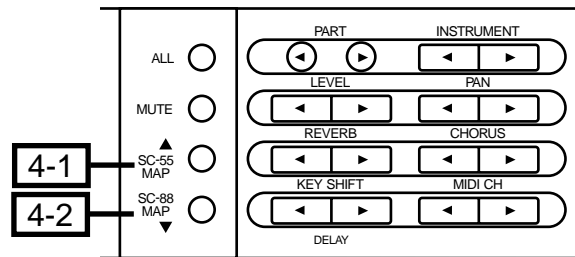

- * To select Part sounds or Drum Sets from another MIDI device, refer to p.126.
- * Some of the sounds in this unit cannot be played above (or below) a certain pitch. This is because the sounds have been created with the pitch ranges of actual instruments in mind.
- * You can edit sounds to suit your taste and store them as User sounds. (p.96)

● Selecting Variation sounds

Each of the three sound maps of this unit contains Capital sounds (basic sounds) and Variation sounds (sounds with different nuances). The procedure explained on the previous page selects Capital sounds (128 sounds; Instrument list, p.154). Here's how to select Variation sounds.

- 1. Make sure that the [ALL] indicator is dark.**
If it is lit, press the [ALL] button to turn it off.
- 2. Use the PART [l] [r] buttons to select the Part for which you want to choose a Variation sound.**
- 3. Simultaneously press both INSTRUMENT [l] [r] buttons to enter Variation select mode.**
The Variation number and a “/” symbol will be displayed in front of the Instrument name.

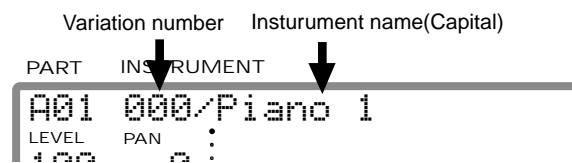

- 4. Press INSTRUMENT [l] or [r] to change the Variation number.**

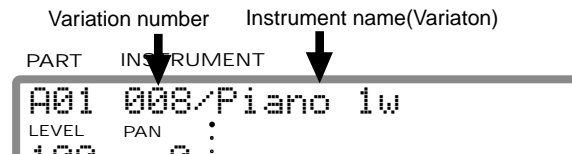

- 5. To exit Variation select mode, simultaneously press both the INSTRUMENT [l] [r] buttons. You will return to normal mode (the Instrument number is displayed).**

In this condition, pressing INSTRUMENT [l] or [r] will change the instrument number.

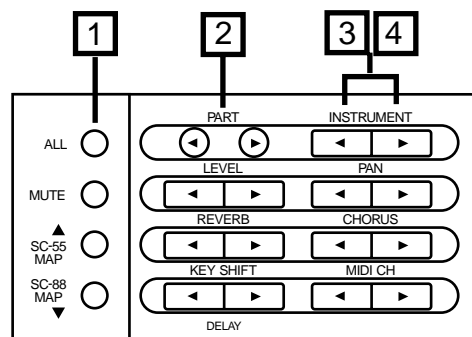
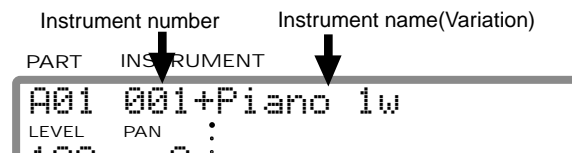

- * Some Variation numbers are not consecutive.
- * If the Part is set to a Drum Part (p.18, 27), the Variation number will not change. This is because Drum Sets do not have Variations.
- * Sounds compatible with the CM-64 are Variation sounds in the SC-55 map. Original sounds you create (p.96) are Variation sounds in the Native map and SC-88 map.
- * If the indicator of EFX is dark, you can also use EFX PARAM[l] [r] to select the Instrument sound, and EFX VALUE[l] [r] to select the Variation sound.

A symbol will be displayed in front of the sound name to indicate the type of sounds you are selecting.

- blank Capital sounds (Variation number 000)
- "+" Variation sounds (Variation number 001 — 125)
- "?" SC-88 sounds (SC-88 map)
- "!" SC-55/55mk II sounds (SC-55 map)
- "#" CM-64 compatible sounds (Variation number 126, 127 in the SC-55 map)

PART INSTRUMENT A01 001 Piano 1 LEVEL PAN : 100 a :	← Capital sounds
PART INSTRUMENT A01 001+Piano 1w LEVEL PAN : 100 a :	← Variation sounds (Instrument number is displayed)
PART INSTRUMENT A01 008/Piano 1w LEVEL PAN : 100 a :	← Variation sounds (Variation number is displayed)
PART INSTRUMENT A01 001 ?Piano 1 LEVEL PAN : 100 a :	← SC-88 sounds
PART INSTRUMENT A01 001 !Piano 1 LEVEL PAN : 100 a :	← SC-55/55mkl sounds
PART INSTRUMENT A01 001#Piano 1 LEVEL PAN : 100 a :	← CM-64compatible sounds

● Reading the Instrument numbers and Variation numbers

Each sound (Instrument) of this unit has two numbers; an Instrument number and a Variation number. Sounds with Variation number 000 are Capitals, and the sounds with numbers other than 000 are Variations.

In normal displays, the Instrument numbers will be displayed. The display screen on this unit can show either the Instrument number or the Variation number, not both.

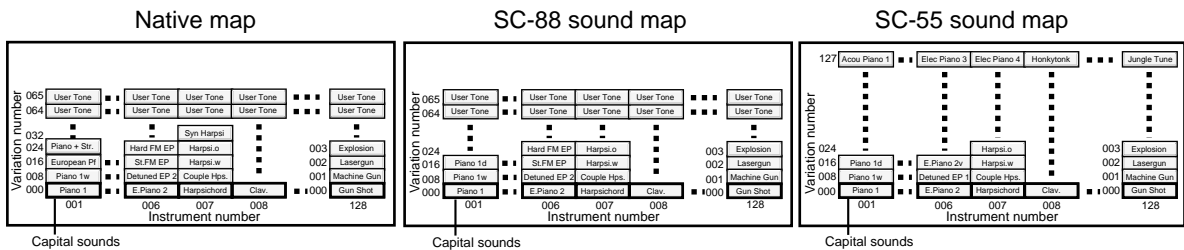

● Part Channels

To each of this unit's 32 Parts, there is assigned an instrument and also a Channel. Channels are a concept used in MIDI to distinguish notes that should be played by different instruments in an ensemble. Normally, there is no need to change the channel of a Part when using this unit. However it may sometimes be interesting to set two Parts to the same channel so that two sounds will simultaneously play the same musical line. To change the MIDI channel of a Part, use the following procedure.

* For detail about MIDI, refer to p.130.

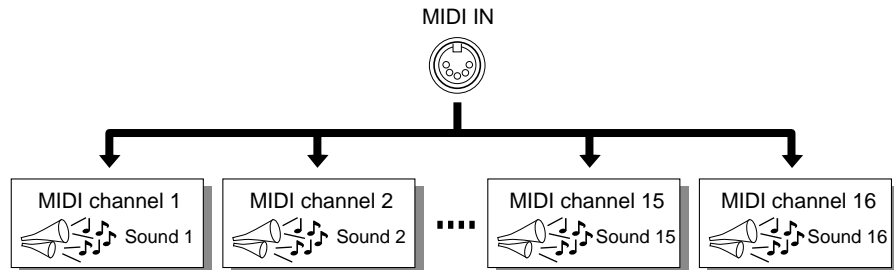

Procedure

1. Make sure that the [ALL] indicator is dark.

If it is lit, press the [ALL] button to turn it off.

* If you operate the MIDI CH [l] [r] buttons while the [ALL] indicator is lit, the MIDI channel of a Patch (p.41) will be changed. Be careful.

2. Use the PART [l] [r] buttons to select the Part whose channel you wish to change.

When you press the PART [l] [r] buttons, the Part number will change as "A01..A16 B01..B16". If you select a Drum Part, a "*" mark will appear in front of the Drum Set name.

3. Use the MIDI CH [l] [r] buttons to set the MIDI channel of the Part.

When you press the MIDI CH [l] [r] buttons, the MIDI channel will change as "A01..A16 A-- B01..B16 B--". Select the desired MIDI channel. Parts for which you select "A--", "B--" will ignore all MIDI messages except Exclusive messages.

* To switch between the A and B, simultaneously press both KEY SHIFT [r] and MIDI CH [l]

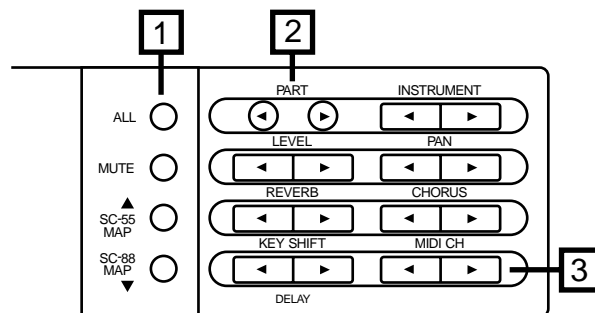
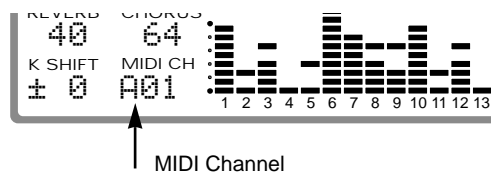

● Which MIDI IN will be used by each Part?

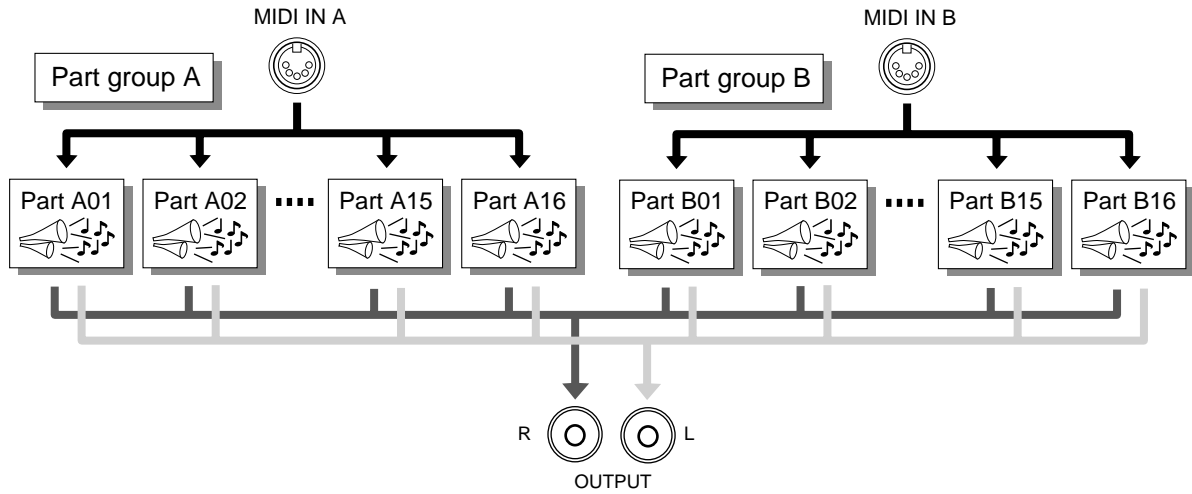

This unit has two MIDI IN jacks. This is because since there are only 16 MIDI channels, it is necessary to have two MIDI jacks in order to play 32 Parts.

Parts are classified into Group A (A01 — A16) and Group B (B01 — B16), with sixteen in each group. The MIDI channel assigned to each Part is also displayed in two groups as A01 — A16 or B01 — B16. With the factory settings, groups A and B correspond to this unit's two MIDI IN jacks A and B. In other words, MIDI messages received at MIDI IN A are sent to the group A Parts, and MIDI messages received at MIDI IN B are sent to the group B Parts. For example, a MIDI message on channel 5 received at MIDI IN B will sound Part 5 of Group B (B05) (with the factory settings).

* Be aware that the way in which the data is sent from the two MIDI IN jacks to the various Parts will depend on the setting of the System parameter Receive Connection (Input Modes p.137). Also, Exclusive messages received at MIDI IN A can be passed on to Parts of group B, depending on the specified address. (p.128, 193)

If the [ALL] button has been pressed to turn on the [ALL] indicator, the volume levels of the 32 Parts will be graphically displayed as shown below when this unit is played. This graphic display allows you to monitor the reception for each Part.

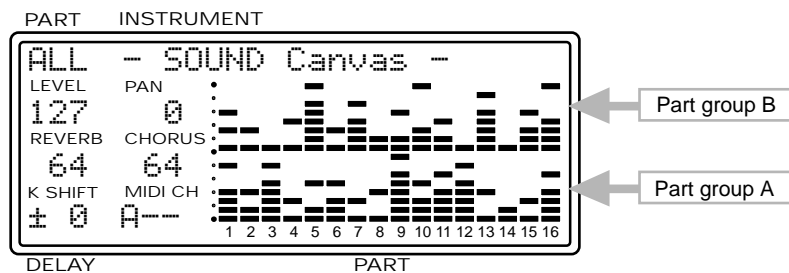

● How simultaneous note numbers and Voices are related

The sounds of this unit consist of units called “Voices”. There is a limit to how many of these “Voices” can sound at once, and in the case of this unit, up to 64 simultaneous voices can be used. Some sounds (Instruments) use 1 voice and others use 2 voices (Instrument list, p.154). The main reason that some sounds use 2 voices is to allow different timbres to be produced by different velocity values.

If more than 64 voices are used at once, later-sounded notes will be given priority, and notes sounded previously will be turned off starting from the oldest. If you use only single-voice instruments, you will be able to play 64 notes simultaneously, but if some of the instruments are 2-voice, you will be able to play less than 64 simultaneous notes. Even if a MIDI Note Off message (p.131) is received, voices will be used for as long as the sound is heard. Be aware of this especially in the case of sound with a long release (p.33).

* If song data created with 64 voice playback in mind is played back on a sound source with fewer voices, some notes will drop out, and the musical result will not be as it should. The SC-55 has 24 voices, and the SC-55mkII has 28 voices.

● Concerning legato-enabled sounds

This unit provides legato-enabled sounds that are ideally suited to legato playing, and which can realistically simulate this instrumental performance technique.

To understand this feature, consider how most string instruments produce sound. Usually, a brief attack-like sound will be heard only at the very instant the string is made to vibrate. After that a much mellower, attack-free sound continues to emanate during the string’s vibration. The legato-enabled sounds simulates such variable attack-portion characteristics of string sounds by switching on or off certain special voices within an Instrument according to the way the keyboard is played.

Instrument which has a “L” at the end of its name (such as “Violin:L”) is the legato-enabled sound.

Try out one of these Patches to hear how it works. If you are using a keyboard, play a note and keep your finger on that key while playing another note.

You should hear a distinct attack portion with the first note you play, while the second one contains almost no attack components, and sounds much smoother.

At this time, “L” will be displayed following “L” of the instrument name.

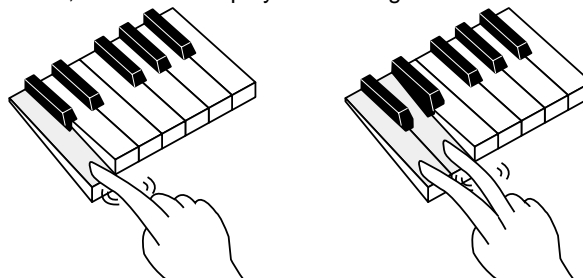

If you want to sound the attack portion each time, simply release your finger from a key before playing the next note.

At this time, “L” will not be displayed following “L” of the instrument name.

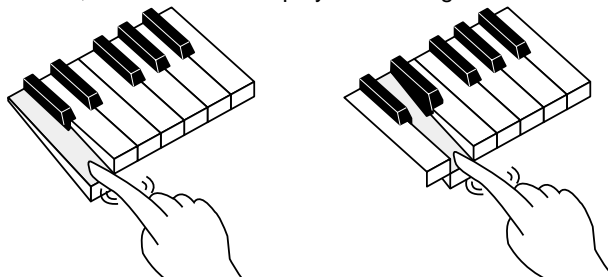

* Legato Control cannot be switched on and off on an Instrument basis. You should choose and edit an Instrument that meets your intended usage.

■ Part parameters for performance

These parameters determine how each Part behaves when it receives MIDI messages. The way in which the sound changes in response to messages such as velocity, pitch bend, modulation and aftertouch will be determined by the settings of these parameters.

[1] Parameters that can be set directly using the buttons

LEVEL [l] [r]	: set the volume of each Part
PAN [l] [r]	: set the pan of each Part
KEY SHIFT [l] [r]	: transpose each Part
[MUTE]	: mute each Part (Part Mute)
[ALL]*[MUTE]	: monitor each Part (Part Monitor)
[SC-55 MAP]	: set each Part to almost the same sounds as the SC-55/55mk II
[SC-88 MAP]	: set each Part to the same sounds as the SC-88.

* indicates that both buttons must be pressed simultaneously.

● Procedure

1. Make sure that the [ALL] indicator is dark.

If it is lit, press the [ALL] button to turn it off.

* If you wish to change the volume (for example) of all Parts simultaneously, press the [ALL] button to make the indicator light, and continue the following procedure. (p.34)

2. Use the PART [l] [r] buttons to select the Part whose setting you wish to change.

3. Use the parameter buttons on the front panel to change the setting. The setting will be displayed in the appropriate part of the screen.

4. When you press the LEVEL, PAN and KEY SHIFT [l] [r] buttons simultaneously, the current setting will be shown graphically on the screen.

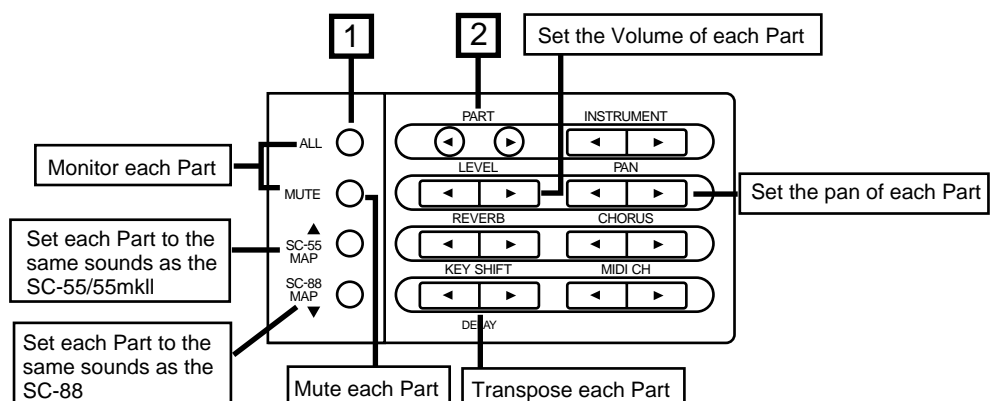

[2] Parameters that must be selected from the menu

The following parameters can be selected.

Part EQ	(Part Equalizer)	Bnd Range	(Bend Range)
Part Mode	(Part Mode)	Bnd Cutoff	(Bend Cutoff)
M/P Mode	(Mono/Poly Mode)	Bnd Amp	(Bend Amplitude)
Fine Tune	(Fine Tune)	Bnd LFO Rate	(Bend LFO Rate)
Rx Bank Sel	(Bank Select Receive Switch)	Bnd LFO Pch	(Bend LFO Pitch)
Rx NRPN	(NRPN Receive switch)	Bnd LFO TVF	(Bend LFO TVF)
		Bnd LFO TVA	(Bend LFO TVA)
Velo Depth	(Velocity Sens Depth)	CAf Range	(Channel Aftertouch Range)
Velo Offset	(Velocity Sens Offset)	CAf Cutoff	(Channel Aftertouch Cutoff)
K.Range L	(Keyboard Range Low)	CAf Amp	(Channel Aftertouch Amplitude)
K.Range H	(Keyboard Range High)	CAf LFO Rate	(Channel Aftertouch LFO Rate)
CC1 C.Number	(CC1 Controller Number)	CAf LFO Pch	(Channel Aftertouch LFO Pitch)
OUT Asgn	(Output Assign)	CAf LFO TVF	(Channel Aftertouch LFO TVF)
		CAf LFO TVA	(Channel Aftertouch LFO TVA)
S.Tune C - B	(Scale Tuning C-B)		
Mod Range	(Modulation Range)	CC1 Range	(CC1 Range)
Mod Cutoff	(Modulation Cutoff)	CC1 Cutoff	(CC1 Cutoff)
Mod Amp	(Modulation Amplitude)	CC1 Amp	(CC1 Amplitude)
Mod LFO Rate	(Modulation LFO Rate)	CC1 LFO Rate	(CC1 LFO Rate)
Mod LFO Pch	(Modulation LFO Pitch)	CC1 LFO Pch	(CC1 LFO Pitch)
Mod LFO TVF	(Modulation LFO TVF)	CC1 LFO TVF	(CC1 LFO TVF)
Mod LFO TVA	(Modulation LFO TVA)	CC1 LFO TVA	(CC1 LFO TVA)

● Procedure

- 1. Make sure that the [ALL] indicator is dark.**
If it is lit, press the [ALL] button to turn it off.
- 2. Simultaneously press both the PART [l] [r] buttons.**
- 3. Use the PART [l] [r] buttons to select the Part whose settings you wish to modify.**
- 4. Press [u] or [d] to select the parameter you wish to modify.**
While holding [SELECT], you can press [u][d] to jump to the Part EQ, S.Tune C, Mod Range, Bnd Range, CAf Range, CC1Range, and CC1 LFO TVA parameters.

```

PART  INSTRUMENT
A01 >Part Mode: Norm
LEVEL  PAN  :
100    a  :
  
```

- 5. Use the INSTRUMENT [l] [r] buttons to set the value.**
- 6. When you finish making settings, simultaneously press both the PART [l] [r] buttons to end the procedure.**

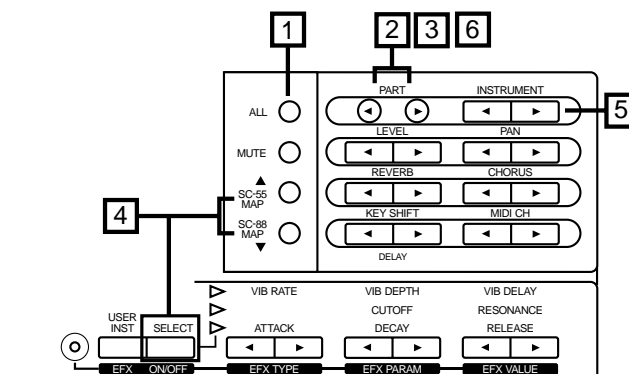

● What each parameter does

○ LEVEL (Volume level): 0 — 127

This parameter adjusts the volume of each Part. Higher values result in a louder sound.

○ PAN (Panning): Rnd, L63 — 0 — R63

Pan refers to the position in the stereo field. For example, you might place the drum set and bass in the center, the guitar at the right, and the keyboard at the left. To place the sound in the center, set this value to 0. As the L-number increases the sound will move further to the left, and as the R-number increases the sound will move further to the right. With a setting of “Rnd” (random), each note will be placed at an unpredictable location.

- * In the case of a Drum Set, the pan position has been fixed for each percussion instrument. Adjusting the Pan of a Drum Set will shift the overall set to left or right.
- * For some instruments, some sound may be heard from the opposite speaker even if Pan has been set fully left or right.
- * If your amp/speaker system is mono, Pan will have no effect.

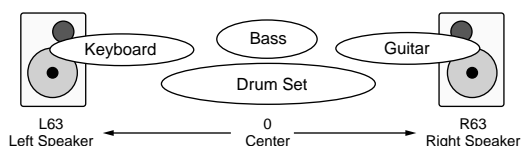

○ KEY SHIFT: -24 — ± 0 — +24: semitone steps, 2 octaves

This parameter transposes the Part. As the value increases (decreases) the pitch will rise (fall) in steps of a semitone. 12 steps make a difference of 1 octave. With a setting of 0 the pitch will not be affected.

○ MUTE (Part Mute): On/Off

This function allows you to mute the sound of a specific Part so that it will not be heard. When the [MUTE] button is pressed to turn on the indicator, Part Mute will be turned on. When playing back a recorded ensemble from a sequencer etc., it is sometimes convenient to mute one of the Parts and play the missing part yourself. The lowest dot on the bar display indicates the mute on/off status of each Part. The dot will be off for Parts whose Part Mute is turned on.

- * If All Mute (p.35) is on, the lowest dot in the bar display will be off for all Parts, regardless of their Part Mute on/off setting.
- * When a GM System On or GS Reset message (p.133) is received, muting will be canceled. If you do not wish mute to be canceled, turn on Mute Lock (p.139).

○ SC-55 Map (Part SC-55 MAP): On / Off

When the [SC-55 MAP] button is pressed to turn on the indicator, the sound of the currently selected Part will change to be almost the same as the SC-55/55mk II.

At this time, “!” will be displayed in front of that Instrument name.

○ SC-88 MAP(Part SC-88 MAP):On/Off

When the [SC-88 MAP] button is pressed to turn on the indicator, the sound of the currently selected Part will change to be the same as the SC-88.

At this time, “?” will be displayed in front of that Instrument name.

○ Part Monitor: On/Off

Part Monitor can be turned on when you want to listen to only one or more Parts that you select. This feature conveniently allows you to listen to only the instruments you want to hear during sequenced playback. To turn it ON, simultaneously press both [ALL] and [MUTE]. The indicator on MUTE will blink on and off while the feature is on.

- * While you have the Part Monitor on, you can press EFX PARAM [r] (in the panel's bottom row) to listen to some other Part you want to hear. The volume ratio of some other parts is displayed in the MIDI CH column.
- * With Part Monitor on, you can add extra Parts that you want to monitor by using PART [I] [r] to select Parts, then pressing EFX VALUE [r]. Press EFX VALUE [I] to cancel whatever choices you have made.

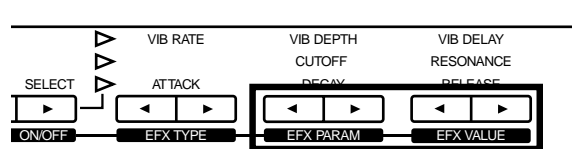

○ Part EQ: On/Off

Equalizer on/off can be set for individual Parts. Part equalizer will be on, and the equalizer will be applied to the sounds of parts. Part equalizer will be off, and the equalizer will not be applied to the sounds of parts.

- * For the procedure of making Equalizer settings, refer to p.48.
- * With the factory settings, equalizer gain is set at 0. This means that the equalizer will have no effect even if the Part EQ is on.

○ Part Mode: Norm/Drum1/Drum2

For Parts which are playing conventional instrument sounds, select Norm (Normal mode). For Parts which are playing percussion or drums, select Drum1 or Drum2. Drum Parts play a different sound (Instrument) for each different MIDI note number (p.131). In other words, a single Part can play many different percussion instrument sounds (Drum set list p.163).

The Drum1 and Drum2 Parts allow you to simultaneously use two drum sets. For example if Drum Parts are set as shown below, when you change the STANDARD1 drum set of Part A10 to the TR-808, the selection for Part A12 will also change to TR-808. For details on how to assign a drum set to a Part, refer to p.18.

Part name	(Part Mode)	Name of drum set
Part A10	(Drum1) :	STANDARD 1
Part A11	(Drum2) :	JAZZ
Part A12	(Drum1) :	STANDARD 1

M/P Mode (Mono/Poly Mode): Mono/Poly

If a Part is set to Mono (Mono Mode), that Part will play only one note at a time. It is effective to select Mono Mode for parts that are playing a naturally monophonic instrument such as a trumpet or sax. Select Poly Mode for Parts that are playing chords.

** For a Drum part, changing the Mono/Poly Mode setting will not affect the sound.*

Fine Tune: -100.0 — +100.0 cent

Use this parameter when you wish to make fine adjustments to the tuning of a Part. Positive (+) settings will raise the pitch, and negative (-) settings will lower the pitch. If two or more Parts are set to the same MIDI channel and the same sound, you can spread their Fine Tuning settings apart to add rich depth and breath to the sound.

** To adjust the pitch of all Parts, use the Master Tune parameter (p.14).*

** To transposes the Part, use the KEY SHIFT parameter (p.25).*

Rx Bank Sel (Bank Select Receive Switch): On/Off

Rx NRPN (NRPN Receive Switch): On/Off
For details of these two parameters, refer to p.141.

Velo Depth (Velocity Sensitivity Depth): 0 — 127

Velo Offset (Velocity Sensitivity Offset): 0 — 127

The force with which you play a note on MIDI keyboard is transmitted as MIDI Velocity data. Strongly played notes will have a higher velocity value. The Velo Depth and Velo Offset parameters determine the relation between the force of your keyboard playing and the loudness of the sound that results.

If Velo Depth is increased, small differences in your playing dynamics will make a large difference in the loudness of the sound (Fig.3). If Velo Depth is decreased, even large differences in your playing dynamics will make only a small difference in the loudness of the sound (Fig.2).

If Velo Offset is set higher than 64, even softly played notes (i.e., notes with a low velocity) will be sounded loudly (Fig.5). If Velo Offset is set lower than 64, even strongly played notes (i.e., notes with a high velocity) will be sounded softly (Fig.4).

** For some settings, there may be no sound. If so, increase Velo Depth or Velo Offset.*

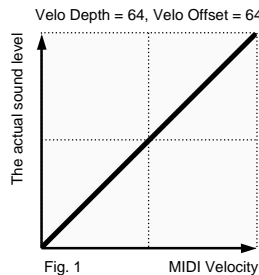

Fig. 1

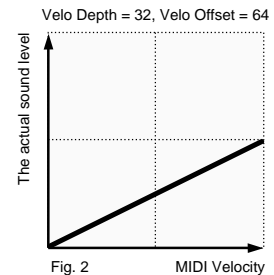

Fig. 2

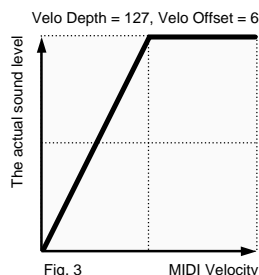

Fig. 3

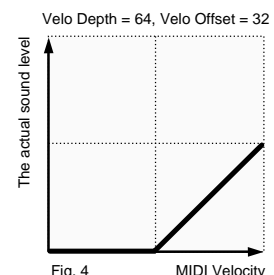

Fig. 4

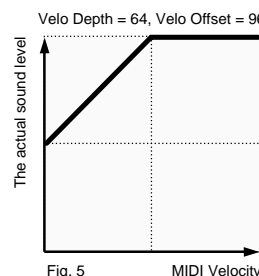

Fig. 5

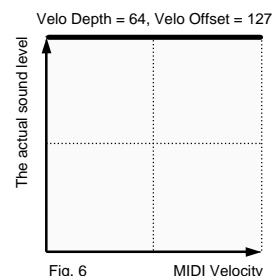
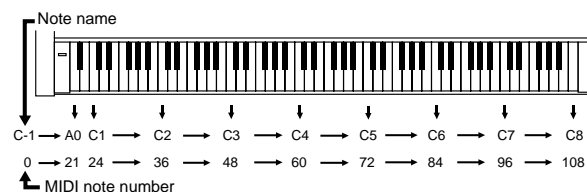

Fig. 6

K. Range L (Keyboard Range Low): C-1 — G9

K. Range H (Keyboard Range High): C-1 — G9

The Key Range parameters determine the pitch range over which the instrument will be sounded. Keyboard Range Low (the lowest note) and Keyboard Range High (the highest note) will determine the range of notes that will sound. These values are displayed as key names. You can specify a value between C-1 and G9 (0 — 127), and middle C is C4 (60).



For example, if you assign two Parts to the same MIDI channel and set the Keyboard Range of one to C-1 — B3 and the other to C4 — G9. Then you could assign different sounds to each Part, and play two different sounds on either side of C4. Or, you could set the keyboard ranges of two Parts to overlap, and layer the two sounds.

* Be aware that if Keyboard Range High is set to a note name lower than Keyboard Range Low, there will be no sound.

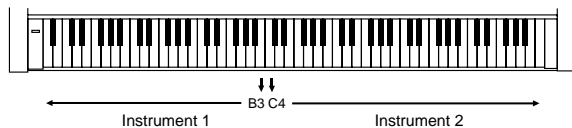

○ **CC1 C.Number (CC1 Controller Number):**
1 — 95

Set the controller number which will control the CC1 parameter (p.30) via MIDI. For example if you set CC1 C.Number to 16, the value of an incoming MIDI controller number 16 message will affect the sound as specified by the setting of the CC1 parameter.

○ **OUT Asgn (Output Assign): OUT-1/2/L/2R**

Specify the output jack from which the sound of each part will be output.

- OUT-1** The sound together with the effect sound will be output in stereo from the OUTPUT 1 jacks.
- OUT-2** The direct sound without the effect sound will be output in stereo from the OUTPUT 2 jacks.
- OUT-2L** The direct sound without effects will be output from the OUTPUT 2L jack. (The Pan setting will have no effect.)
- OUT-2R** The direct sound without effects will be output from the OUTPUT 2R jack. (The Pan setting will have no effect.)

* The headphone jack will output the sound of OUTPUT 1. This means that the sound of Parts assigned to OUTPUT 2 will not be heard from the headphone jack.

* This is valid only when Sys. OUT Mode (p.38) is set to Sel. Be aware that if it is set to Fix, the above settings will be ignored.

* With the factory settings, all Parts are set to OUT-1.

* The sound from OUTPUT 2 is output at a fixed volume, unaffected by the position of the volume knob.

○ **S.Tune C - B (Scale Tuning C - B):**
-64 — +63

Scale Tuning is a parameter which makes fine adjustments to the pitch of each note in the octave. These settings are for one octave of notes, and will simultaneously adjust the pitch of that note in all octaves. By using Scale Tuning, you can perform using a variety of temperaments other than equal temperament. Here we will give three settings as examples.

< **Equal temperament** >

This tuning divides the octave into 12 equal parts, and is the most widely used method of temperament used in western music. The default setting of this unit's Scale Tune function is Equal Temperament.

< **Just intonation (tonic of C)** >

Compared with equal temperament, the principle triads sound pure in this tuning. However this effect is achieved only in one key, and the triads will turn muddy if you transpose. Here is an example of the settings for a tonic of C.

< **Arabian-style scale** >

A variety of ethnic tunings can be achieved by using the Scale Tuning function. Here are settings for a tuning representative of Arabian-style scales

Example settings (values are in units of cents)

Note name	Equal temperament	Just intonation (tonic of C)	Arabian-style scale
C	0	0	-6
C#	0	-8	+45
D	0	+4	-2
D#	0	+16	-12
E	0	-14	-51
F	0	-2	-8
F#	0	-10	+43
G	0	+2	-4
G#	0	+14	+47
A	0	-16	0
A#	0	+14	-10
B	0	-12	-49

○ **Mod ~/Bnd ~/CAf ~/CC1 ~**
Mod ~ (Modulation ~)

When you move the modulation lever or modulation wheel of a MIDI keyboard, modulation messages are transmitted, modifying the sound. The Mod ~ parameters specify the way in which the sound will change when these messages are received. With the factory settings of these parameters, vibrato will be applied to the sound.

Bnd ~ (Bend ~)

When you move the pitch bend lever or pitch wheel of a MIDI keyboard, pitch bend messages are transmitted, modifying the sound. The Bnd ~ parameters specify the way in which the sound will change when these messages are received. With the factory settings of these parameters, the pitch will be modified.

CAf ~ (Channel aftertouch ~)

On some MIDI keyboards, pressing down on the key after a note is played will cause aftertouch messages to be transmitted. (Channel Aftertouch is sometimes called Channel Pressure.) This unit is able to receive these messages and modify the sound in response. The CAf ~ parameters specify the way in which the sound will change when these messages are received. With the factory settings of these parameters, no effect will occur.

** Check whether your MIDI keyboard is able to transmit aftertouch messages.*

CC1 ~ (CC1 ~)

Some MIDI keyboards allow controller numbers to be assigned to the sliders. When these sliders are moved, messages of the specified controller number are transmitted, causing the sound to be modified. The CC1 parameters specify how the sound will change when messages of the corresponding control number are received.

First use the CC1 C.Number parameter (previous page) to select the controller number that you are assigning.

~ Range -24 — +24 (Bend Range is ± 0 — +24)

These parameters specify the maximum pitch change that will occur when the corresponding message is received. A setting of 12 allows 1 octave of change, and a setting of 24 allows 2 octaves of change. With a setting of 0, there will be no pitch change.

** For some sounds, the pitch may not rise as high as specified by the Range setting.*

~ Cutoff (~ Cutoff frequency) -64 — +63

These parameters specify how the cutoff frequency will change when the corresponding message is received. Higher values will cause the cutoff frequency to rise. Positive (+) settings allow the sound to be made brighter, and negative (-) settings allow the sound to be made more mellow.

~ Amp (~ Amplitude) -64 — +63

These parameters specify the way in which the sound will change when the corresponding message is received. Higher values allow a greater increase in volume.

~ LFO Rate (~ LFO Rate) -64 — +63

These parameters specify the way in which the LFO frequency will change when the corresponding message is received, adjusting the speed at which the sound is modulated or varied. Higher values allow the modulation or variation to be speeded up.

~ LFO Pch (~ LFO Pitch) 0 — 127

These parameters specify the way in which the depth of the vibrato effect (cyclic modulation of pitch) will change when the corresponding message is received. Higher values allow the modulation effect to be increased.

~ LFO TVF (~ LFO TVF) 0 — 127

These parameters specify the way in which the depth of the growl effect (cyclic modulation of tone) will change when the corresponding message is received. Higher values allow the growl effect to be increased.

~ LFO TVA (~ LFO TVA) 0 — 127

These parameters specify the way in which the depth of the tremolo effect (cyclic modulation of volume) will change when the corresponding message is received. Higher values allow the tremolo effect to be increased.

** When these settings are at 0, there will be no effect.*

■ Part parameters for sound editing

On this unit, you can modify the values of a variety of parameters in order to create the sound most suitable for your playing. A “parameter” is something that affects the sound. The process of modifying parameter values is called “editing.” Sound parameters affect the volume, timbre and pitch of the sound.

You can set the following parameters.

Vibrato	: Rate	Depth	Delay
Filter	:	Cutoff Frequency	Resonance
Envelope	: Attack Time	Decay Time	Release Time

● Procedure

- 1. Make sure that the [ALL] indicator is dark.**
If it is lit, press the [ALL] button to turn it off.
- 2. Use the PART [l] [r] buttons to select a Part.**
- 3. Press the [SELECT] button to select the parameter (vibrato, filter, envelope) you wish to edit, and use the corresponding set of [l] [r] buttons to modify the value.**
- 4. Simultaneously pressing both [l] [r] buttons used to set Vibrato, Filter or Envelope will cause the setting status of that parameter to appear graphically in the display.**

Simultaneously press both buttons again, and the previous display will reappear.

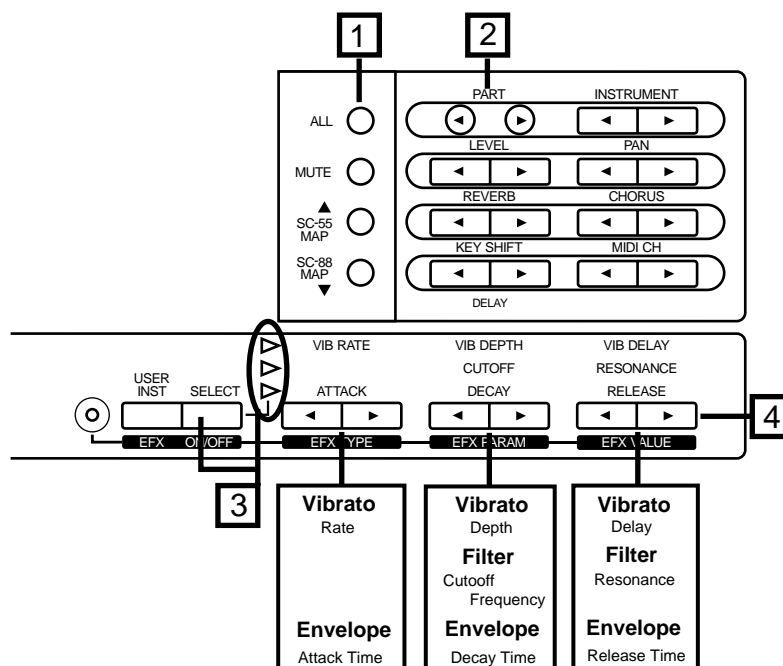

(Example) Vibrato editing display

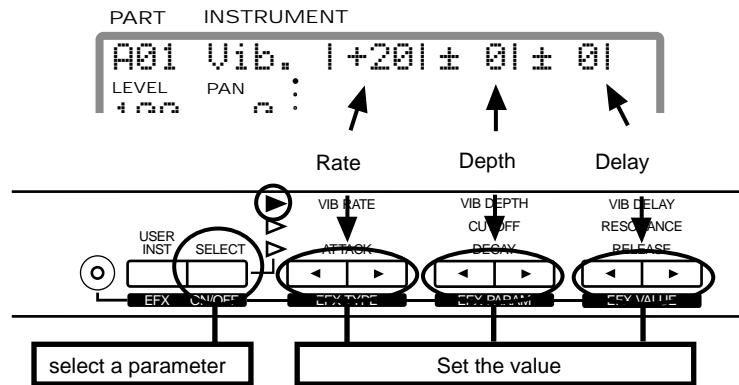

● What each parameter does

On this unit, parameter settings are made for each Part. In other words, parameter values belong to Parts, and not to sounds (Instruments). For example if you set Vibrato Rate to +20 and then select a different sound for that Part, the Vibrato Rate of +20 will apply to the newly selected sound (not the initial value of ± 0). In this way, parameters belonging to Parts are called Part Parameters.

* Parameters such as Vibrato, Filter and Envelope can be set not only for Parts, but also for sounds (Instruments). Sounds you create by modifying these parameters are called User sounds, and can be stored in Native map memory area (p.97).

Vibrato

Vibrato is an effect created by modulating the pitch. Applying vibrato makes the sound more expressive.

○ Vibrato Rate: -64 — +63

This parameter adjusts the speed (frequency) of the pitch modulation. Positive (+) settings make the pitch modulation faster, and negative (-) settings make it slower.

○ Vibrato Depth: -64 — +63

This parameter adjusts the depth of the pitch modulation. Positive (+) settings make the pitch modulation deeper, and negative (-) settings make it shallower.

○ Vibrato Delay: -64 — +63

This parameter adjusts the time required for the vibrato effect to begin. Positive (+) settings increase the time before vibrato will begin, and negative settings shorten the time.

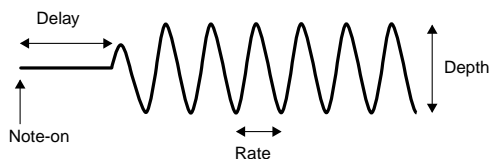

Filter

By modifying the filter settings, you can control the timbre (tone) of the sound. The type of filters in this unit are called Low Pass Filters, and allow only frequencies lower than a specified frequency to pass. This frequency is called the Cutoff Frequency. By modifying the setting of the Cutoff Frequency you can make the sound brighter or darker. The Cutoff Frequency can change over time, controlled by the “envelope”. By adjusting the filter and envelope settings, you can create sounds that have movement and expression.

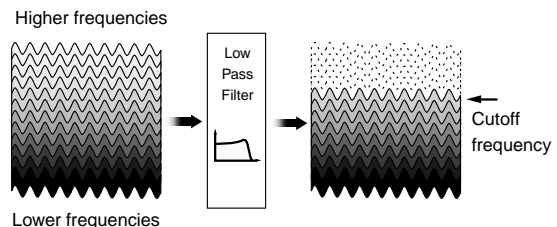

○ Cutoff Freq (Cutoff Frequency): -64 — +63

Positive settings of Cutoff Freq will raise the cutoff frequency. Negative settings will lower the cutoff frequency. As you set this value higher in the positive direction, more overtones will be allowed to pass, and the sound will become harder (brighter). The further this value is set in the negative direction, the fewer overtones will be allowed to pass, and the sound will become softer (darker).

* For some sounds, positive (+) settings of Cutoff Freq will cause no noticeable change in the sound.

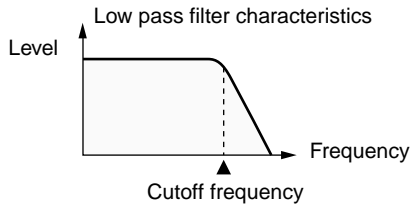

○ Resonance: -64 — +63

When the Resonance value is increased, the overtones in the area of the cutoff frequency will be emphasized, creating a sound with a strong character.

* For some sounds, negative (-) settings of Resonance will cause no noticeable change in the sound.

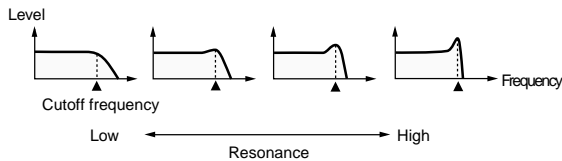

Envelope

The volume of an instrument changes with time, from the moment the note begins to sound to when it disappears. This change can be indicated on a graph as shown in the following diagram. This shape is unique to each instrument, and is an important element in how we distinguish sounds we hear. This shape is called the "envelope." The envelopes of musical instrument sounds can change depending on how the instrument is played. For example if a trumpet is played sharply and strongly, the attack will be quick and the sound will be sharp. But if a trumpet is played lightly and softly, the attack will be softer. In order to adjust the attack of a sound, we can modify the Attack Time of the envelope. By modifying the values of the envelope we can simulate the characteristics of many different instruments.

The envelope shape that we create in this way will also affect the way in which the cutoff frequency changes. If the cutoff frequency had been lowered, it will rise as the envelope rises, and will fall as the envelope falls.

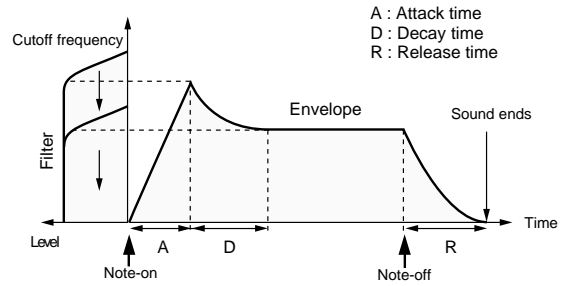

○ Attack Time: -64 — +63

This parameter adjusts the sharpness of the beginning of the sound.

○ Decay Time: -64 — +63

This parameter adjusts the time over which the sound will fall from the highest point of the attack down to the sustain level (Fig.1).

* Some sounds have a sustain level of 0 (Fig.2). Piano and guitar sounds are in this category.

○ Release Time: -64 — +63

This parameter adjusts the time over which the sound will decay after the note is released until it is no longer heard. The cutoff frequency will also fall according to this.

* For some sound, modifying the various Time settings of the envelope will cause no noticeable change in the sound.

Fig.1

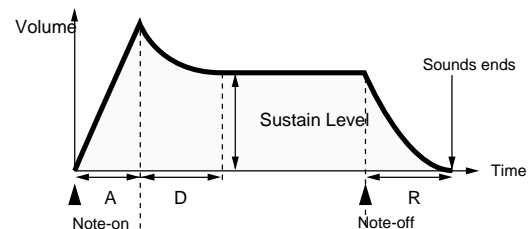
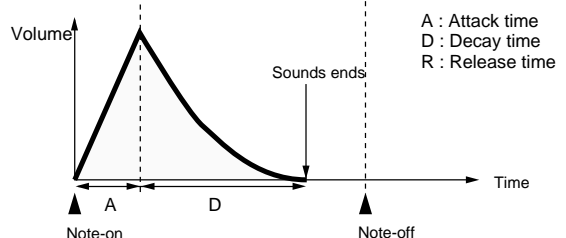

Fig.2



■ Setting parameters common to all Parts

Here's how to make settings for parameters that are common to all Parts.
This procedure allows you to set the following parameters.

LEVEL [l] [r]	: set the volume of all Parts
PAN [l] [r]	: set the pan of all Parts
KEY SHIFT [l] [r]	: transpose all Parts
[MUTE]	: mute all Parts (All Mute)
[SC-55 MAP]	: Set all Parts to the SC-55 map.
[SC-88 MAP]	: Set all Parts to the same sound map structure as the SC-88.

● Procedure

- 1. Make sure that the [ALL] indicator is lit.**
If it is dark, press the [ALL] button to turn it on.

** If you wish to make settings independently for each Part, press the [ALL] button to turn off the indicator, and use the following procedure. (p.25)*
- 2. Use the front panel parameter buttons to make settings.**
- 3. With the LEVEL, PAN and KEY SHIFT buttons, you can simultaneously press both [l] [r] buttons to graphically display the current setting on the screen. If you simultaneously press them once again, the previous screen will reappear.**

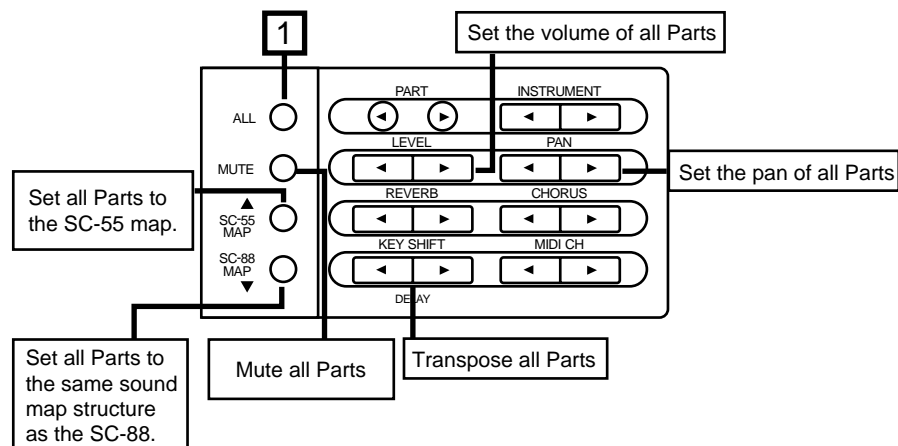

● How each parameter works

* The settings made here apply to all Parts (when the [ALL] indicator is lit). If you wish to make settings independently for each Part, use the procedure of p.25.

○ LEVEL (Master level): 0 — 127

This parameter adjusts the volume of all the Parts. As the displayed value increases, the volume will increase. The basic volume level of this entire unit is adjusted by the Volume knob. If the volume knob is at minimum position, there will be no sound even if you increase this parameter.

○ PAN (Master Pan): L63 — 0 — R63

This parameter sets the Pan (stereo position) for all the Parts. As the displayed L value increases the sound will move further left, and as the R value increases the sound will move further right.

* For some instruments, a bit of sound may be heard from the opposite speaker even if Pan has been set fully left or right.

* If you are listening to this unit in mono, Pan settings will have no effect.

○ KEY SHIFT (Master Key Shift): -24 — ± 0 — +24 semitone steps, 2 octaves

Key Shift adjusts the pitch of the sound in semitone steps. For example if you were playing back song data from a sequencer, you could use the Key Shift parameter to change the key of the song without changing the sequencer settings. Or, if you are singing along with sequence data, you can adjust Key Shift to move the song to the key most comfortable for your voice. As the displayed value rises (falls) one step, the pitch will rise (fall) one semitone. This means that 12 steps equal one octave.

* Even if you adjust Key Shift for all Parts, the pitch of the Drum Part will not be affected.

○ MUTE (All Mute): On/Off

If you press the [MUTE] button to turn the indicator on, All Mute will be on, and the sound of all Parts will be muted.

* Mute can also be set independently for each Part (p.25).

* When All Mute is turned on, each of the lowest dots in the bar display will be turned off.

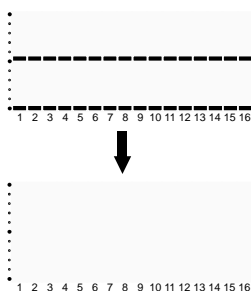

○ SC-55 MAP (ALL SC-55 MAP): On/Off

If you press the [SC-55 MAP] button to make the indicator light, the sounds of all Parts will be set to the same sounds as the SC-55 map.

The [SC-55 MAP] button provides one-touch preparation for playing back SC-55/55mkII performance data.

* It is also possible to turn the SC-55 map on/off for individual Parts (p.25).

* All the sounds for all Parts can be arranged so they use the Native map by holding down [SELECT] while you press [SC-55 MAP] (when the [ALL] indicator is lit). At this time, [SC-55 MAP] indicator blinks.

○ SC-88 MAP (ALL SC-88 MAP): On/Off

If you press the [SC-88 MAP] button to make the indicator light, all Parts will have the same sound map structure as the SC-88.

Parts for which the SC-55 MAP is selected will be played using the sounds of the SC-55 map.

* It is also possible to turn the SC-88 map on/off for individual Parts (p.25)

* When the [ALL] indicator is lit, you can hold down the [SELECT] button and press the [SC-88MAP] button to set all Parts to the SC-88 map. At this time, the [SC-88MAP] indicator will blink.

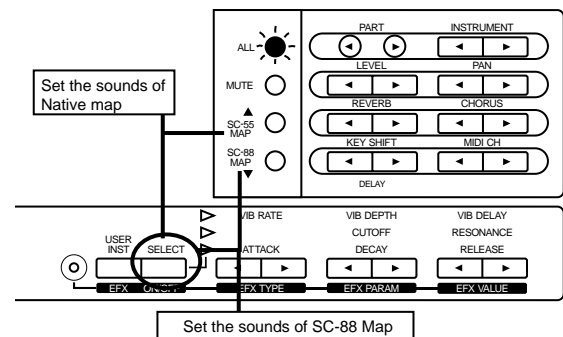

■ System parameter settings

This section explains how to make settings for parameters that affect this entire unit. These parameters are called System parameters. System parameters are as follows.

Prevw Note	(Preview Note Name)
Prevw Velo	(Preview Velocity)
Display	(Display Types)
Peak Hold	(Peak Hold)
LCD Contrast	(LCD Contrast)
Backup	(Backup Switch)
IN B Sel.	(IN B Select)
OUT/THRU	(OUT/THRU Select)
In Mode	(Input Mode)
Rx Sys. Mode	(System Mode Set receive switch)
Sys.OUT Mode	(System Output Mode)
Assign Lock	(Output Assign Lock)
P.Load Init	(Patch Load Initialize switch)

● Procedure

1. Simultaneously press [u] and [d].
2. Press either [u] or [d] to select the parameter you wish to set.

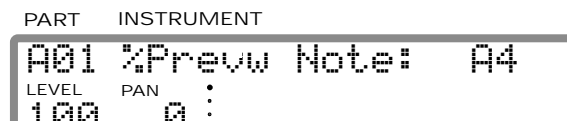

* "%" indicates a parameter that affects this entire unit (a System parameter).

3. Use the INSTRUMENT [l] [r] buttons to set the value.
4. When you finish making settings, simultaneously press the [u] and [d] buttons to exit the procedure.

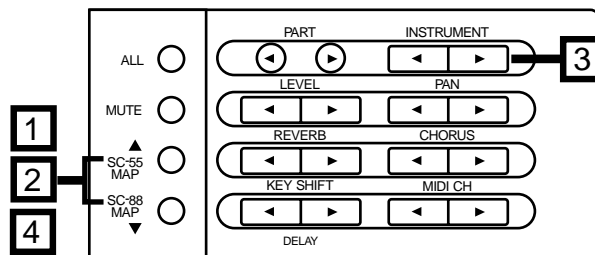

● How each System parameter works

○ Prew Note (Preview Note Name): C-1 — G9

When you press the PREVIEW knob, the instrument shown in the display will sound. The Prew Note parameter determines the note that will be sounded at this time. The A note in the center of the keyboard is A4.

* If you have set Key Shift, the pitch will be shifted (p.25, 34).

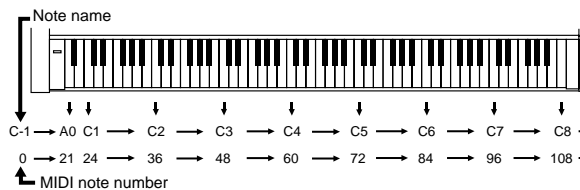
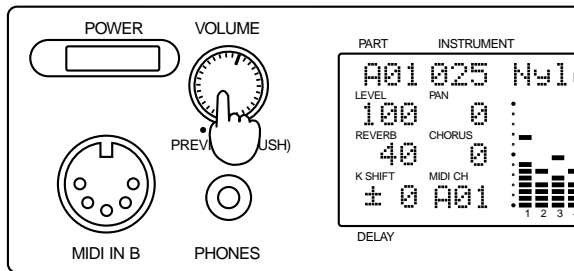

○ Prew Velo (Preview Velocity): 0 — 127

This sets the velocity of the note that sounds when you press the PREVIEW knob. Normally, higher velocities result in louder sound. (p.28 Velocity Sensitivity, etc.)

○ Display (Display Type): Type1 — Type8

This parameter allows you to select one of the following 8 types of volume level display.

* In Double Module mode (p.116), the Type 1 — 4 display and Type 5 — 8 display will be exchanged.



Type 1 : Bar display (factory preset)

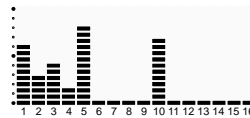

Type 2 : Single segment display

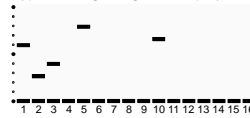

Type 3 : Top to bottom bar display

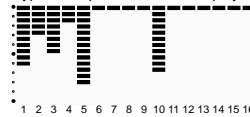

Type 4 : Top to bottom single segment display

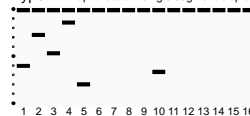

Type 5 : Reverse 1



Type 6 : Reverse 2



Type 7 : Reverse 3

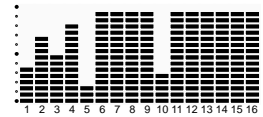

Type 8 : Reverse 4

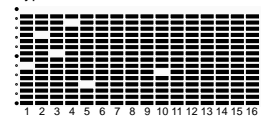

○ Peak Hold: Off/Type1 — Type3



In this unit display, the highest dot in the bar level display will be held on for a short time after the volume falls below it. You can select one of the following four ways in which this Peak Hold function will work.

For Type 1 and Type 3, the dots of the peak level indicator will move downward if the Display parameter explained above is set to Type 3, 4, 7 or 8.

- Off** : The peak level will not be held
- Type1** : After holding the peak level, the peak level dot will move downward
- Type2** : After holding the peak level, the peak level dot will disappear
- Type3** : After holding the peak level, the peak level dot will move upward

○ **LCD Contrast: 1 — 16**

Depending on the angle at which this unit is placed, the display can sometimes be difficult to read. If so, adjust the contrast of the display. Higher values will make the characters darker.



○ **Backup (Backup Switch): On/Off**

When the power is turned off, this unit preserves (backs up) the settings which were made, and when the power is turned on again, these settings will reappear in the display. If the Backup Switch is turned off, the data will not be preserved.

** Even if the Backup Switch is off, the System parameter settings (p.36) will be preserved.*

○ **IN B Sel. (IN B Select): Front/Rear**

This setting determines which of the two MIDI IN B connectors will be used. (p.135)

** After the setting of this switch is changed, the power must be turned on once again for the new setting to take effect.*

○ **OUT/THRU (MIDI OUT/THRU Select): OUT/THRU**

This setting determines whether the rear panel MIDI OUT/THRU connector will function as OUT or as THRU. (p.136)

** After the setting of this switch is changed, the power must be turned on once again for the new setting to take effect.*

○ **In Mode (Input modes): Standard, X-connect, Merge → A, Merge → B, A only**

This setting determines how data received at MIDI IN A and B will be passed on to the Part Groups. (p.137)

** After the setting of this switch is changed, the power must be turned on once again for the new setting to take effect.*

○ **Rx Sys. Mode (System Mode Set Receive Switch): On/Off**

The selection of Single Module Mode or Double Module Mode (p.116) is called the System Mode. The Rx Sys. Mode setting is the receive switch for MIDI messages (System Mode Set p.194) that select the System Mode. If Rx Sys. Mode is turned Off, the mode will not change even if System Mode Set messages are received. If Rx Sys. Mode is turned On, the mode will change. (p.137)

○ **Sys.OUTMode (System Output Mode) : Sel/Fix**

This determines whether the OUT Asgn (Output Assign) setting (p.29) will be valid or not.

Sel :

The sound of each Part will be output as specified by the OUT Asgn settings.

Fix :

The output of each Part will be fixed as follows, regardless of the OUT Asgn settings.

For Single Module Mode:

Both Part Group A and B will be output in stereo with the effect sound from the Output 1 jacks.



For Double Module Mode:

The Parts of group A will be output in stereo with the effect sound from the Output 1 jacks, and the Parts of group B similarly from the Output 2 jacks.

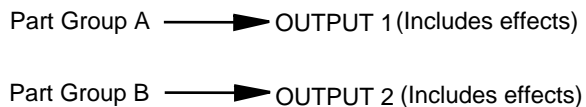

In this case only, the Output 2 jacks will output sound that includes the effect sound.

** The headphone jack will output the sound that is sent to Output 1. This means that the sound of the Parts assigned to Output 2 will not be heard in the headphones.*

** At the factory settings, this parameter is set to Sel.*

○ **Assign Lock (Output Assign Lock): On/Off**

The setting of OUT Asgn (Output Assign) (p.29) will return to the factory settings when GS Reset or GM System On are received. However if Assign Lock is turned On, these settings will not change.

○ **P.Load Init (Patch Load Initialize switch): On/Off**

This specifies whether or not the settings of Parts A03 — B16 will be initialized when a Patch (p.39) is loaded. With a setting of On, the settings of Part A03 and following will be initialized. With a setting of Off, the settings of Part A03 and following will not be initialized. The factory setting is On.

** In Double Module mode, the settings of Part group B will not be initialized.*

■ Using Patches

On this unit, the instrument and effect parameters are collectively referred to as a Patch. This unit provides 128 Preset Patches in which these parameters are already set to ideal settings. (p.186)

Patch numbers 001 — 128: Preset Patches

The Preset Patches contain high-quality sounds together with optimal settings for other parameters such as effects, making this unit immediately useful as an expansion sound module for your keyboard, etc.

Patches contain parameter settings for Part A01 and Part A02 (see following diagram). The initialized values are set for the other Parts.

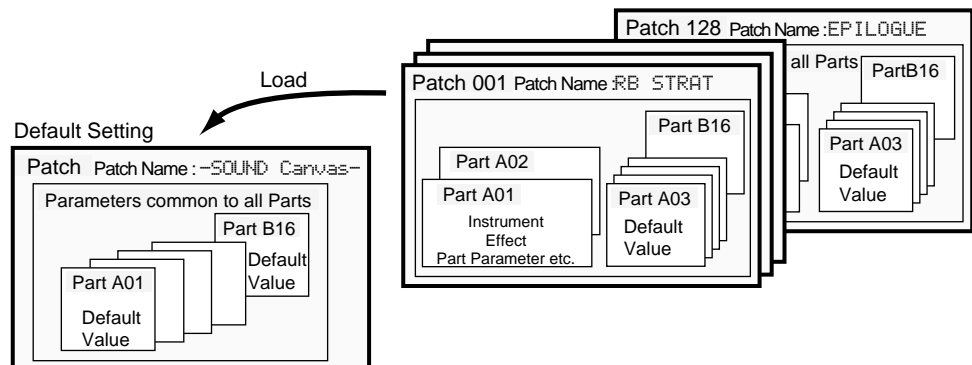

Patches contain all the Patch parameters (p.194). Of these, the main parameters which can be set from the front panel are the following.

- Parameters common to all Parts (p.34)
- System Effects (p.48)
- Insertion Effects (p.56)
- Part parameters for Parts A01 and A02 (p.25, 26, 31)

In Double Module mode, you can select Patches only for the Part Group A, and the parameters will be fixed for Part A01 and Part A02. By playing song data on the Part Group B while you play the Part Group A Patches from a keyboard etc., you can enjoy solo playing while adding unique effects.

Some sequencer software is unable to transmit data from the computer connector to play the Part Group B. In this case, set the In Mode to "Xconnect" so that the Part Group B will be played (p.137).

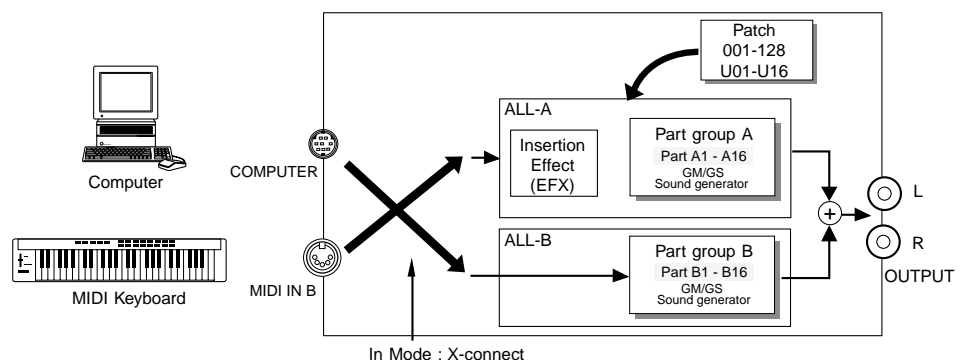

* If you select a Patch in Double Module mode, the equalizer and delay settings will be ignored. Also, Patches cannot be selected for the Part Group B.

● Loading a Patch

1. Press the [ALL] button to make the button indicator light.
2. Use INSTRUMENT [l] [r] to select the Patch that you wish to load.

The Patch name will appear, and the [ALL] button and [MUTE] button will blink.

```

PART  INSTRUMENT
ALL  001  RB  START
LEVEL PAN  :
100  0  :
```

3. Press the [ALL] button to load the Patch.

To cancel without loading, press the [MUTE] button.

```

PART  INSTRUMENT
ALL  001  RB  START
LEVEL PAN  :
100  0  :
```

* It takes awhile until the sound can be heard after you change the Patch.

* Be aware that with the factory settings, the settings of Part A03 and following will be initialized when you load a Patch. If you do not want the settings of Part A03 and following to be initialized when a Patch is loaded, turn "P. Load Init" Off (p.38). Also, in Double Module mode, the settings of Part group B will not be initialized.

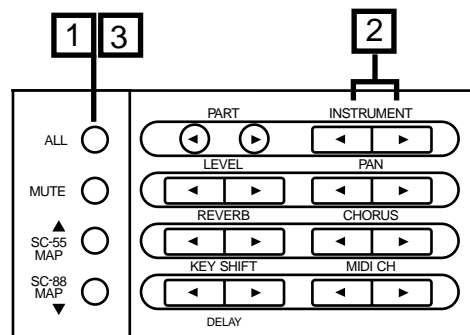

● Using MIDI messages to select Patches

Normally when a MIDI program change message is received, the Instrument of a Part will change. However if you set the MIDI channel for the Patch, the Patch will change when a program change message is received (p.131).

With the Patch MIDI CH settings of "A--" or "B--", incoming program changes will select the Instrument of the corresponding Part.

* With the factory settings, the Patch MIDI CH is set to A--.

1. Press the [ALL] button to make the button indicator light.
2. Use MIDI CH [I] [r] to set the MIDI channel.

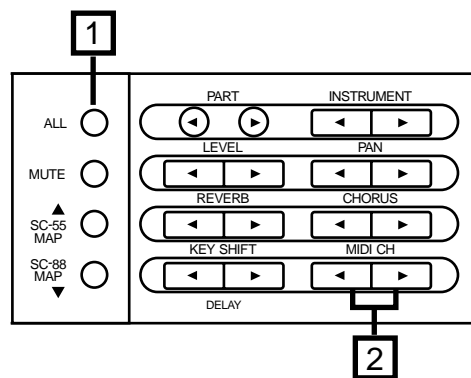
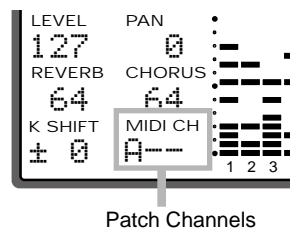

For example, suppose that the MIDI channels of the Patch and Part were set to the same value. In this case, an incoming program change on channel 1 [COH 01H] will select Patch 02 MILD OD, but the Instrument of Part A01 the instrument (TC Front Pick) specified for the Patch will be used.

Patch MIDI CH: "A01"

Part A01 MIDI CH: "A01"

If you want program changes to once again select the Instrument of Part A01, set the Patch MIDI CH to "A--".

* It takes awhile until the sound can be heard after you change the Patch.

■ Creating a Drum Set (Drum Edit)

A Drum Part has assigned to it a group of various percussion instrument sounds which are called a Drum Set. Unlike a Normal Part, a Drum Part sounds a different instrument for each note number. Since a Drum Part needs to simultaneously produce a wide variety of sounds such as bass drum, snare, tom and cymbal, this is very convenient. A collection of such sounds each assigned to their own note number is called a Drum Set. Each sound within a Drum Set is called an Drum Instrument. (Drum Set list p.163)

On this unit, you can modify various drum instrument parameters to get the drum sounds most suitable for your musical needs. A “parameter” is something that affects the sound. The process of modifying parameter values is called “editing.”

For each instrument (Drum Instrument) of the currently selected Drum Set, you can modify the values for the following parameters. These parameter values are set independently for each Drum Instrument assigned to a note number.

Volume, Pan (stereo position), Pitch, Reverb send level, Chorus send level, Delay send level, Assign group.

* Drum Sets you create can be stored in internal memory. (p.102)

* Settings between the Normal Part and the Drum Part are made in Part mode. (p.27)

● Drum editing procedure

1. Make sure that the [ALL] indicator is dark.

If it is lit, press the [ALL] button to turn it off.

2. Use the PART [I] [r] buttons to select the Drum Part.

Drum Parts are indicated by an “*” mark at the left of the sound name.

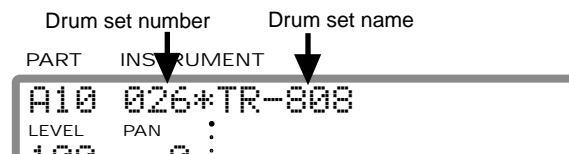

3. Use the INSTRUMENT [I] [r] buttons to select a Drum Set.

If you press the [SC-55 MAP] button to make the indicator light, you can select the same Drum Sets as in the SC-55/55mkII. SC-55/55mkII drum sets are indicated by a “!” mark at the left of the Drum Set name. If you press the [SC-88 MAP] button to make the indicator light, you can select the same Drum Sets as in the SC-88. SC-88 drum sets are indicated by a “?” mark at the left of the Drum Set name. Your editing will apply to the Drum Set you select here.

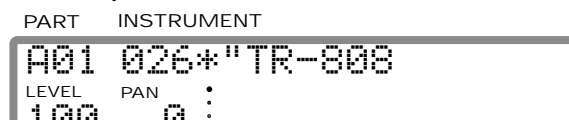

4. Simultaneously press both the [SELECT] and EFX TYPE [I] button.

The display will show the Part Group (p.23), the Part Mode (p.27), Drum Set number, note name, and Drum Instrument name.

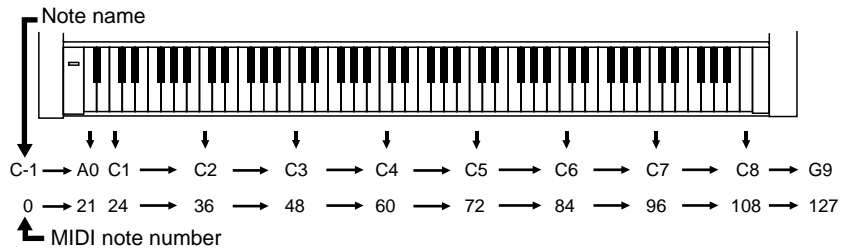
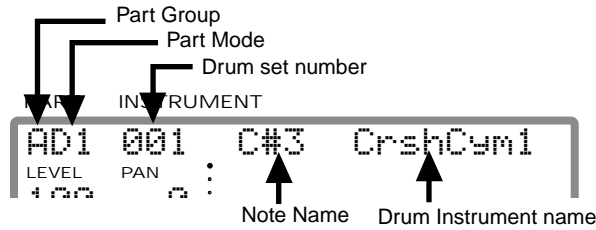

* The Note name is the name of each note (key) on the keyboard, and corresponds to the MIDI Note Number. The Drum instrument is assigned to note number.

5. Use the INSTRUMENT [I] [r] buttons select the Drum Instrument you wish to edit.

Here you can also select Drum Sets. Since in both cases you use the INSTRUMENT [I] [r] buttons to specify the number. You will need to switch between Drum Set select mode and Drum Instrument select mode, simultaneously press both the INSTRUMENT [I] [r] buttons. When you are selecting Drum Sets, the Drum Set number will blink.

* Be aware that if you select a different Drum Set, the parameter Value will be initialized.

6. Use the front panel parameter buttons to modify the parameter values.

The values you set will appear in the appropriate location (field) of the display.

- LEVEL [I] [r] : set the volume of each instrument
- PAN [I] [r] : set the pan of each instrument
- REVERB [I] [r] : set the reverb send level of each instrument
- CHORUS [I] [r] : set the chorus send level of each instrument
- EFX TYPE [I] [r] : set the delay send level of each instrument
- KEY SHIFT [I] [r] : pitch coarse (adjust the pitch of each instrument in semitone steps)
- MIDI CH [I] [r] : assign group (p.44)

7. To return to the previous display, simultaneously press both the [SELECT] and EFX TYPE [I] button once again.

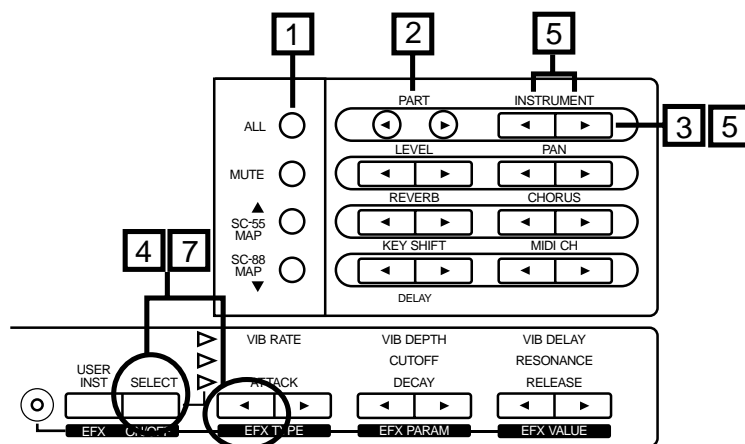

● Using Chorus and Delay

In the case of a Drum Instrument, it is not possible to simultaneously use both chorus and delay. Chorus will not be applied to a Drum Instrument for which “d” and “D” is displayed in the CHORUS column (Fig.2). In this case, you can apply chorus by using the CHORUS [I] [r] buttons to set the chorus send level.

Delay will not be applied to a Drum Instrument for which a number is displayed in the CHORUS column (Fig.1). In this case, you can apply delay by press the EFX TYPE [I] [r] buttons to set the delay send level. In other words, in the case of chorus and delay, only the one you specify last will be valid.

Drum edit screen

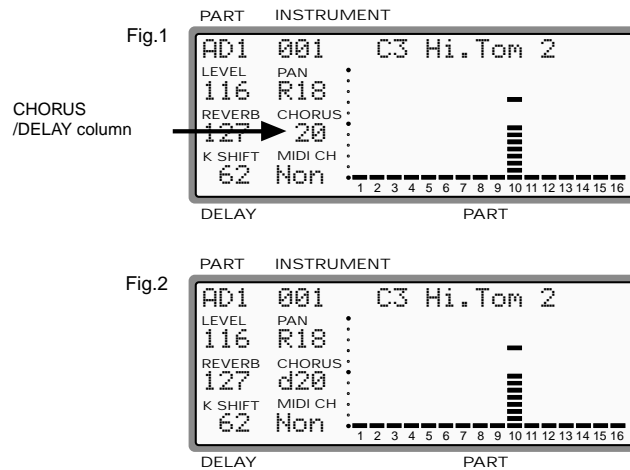

* The Delay setting will be displayed as “d00” — “d99” for values of 0 to 99, and as “D00” — “D27” for values of 100 to 127.

● About the Assign Group

Each instrument can be given a number, and instruments with the identical number are treated as an Assign Group. No two instruments of the same Assign Group will sound together. If while one instrument is sounding, a MIDI message is received to play another instrument in the same Assign Group, the first instrument will be turned off first. This is a useful way to prevent two instruments from sounding simultaneously that would not normally do so. For example since it is obviously impossible for a hi-hat to simultaneously produce both an open hi-hat sound and a closed hi-hat sound, these two sounds could be set to the same Assign Group (the same number) so that they would not sound together.

Numbers from Non, 1 to 127 can be selected, but instruments for which Non is selected will not be turned off by other instruments. In other words, instruments with a setting of Non will not be treated as an Assign Group.

* Be aware that if you select a different Drum Set, the parameter values will be initialized.

Chapter 3

System Effects

■ How the effect section of the unit is organized

The effects of this unit can be categorized into System effects (p.48) and Insertion effects (p.56).

System effects include 8 types of reverb and chorus, 10 types of delay, and 2-band equalizer. Insertion effects include a variety of 64 different effect types.

Of the System effects, the reverb/chorus/delay effects take part of the sound from each Part to create a new effected sound (reverberance, etc.), and then add this to the original sound.

For these effects, you can specify the amount of the sound for each Part sent to the effect unit (Send Level). Higher settings will increase the level of the signal that is sent to the effect unit, causing the effect sound that is produced to be louder. The result is that the effect becomes deeper.

For the equalizer of System effects, on the other hand, you can select whether the sound of the Part will pass through the equalizer or not; i.e., make an on/off setting to modify the sound.

Insertion effects is the type of effect that modifies the sound itself, and is able to give it a completely different character. You can specify for each Part whether or not it will pass through the effect.

Since only one type of Insertion effect can be applied at a time, turning it on for two or more Parts will cause the sound of these Parts to be mixed. If a System effect is applied to a Part for which the Insertion effect is turned on, the Insertion effect Send Level will be used instead of the Send Level of the Part itself.

Also, the type of effects that are available here will depend on the System mode setting.

In Single Module mode (mode 1), each will have one set of effects.

In Double Module mode (mode 2), equalizer and delay are unavailable, but there are two sets each for Reverb and Chorus settings, and these can be used simultaneously.

This is especially valuable when you wish to have different effect types or settings for each Part. Also, the Insertion effect can be used only for the Part group A. This is every effective when you wish to apply a special effect to the solo part that you play.

* For details on Single Module mode and Double Module mode, refer to p.116.

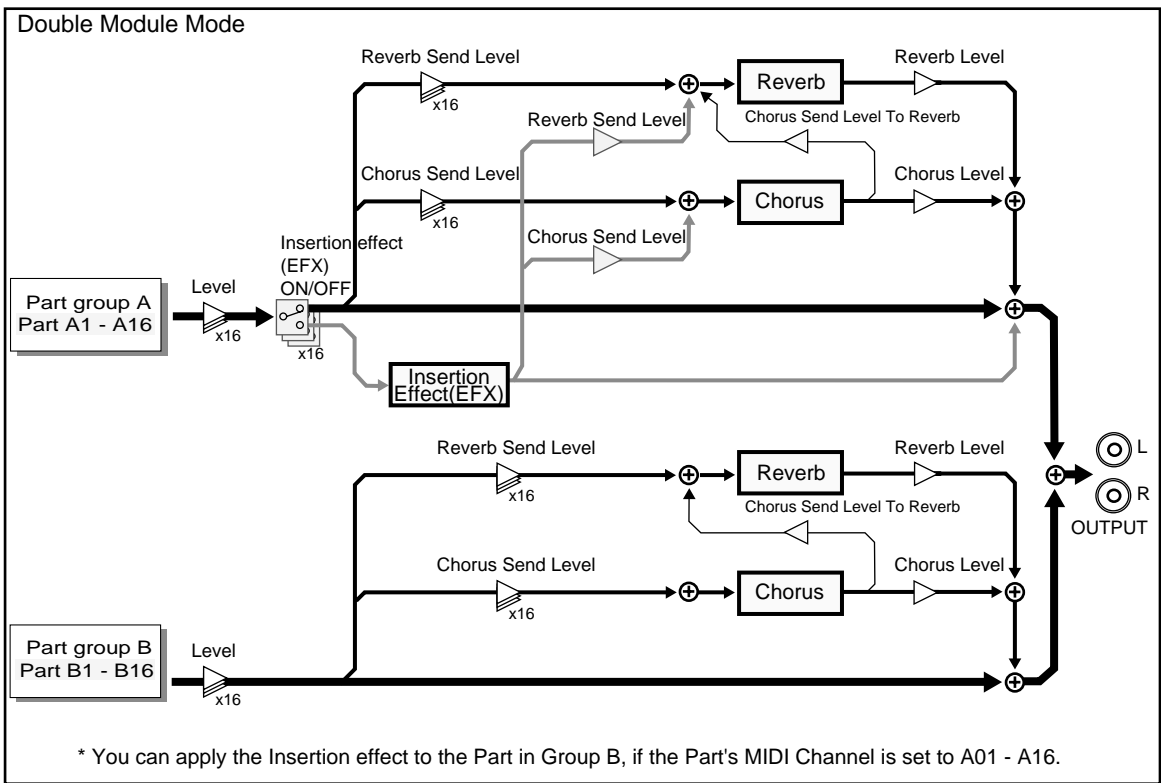
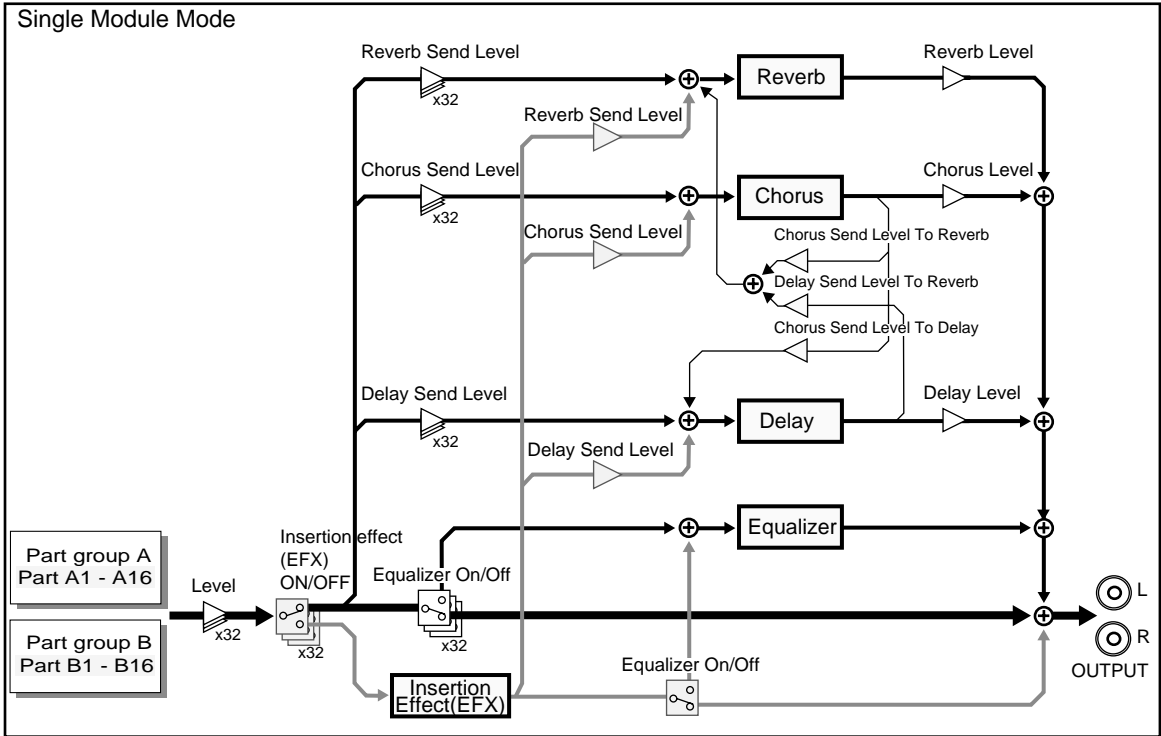

■ System Effect settings

The System effects of this unit include 8 types of reverb and chorus, and 10 types of delay. In addition, for each of these effects you can specify parameter values such as character, depth, rate and time. Reverb is an effect that adds reverberation to a sound, as you would hear in a concert hall. Chorus broadens the spatial image of the sound, adding depth and richness. Delay creates echoes. It is also possible to give depth and width to a sound by adding a short delay to the original sound. For these effects, you can set the overall level for all Parts and also individual levels for each Part.

This unit has a two-band equalizer (high range, low range). An equalizer lets you boost or cut specified frequency ranges of a sound to adjust the tone. For each range, high and low, you can specify the frequency and the amount of boost or cut (gain).

● Equalizer setting procedure

- * The equalizer cannot be used when Double Module Mode (p.116) is selected.
- * The equalizer can be turned on/off for individual Parts. (p.27)

1. Press [ALL] to make the button indicator light.
2. Press [SELECT] to display the equalizer setting.

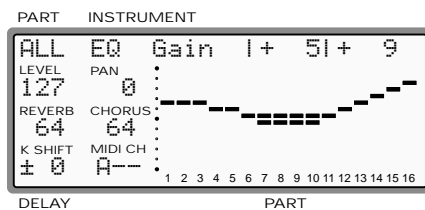

3. Press the EFX TYPE [l] [r] buttons to select gain or frequency setting display.

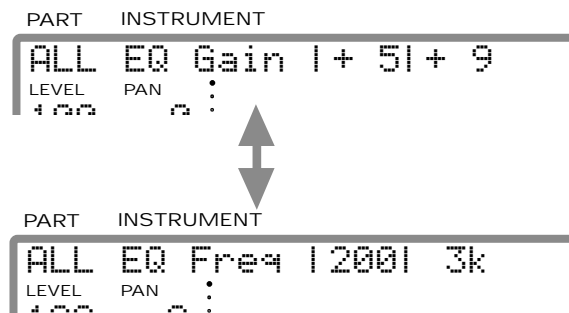

- Use the EFX PARAM [l] [r] buttons to adjust the EQ Gain(Low) or the Low Frequency. Use the EFX VALUE [l] [r] buttons to adjust the EQ Gain(High) or the High Frequency.

* The equalizer settings you make here are common to all Parts. They cannot be set independently for individual Parts.

- When you finish making settings, press [SELECT] once again to end the procedure.

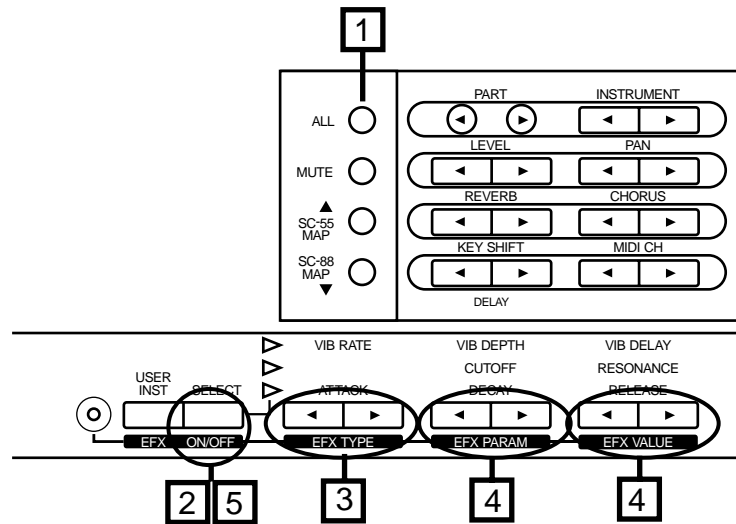

● Equalizer parameter functions

○ **EQ Gain (Low): -12 — 0 — +12dB**

○ **EQ Gain (High): -12 — 0 — +12dB**

Specify the amount of boost or cut (gain) for the high frequency range (high) and the low frequency range (low). Positive (+) settings will boost, and negative (-) settings will cut.

* With a Gain setting of 0, the equalizer will have no effect.

○ **EQ Low Freq (Equalizer Low Frequency): 200/400 Hz**

○ **EQ High Freq (Equalizer High Frequency): 3/6 kHz**

These parameters set the cutoff frequencies of the ranges boosted or cut by the equalizer.

● When you want to adjust the system effect for all Parts

1. Press [ALL] to make the button indicator light.

2. Press the button of the effect you wish to adjust.

REVERB [I][r] : reverb level of all Parts

CHORUS [I][r] : chorus level of all Parts

DELAY [I][r] (while holding down the [SC-88 MAP])
: delay level of all Parts

3. When you perform the following operation, the current parameter value will be displayed graphically.

Simultaneously press both [I][r] buttons of REVERB or CHORUS.

While holding the [SC-88MAP] button, press both [I][r] buttons of DELAY.

Simultaneously press both buttons once again and the previous display will reappear.

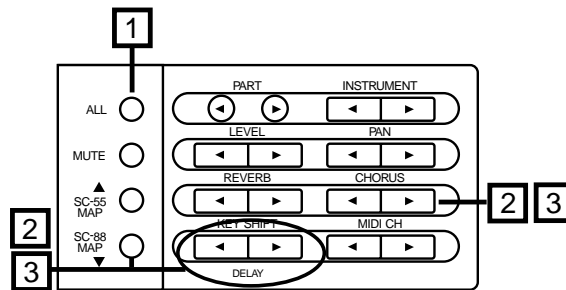

* If the indicator of EFX is dark, you can also use EFX TYPE [I][r] to adjust delay level. Simultaneously press both EFX TYPE [I][r], and the delay parameter values will be displayed graphically.

● When you want to adjust the system effect for each Part

1. Make sure that the [ALL] indicator is dark.

If it is lit, press the [ALL] button to turn it off.

2. Use the PART [I][r] buttons to select the Part you wish to modify.

3. Press the button of the effect you wish to adjust.

REVERB [I][r] : reverb level of each Part

CHORUS [I][r] : chorus level of each Parts

DELAY [I][r] (while holding down the [SC-88 MAP])
: delay level of each Parts

* You can not select the System effect parameters individually for the Part with Insertion effect "on".(p.46)

4. When you perform the following operation, the current parameter value will be displayed graphically.

Simultaneously press both [I][r] buttons of REVERB or CHORUS.

While holding the [SC-88MAP] button, press both [I][r] buttons of DELAY.

Simultaneously press both buttons once again and the previous display will reappear.

* If the indicator of EFX is dark, you can also use EFX TYPE [I][r] to adjust delay level. Simultaneously press both EFX TYPE [I][r], and the delay parameter values will be displayed graphically.

● Setting Reverb/Chorus/Delay parameters

1. Press [ALL] to make the button indicator light.
2. Simultaneously press both the PART [l] [r] buttons.
3. Use [u] [d] to select the parameter you wish to modify.
While holding the [SELECT] button, press[u][d] to skip parameters.

```

PART  INSTRUMENT
ALL  >Reverb:  Hall12
LEVEL PAN  :
100  0  :
```

4. Use INSTRUMENT [l] [r] to set the value.

```

PART  INSTRUMENT
ALL  >Reverb:  Plate
LEVEL PAN  :
100  0  :
```

5. When you finish making settings, simultaneously press both PART [l] [r] buttons to end the procedure.

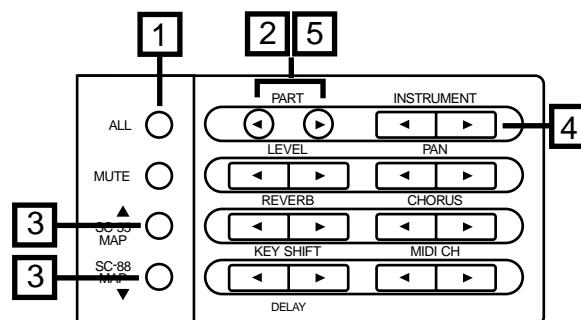

* Delay cannot be used when Double Module Mode (p.116) is selected.

● Reverb parameter function

○ Reverb (Reverb Type)

You can choose from 8 types of reverb.

Room1 Room2 Room3

These reverbs simulate the reverberation of a room. They provide a well-defined spacious reverberation.

Hall1 Hall2

These reverbs simulate the reverberation of a concert hall. They provide a deeper reverberation than the Room reverbs.

Plate

This simulates a plate reverb (a studio device using a metal plate).

Delay

This is a conventional delay that produces echo effects.

Panning Delay

This is a special delay in which the delayed sounds move left and right. It is effective when you are listening in stereo.

When you change the Reverb Type, the following parameter values will automatically change. This is so that the parameter values will have the settings most appropriate for the selected Reverb Type. You can select these parameters (p.51) and modify the values to adjust the effect to your taste.

○ Rev Charac. (Reverb Character) 0 — 7

This parameter selects only the type of reverb. 0 — 5 are reverb effects, and 6 and 7 are delay effects.

○ Rev Pre-LPF (Reverb Pre Low Pass Filter) 0 — 7

A low pass filter can be applied to the sound coming into the reverb to cut the high frequency range. Higher values will cut more of the high frequencies, resulting in a more mellow reverberation.

○ Rev Level (Reverb Level) 0 — 127

This parameter sets the amount of the reverberant sound. Higher values result in louder reverberation.

○ Rev Time (Reverb Time) 0 — 127

This parameter sets the time over which the reverberation will continue. Higher values result in longer reverberation.

○ Rev Delay Fb (Reverb Delay Feedback) 0 — 127

This parameter is used when the Reverb Charac. is set to 6 or 7, Reverb Type is set to Delay or Panning Delay. It sets the way in which delays repeat. Higher values result in more delay repeats.

○ RevPreDlyT (Reverb Pre-Delay Time) 0ms — 127ms

This parameter sets the delay time until the reverberant sound is heard. Higher values result in a longer pre-delay time, simulating a larger reverberant space.

** Reverb Pre-Delay Time cannot be used when Double Module Mode (p.116) is selected.*

About Reverb Type

When you change the Reverb Type, the above-listed six reverb parameters (including Reverb Character) will be automatically adjusted to the optimal values. Rather than individually adjusting each reverb parameter, it is easier to first set the Reverb Type (listed in the MIDI implementation as "REVERB MACRO" → p.194), and then modify only those parameters that you wish to modify. In particular when using MIDI exclusive messages, this method of making settings will minimize the amount of data. Chorus Type (CHORUS MACRO) and Delay Type (DELAY MACRO) can be used in the same way.

● Chorus parameter function

○ Chorus (Chorus Type)

You can choose from 8 types of chorus.

Chorus1 Chorus2 Chorus3 Chorus4

These are conventional chorus effects that add spaciousness and depth to the sound.

Feedback Chorus

This is a chorus with a flanger-like effect and a soft sound.

Flanger

This is an effect sounding somewhat like a jet airplane taking off and landing.

Short Delay

This is a delay with a short delay time.

Short Delay (FB)

This is a short delay with many repeats.

When you change the Chorus Type, the following parameter values will automatically change. This is so that the parameter values will have the settings most appropriate for the selected Chorus Type. You can select these parameters(p.51) and modify the values to adjust the effect to your taste.

○ Cho Pre-LPF (Chorus Pre Low Pass Filter) 0 — 7

A low pass filter can be applied to the sound coming into the chorus to cut the high frequency range. Higher values will cut more of the high frequencies, resulting in a more mellow chorus sound.

○ Cho Level (Chorus Level) 0 — 127

This parameter sets the amount of the chorus sound. Higher values will cause the chorus sound to be louder.

○ ChoFeedback (Chorus Feedback Level) 0 — 127

This parameter sets the level at which the chorus sound is returned (fed back) into the chorus. By using feedback, a denser chorus sound can be created. Higher values result in a greater feedback level.

○ Cho Delay (Chorus Delay Time) 0 — 127

This parameter sets the delay time of the chorus effect. Higher values will cause greater deviation in pitch of the chorus sound.

○ Cho Rate (Chorus Rate) 0 — 127

This parameter sets the speed (frequency) at which the chorus sound is modulated. Higher values result in faster modulation.

○ Cho Depth (Chorus Depth) 0 — 127

This parameter sets the depth at which the chorus sound is modulated. Higher values result in deeper modulation.

○ Cho → Rev (Chorus Send Level To Reverb) 0 — 127

This parameter sets the amount of chorus sound that will be sent to the reverb. Higher values result in more sound being sent.

○ Cho → Dly (Chorus Send Level To Delay) 0 — 127

This parameter sets the amount of chorus sound that will be sent to the delay. Higher values result in more sound being sent.

* *Chorus Send Level To Delay cannot be used when Double Module Mode (p.116) is selected.*

● Delay parameter function

* *Delay cannot be used when Double Module Mode (p.116) is selected.*

○ Delay (Delay Type)

You can choose from 10 types of delay.

Delay1 Delay2 Delay3

These are conventional delays. 1, 2 and 3 have progressively longer delay times.

Delay4

This is a delay with a rather short delay time.

Pan Delay1 Pan Delay2 Pan Delay3

The delay sound moves between left and right. This is effective when listening in stereo. 1, 2 and 3 have progressively longer delay times.

Pan Delay4

This is a rather short delay with the delayed sound moving between left and right. It is effective when listening in stereo.

Delay to Reverb

Reverb is added to the delay sound which moves between left and right. It is effective when listening in stereo.

Panning Repeat

The delay sound moves between left and right, but the pan positioning is different than the effects listed above. It is effective when listening in stereo.

When you change the Delay Type, the following parameter values will automatically change. This is so that the parameter values will have the settings most appropriate for the selected Delay Type. You can select these parameters (p.51) and modify the values to adjust the effect to your taste.

○ Dly Pre-LPF (Delay Pre Low Pass Filter) 0 — 7

A low pass filter can be applied to the sound coming into the delay to cut the high frequency range. Higher values will cut more of the high frequencies, resulting in a more mellow delay sound.

○ Dly Time C (Delay Time Center) 0.1ms — 1.0s

The delay effect of this unit allows you to set three delay times; center, left and right (when listening in stereo). Delay Time Center sets the delay time of the delay located at the center.

○ DlyTRatioL (Delay Time Ratio Left) 4% — 500%

This parameter sets the delay time of the delay located at the left as a percentage of the Delay Time Center. (up to a max. of 1.0s)

○ DlyTRatioR (Delay Time Ratio Right) 4% — 500%

This parameter sets the delay time of the delay located at the right as a percentage of the Delay Time Center. (up to a max. of 1.0s)

○ Dly Level C (Delay Level Center) 0 — 127

This parameter sets the volume of the central delay. Higher values result in a louder center delay.

○ Dly Level L (Delay Level Left) 0 — 127

This parameter sets the volume of the left delay. Higher values result in a louder left delay.

○ Dly Level R (Delay Level Right) 0 — 127

This parameter sets the volume of the right delay. Higher values result in a louder right delay.

○ Dly Level (Delay Level) 0 — 127

This parameter sets the overall volume of the three delays (center, left and right). Higher values result in a louder overall delay.

○ Dly Fback (Delay Feedback) -64 — 0 — +63

This parameter affects the number of times the delay will repeat. With a value of 0, the delay will not repeat. With higher values there will be more repeats. With negative (-) values, the center delay will be fed back with inverted phase. Negative values are effective with short delay times.

○ Dly → Rev (Delay Send Level To Reverb) 0 — 127

This parameter sets the amount of delay sound that is sent to the reverb. Higher values result in more sound being sent.

Chapter 4

Insertion Effects

■ Insertion effect settings

This unit has two types of effects: System effects and Insertion effects. Insertion effects provide 64 effect types. Since appropriate parameters are provided for each effects, you can make fine adjustments to the sound for professional-level control.

* For details on System effects and Insertion effects, and on the effect structure of this unit, refer to p.46.

Insertion effects can be applied independently to an individual Part.

● Making Insertion effect settings

1. Use PART [I][r] to select the Part, and INSTRUMENT [I][r] to select the Instrument to which the effect will be applied.
2. Press the [EFX] button to make the indicator light orange.
3. Press the [ON/OFF] button to make the Effect ON/OFF indicator light, and the Insertion effect will be turned on.
To turn it off, press the [ON/OFF] button again.
4. Use EFX TYPE [I][r] to select the Effect Type.
5. Use EFX PARAM [I][r] to select parameters.
6. Use EFX VALUE [I][r] to set the value of the effect parameter.
7. While the [ALL] indicator is lit, press the [ON/OFF] button to turn off the Effect ON/OFF indicator, and effects will be turned off for all Parts.
8. Press the [EFX] button to end the procedure.
Be aware that when you change the Effect Type, the effect parameters will be initialized. If you wish to save your parameter values, it is convenient to use a User Effect. (p.99)

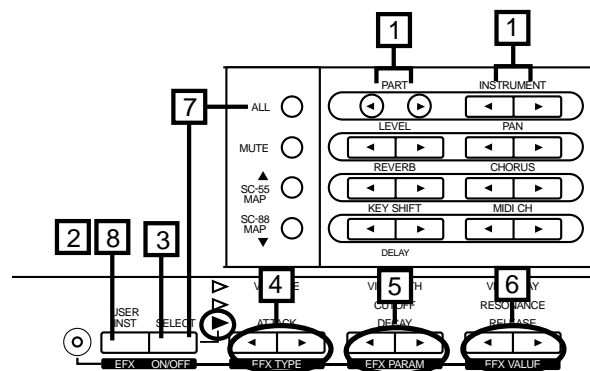

- * It takes awhile until the sound can be heard after you change the Patch.
- * If a monaural insertion effect is turned on, the settings for Part Pan (p. 25) and Master Pan (p. 34) will be ignored. Monaural insertion effects are those such as 2: Spectrum and 35: OD-> Chorus.
In the case of stereo insertion effects, however, the settings for Part Pan (p.25) and Master Pan (p. 34) will be effective when the insertion effect is on. Stereo insertion effects are those that maintain discrete L/R channels all the way to the output stage such as 1: Stereo-EQ and 16: Hexa Chorus.
- * If the Insertion effect is turned on for two or more Parts, the sound of each Part will be mixed. It will not be possible to set reverb / chorus / delay / equalizer independently for these Parts. (p.46)
For example if the Insertion effect is turned on for Part1 and Part2, and you modify the Reverb value for Part1, the Reverb for Part2 wil automatically be modified to the same value.
For Parts for which the Insertion effect is Off, settings can be made independently for each Part.
- * When 00 Thru is selected, the Insertion effect will not be applied.

● Different effect types

Effect types can be broadly grouped into the following categories.

Effects that modify the tone color (filter type) (1 - 4)

Effects that distort the sound (distortion type) (5 - 6)

Effects that modulate the sound (modulation type) (7 - 13)

Effects that affect the level (compressor type) (14 - 15)

Effects that broaden the sound (chorus type) (16 - 20)

Effects that reverberate the sound (delay/reverb type) (21 - 28)

Effects that modify the pitch (pitch shift type) (29 - 30)

Others (31 - 34)

Effects that connect two types of effect in series (series 2) (35 - 46)

Effects that connect three or more types of effect in series (series 3 / series 4 / series 5) (47 - 55)

Effects that connect two types of effect in parallel (parallel 2) (56 - 64)

In the explanations that follow, the hexadecimal values used when making settings via exclusive messages are given at the end of the effect type line. The parameter number is given in decimal form at the end of the Effect Parameter line. Use these values when you use MIDI messages to set parameters. For details on using exclusive messages, refer to p.191.

< Example >

1: Stereo-EQ [01H, 00H]

This means that the value for Address 40H 03H 00H is MSB:01H, LSB:00H.

For example, if you wish to set the effect type to 1: Stereo-EQ, use an exclusive message such as the following:

```
F0 41 10 42 12 40 03 00 01 00 3C F7
                address value
```

Low Freq 200/400 [1]
 "[1]" describes that it's the first parameter.

Parameters with "+" or "#" symbols allow you to modify their value using specified controller, such as pitch bend lever and sliders, or with control change messages. (p.92)

0: Thru [00H, 00H]

No Effect will be applied. When a GM System On or GS Reset messages(p.133) is received, 0:Thru will be selected for Insertion Effect.

○ Effects that modify the tone color (filter type)

1: Stereo-EQ (Stereo equalizer) [01H, 00H]

This is a four-band stereo equalizer (low, mid x 2, high).



Low Freq (Low frequency) 200/400 [1]
 Select the frequency of the low range (200 Hz/400 Hz).

Low Gain -12 - +12 [2]
 Adjust the gain of the low frequency.

Hi Freq (High frequency) 4k/8k [3]
 Select the frequency of the high range (4kHz/8kHz).

Hi Gain -12 - +12 [4]
 Adjust the gain of the high frequency.

M1 Freq (Mid 1 frequency) 200 - 6.3k [5]
 Adjust the frequency of Mid 1 (mid range1).

M1 Q (Mid 1 Q) 0.5/1.0/2.0/4.0/9.0 [6]
 This parameter adjusts the width of the area around the M1 Freq parameter that will be affected by the Gain setting. Higher values of Q will result in a narrower area being affected.

M1 Gain (Mid 1 gain) -12 - +12 [7]
 Adjust the gain for the area specified by the M1 Freq parameter and M1 Q parameter settings.

M2 Freq (Mid 2 frequency) 200 - 6.3k [8]
 Adjust the frequency of Mid 2 (mid range2).

M2 Q (Mid 2 Q) 0.5/1.0/2.0/4.0/9.0 [9]
 This parameter adjusts the width of the area around the M2 Freq parameter that will be affected by the Gain setting. Higher values of Q will result in a narrower area being affected.

M2 Gain (Mid 2 gain) -12 - +12 [10]
 Adjust the gain for the area specified by the M2 Freq parameter and M2 Q parameter settings.

+Level (Output level) 0 - 127 [20]
 Adjust the output level.

2: Spectrum [01H, 01H]

Spectrum is a type of filter which modifies the timbre by boosting or cutting the level at specific frequencies. It is similar to an equalizer, but has 8 frequency points fixed at locations most suitable for adding character to the sound.

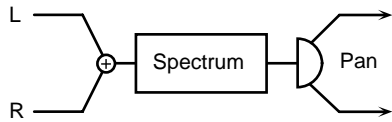

- Band 1 (Band 1 gain) -12 - +12 [1]
Adjust the 250 Hz level.
- Band 2 (Band 2 gain) -12 - +12 [2]
Adjust the 500 Hz level.
- Band 3 (Band 3 gain) -12 - +12 [3]
Adjust the 1000 Hz (1 kHz) level.
- Band 4 (Band 4 gain) -12 - +12 [4]
Adjust the 1250 Hz level.
- Band 5 (Band 5 gain) -12 - +12 [5]
Adjust the 2000 Hz level.
- Band 6 (Band 6 gain) -12 - +12 [6]
Adjust the 3150 Hz level.
- Band 7 (Band 7 gain) -12 - +12 [7]
Adjust the 4000 Hz level.
- Band 8 (Band 8 gain) -12 - +12 [8]
Adjust the 8000 Hz level.
- Width (Band width) 0.5/1.0/2.0/4.0/9.0 [9]
Adjust the width of the frequency bands whose gain is being modified (common to all bands). Higher settings will make the frequency band narrower.
- +Pan (Output pan) L63 - 0 - R63 [19]
Adjust the stereo location of the output sound. L63 is far left, 0 is center, and R63 is far right.
- #Level (Output level) 0 - 127 [20]
Adjust the output level.

3: Enhancer [01H, 02H]

The Enhancer controls the overtone structure of the high frequencies, adding sparkle and tightness to the sound.

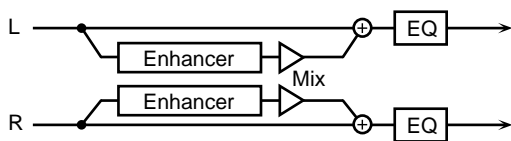

- +Sens (Sensitivity) 0 - 127 [1]
Adjust the sensitivity of the enhancer.
- #Mix (Mix level) 0 - 127 [2]
Adjust the ratio with which the overtones generated by the enhancer are combined with the direct sound.
- Low Gain -12 - +12 [17]
Adjust the gain of the low frequency range.
- Hi Gain -12 - +12 [18]
Adjust the gain of the high frequency range.

Level (Output level) 0 - 127 [20]
Adjust the output level.

4: Humanizer [01H, 03H]

This adds a vowel character to the sound, making it similar to a human voice.

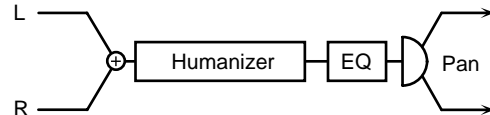

- Drive 0 - 127 [1]
Adjust the depth of distortion.
- Drive Sw Off/On [2]
Turn Drive on/off.
- +Vowel a/i/u/e/o [3]
Select the vowel.
- Accel 0 - 15 [4]
Adjust the time over which the sound will move to the specified Vowel. Smaller values will require more time.
- Low Gain -12 - +12 [17]
Adjust the low frequency gain.
- Hi Gain (High gain) -12 - +12 [18]
Adjust the high frequency gain.
- Pan (Output Pan) L63 - 0 - R63 [19]
Adjust the stereo position of the output sound. L63 is far left, 0 is center, and R63 is far right.
- #Level (Output level) 0 - 127 [20]
Adjust the output volume.

Effects that distort the sound (distortion type)

5: Overdrive [01H, 10H]

This effect creates a soft distortion similar to that produced by tube amplifiers.

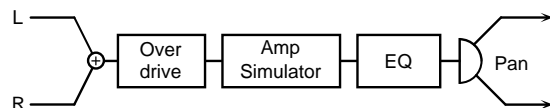

- +Drive 0 - 127 [1]
Adjust the degree of distortion.
- Amp Type (Amp simulator type) Small/BltIn/2-Stk/3-Stk [2]
Select the type of guitar amp.
 - Small** : small amp
 - BltIn** : single-unit type amp
 - 2-Stk** : large double stack amp
 - 3-Stk** : large triple stack amp

Amp Sw (Amp switch)	Off/On [3]
Turn the Amp Type on/off.	
Low Gain	-12 - +12 [17]
Adjust the gain of the low frequency range.	
Hi Gain (High gain)	-12 - +12 [18]
Adjust the gain of the high frequency range.	
#Pan (Output pan)	L63 - 0 - R63 [19]
Adjust the stereo location of the output sound. L63 is far left, 0 is center, and R63 is far right.	
Level (Output level)	0 - 127 [20]
Adjust the output level.	

6: Distortion [01H, 11H]

This effect produces a more intense distortion than Overdrive.

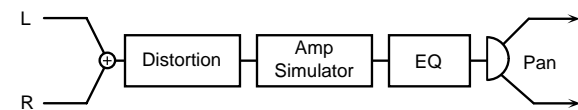

+Drive	0 - 127 [1]
Adjust the degree of distortion.	
Amp Type (Amp simulator type)	Small/Bltn/2-Stk/3-Stk [2]
Select the type of guitar amp.	
Small	: small amp
Bltn	: single-unit type amp
2-Stk	: large double stack amp
3-Stk	: large triple stack amp

Amp Sw (Amp switch)	Off/On [3]
Turn the Amp Type on/off.	
Low Gain	-12 - +12 [17]
Adjust the gain of the low frequency range.	
Hi Gain (High gain)	-12 - +12 [18]
Adjust the gain of the high frequency range.	
#Pan (Output pan)	L63 - 0 - R63 [19]
Adjust the stereo location of the output sound. L63 is far left, 0 is center, and R63 is far right.	
Level (Output level)	0 - 127 [20]
Adjust the output level.	

○ **Effects that modulate the sound (modulation type)**

7: Phaser [01H, 20H]

A phaser adds a phase-shifted sound to the original sound, producing a twisting modulation that creates spaciousness and depth.

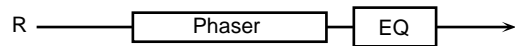
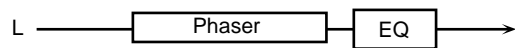

+Manual	100 - 8.0k [1]
Adjust the basic frequency from which the sound will be modulated.	
#Rate	0.05 - 10.0 [2]
Adjust the frequency (period) of modulation.	
Depth	0 - 127 [3]
Adjust the depth of modulation.	
Reso (Resonance)	0 - 127 [4]
Adjust the amount of emphasis added to the frequency range surrounding the basic frequency determined by the Manual parameter setting.	
Mix (Mix level)	0 - 127 [5]
Adjust the ratio with which the phase-shifted sound is combined with the direct sound.	
Low Gain	-12 - +12 [17]
Adjust the gain of the low frequency range.	
Hi Gain (High gain)	-12 - +12 [18]
Adjust the gain of the high frequency range.	
Level (Output level)	0 - 127 [20]
Adjust the output level.	

8: Auto Wah [01H, 21H]

The Auto Wah cyclically controls a filter to create cyclic change in timbre.

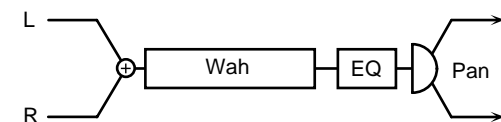

Fil Type (Filter Type)	LPF/BPF [1]
Select the type of filter.	
LPF	: The wah effect will be applied over a wide frequency range.
BPF	: The wah effect will be applied over a narrow frequency range.

Sens (Sensitivity)	0 - 127 [2]
Adjust the sensitivity with which the filter is controlled. If this value is increased, the filter frequency will change more readily in response to the input level.	
+Manual	0 - 127 [3]
Adjust the center frequency from which the effect is applied.	

Peak 0 - 127 [4]
Adjust the amount of the wah effect that will occur in the area of the center frequency. Lower settings will cause the effect to be applied in a broad area around the center frequency. Higher settings will cause the effect to be applied in a more narrow range. In the case of LPF, decreasing the value will cause the wah effect to change less.

#Rate 0.05 - 10.0 [5]
Adjust the speed of the modulation.

Depth 0 - 127 [6]
Adjust the depth of the modulation.

Polarity Down/Up [7]
Set the direction in which the frequency will change when the filter is modulated. With a setting of Up, the filter will change toward a higher frequency. With a setting of Down it will change toward a lower frequency.

Low Gain -12 - +12 [17]
Adjust the gain of the low frequency range for EQ.

Hi Gain (High gain) -12 - +12 [18]
Adjust the gain of the high frequency range for EQ.

Pan (Output pan) L63 - 0 - R63 [19]
Adjust the stereo location of the output sound. L63 is far left, 0 is center, and R63 is far right.

Level (Output level) 0 - 127 [20]
Adjust the output level.

Low Level (Low frequency level) 0 - 127 [4]
Adjust the volume of the low frequency rotor.

Hi Slow (High frequency slow rate) 0.05 - 10.0 [5]
Adjust the slow speed (Slow) of the high frequency rotor.

Hi Fast (High frequency fast rate) 0.05 - 10.0 [6]
Adjust the fast speed (Fast) of the high frequency rotor.

Hi Accl (High frequency acceleration) 0 - 15 [7]
Adjust the time it takes for the high frequency rotor to reach the newly selected speed when switching from fast to slow (or slow to fast) speed. Lower values will require longer times.

Hi Level (High frequency level) 0 - 127 [8]
Adjust the volume of the high frequency rotor.

Separate (Separation) 0 - 127 [9]
Adjust the spatial dispersion of the sound.

+Speed Slow/Fast [11]
Simultaneously switch the rotational speed of the low frequency rotor and high frequency rotor.

Slow : Slow down the rotation to the specified speed (the Low Slow parameter / Hi Slow parameter values).

Fast : Speed up the rotation to the specified speed (the Low Fast parameter / Hi Fast parameter values).

Low Gain -12 - +12 [17]
Adjust the gain of the low frequency range for EQ.

Hi Gain (High gain) -12 - +12 [18]
Adjust the gain of the high frequency range for EQ.

#Level (Output level) 0 - 127 [20]
Adjust the output level.

9: Rotary [01H, 22H]

The Rotary effect simulates the sound of a classic rotary speakers. Since the movement of the high range and low range rotors can be set independently, the unique type of modulation characteristic of these speakers can be simulated quite closely. This effect is most suitable for electric organ.

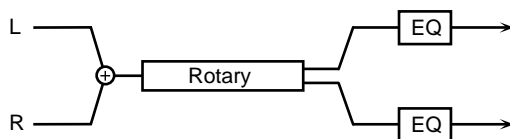

Low Slow (Low frequency slow rate) 0.05 - 10.0 [1]
Adjust the slow speed (Slow) of the low frequency rotor.

Low Fast (Low frequency fast rate) 0.05 - 10.0 [2]
Adjust the fast speed (Fast) of the low frequency rotor.

Low Accl (Low frequency acceleration) 0 - 15 [3]
Adjust the time it takes for the low frequency rotor to reach the newly selected speed when switching from fast to slow (or slow to fast) speed. Lower values will require longer times.

10: Stereo Flanger [01H, 23H]

This is a stereo flanger. It produces a metallic resonance that rises and falls like a jet airplane taking off or landing. A filter is provided so that you can adjust the timbre of the flanged sound.

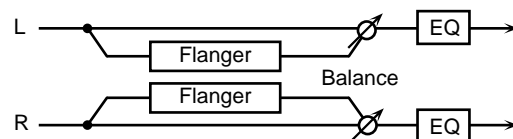

Pre Filter (Pre filter type) Off/LPF/HPF [1]
Select the type of filter.

Off : a filter will not be used

LPF : cut the frequency range above the Cutoff parameter

HPF : cut the frequency range below the Cutoff parameter

Cutoff (Cutoff frequency) 250 - 8k [2]
Adjust the basic frequency of the filter.

Pre Dly (Pre delay time) 0 - 100m [3]
Adjust the time delay from when the direct sound begins until the processed sound is heard.

+Rate 0.05 - 10.0 [4]
Adjust the rate of modulation.

Depth 0 - 127 [5]
Adjust the depth of modulation.

#Feedback (Feedback level) -98% - +98% [6]
Adjust the amount (%) of the processed sound that is returned (fed back) into the input. Negative (-) settings will invert the phase.

Phase 0 - 180 [7]
Adjust the spatial spread of the sound.

Balance (Effect balance) D > 0E - D 0 < E [16]
Adjust the volume balance between the direct and the processed sound.
“D” or “E” on the display respectively means D(direct sound) or E(effect sound) values of 100.

Low Gain -12 - +12 [17]
Adjust the gain of the low frequency range.

Hi Gain (High Gain) -12 - +12 [18]
Adjust the gain of the high frequency range.

Level (Output level) 0 - 127 [20]
Adjust the output level.

Depth 0 - 127 [3]
Adjust the depth of modulation.

+Feedback (Feedback level) -98% - +98% [4]
Adjust the amount (%) of the processed sound that is returned (fed back) into the input. Negative (-) settings will invert the phase.

Phase 0 - 180 [5]
Adjust the spatial spread of the sound.

#Step Rate 0.05 - 10.0 [6]
Adjust the rate (period) of pitch change.

Balance (Effect balance) D > 0E - D 0 < E [16]
Adjust the volume balance between the direct and the processed sound.
“D” or “E” on the display respectively means D(direct sound) or E(effect sound) values of 100.

Low Gain -12 - +12 [17]
Adjust the gain of the low frequency range.

Hi Gain (High gain) -12 - +12 [18]
Adjust the gain of the high frequency range.

Level (Output level) 0 - 127 [20]
Adjust the output level.

12: Tremolo [01H, 25H]

Tremolo cyclically modulates the volume to add tremolo effect to the sound.

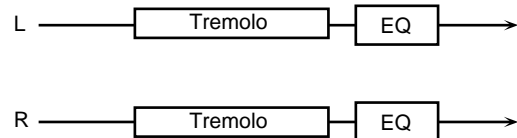

Mod Wave (Modulation wave) Tri/Sqr/Sin/Saw1/Saw2 [1]
Select the type of modulation.

- Tri** : The sound will be modulated like a triangle wave.
- Sqr** : The sound will be modulated like a square wave.
- Sin** : The sound will be modulated like a sine wave.
- Saw1,2** : The sound will be modulated like a sawtooth wave. The “teeth” in Saw1 and Saw2 point at opposite directions.



+Mod Rate (Modulation rate) 0.05 - 10.0 [2]
Adjust the speed of modulation.

#Mod Depth (Modulation depth) 0 - 127 [3]
Adjust the depth of modulation.

11: Step Flanger [01H, 24H]

The Step Flanger is an effect in which the flanger pitch changes in steps.

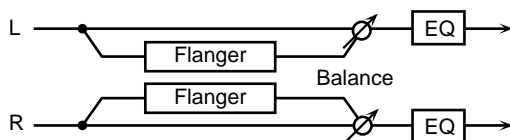

Pre Dly (Pre delay time) 0 - 100m [1]
Adjust the time delay from when the direct sound begins until the processed sound is heard.

Rate 0.05 - 10.0 [2]
Adjust the rate of modulation.

Low Gain	-12 - +12 [17]
Adjust the gain of the low frequency range.	
Hi Gain (High gain)	-12 - +12 [18]
Adjust the gain of the high frequency range.	
Level (Output level)	0 - 127 [20]
Adjust the output level.	

13: Auto Pan [01H, 26H]

The Auto Pan effect cyclically modulates the stereo location of the sound.

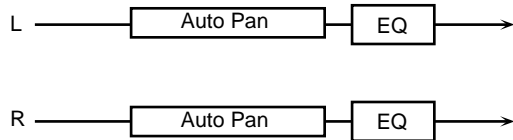

Mod Wave (Modulation wave) Tri/Sqr/Sin/Saw1/Saw2 [1]
Select the type of modulation.

- Tri** : The sound will be modulated like a triangle wave.
- Sqr** : The sound will be modulated like a square wave.
- Sin** : The sound will be modulated like a sine wave.
- Saw1,2** : The sound will be modulated like a sawtooth wave. The "teeth" in Saw1 and Saw2 point at opposite direction.



+Mod Rate (Modulation rate)	0.05 - 10.0 [2]
Adjust the frequency of modulation.	
#Mod Depth (Modulation depth)	0 - 127 [3]
Adjust the depth of modulation.	
Low Gain	-12 - +12 [17]
Adjust the gain of the low frequency range.	
Hi Gain (High gain)	-12 - +12 [18]
Adjust the gain of the high frequency range.	
Level (Output level)	0 - 127 [20]
Adjust the output level.	

○ Effects that affect the level (compressor type)

14: Compressor [01H, 30H]

The Compressor flattens out high levels and boosts low levels, smoothing out unevenness in volume.

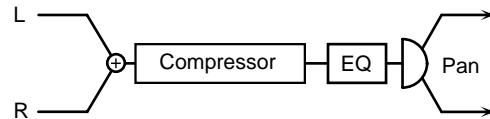

Attack	0 - 127 [1]
Adjust the attack time of an input sound.	
Sustain	0 - 127 [2]
Adjust the time over which low level sounds are boosted until they reach the specified volume.	
Increasing the value will shorten the time. When the value is modified, the level will also change.	
Post Gain	0/+6/+12/+18 [3]
Adjust the output gain.	
Low Gain	-12 - +12 [17]
Adjust the low frequency gain.	
Hi Gain (High gain)	-12 - +12 [18]
Adjust the high frequency gain.	
+Pan (Output pan)	L63 - 0 - R63 [19]
Adjust the stereo location of the output sound. L63 is far left, 0 is center, and R63 is far right.	
#Level (Output level)	0 - 127 [20]
Adjust the output level.	

15: Limiter [01H, 31H]

The Limiter compresses signals that exceed a specified volume level, preventing distortion from occurring.

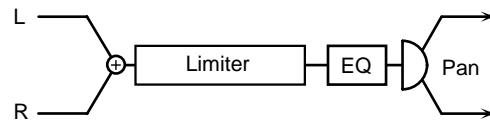

Threshold (Threshold level)	0 - 127 [1]
Adjust the volume at which compression will begin.	
Ratio (Compression ratio)	1/1.5, 1/2, 1/4, 1/100 [2]
This adjusts the compression ratio for signals that are louder than the Threshold Level. 1/100 is the highest compression ratio, and the output level will decrease.	
Release (Release time)	0 - 127 [3]
Adjust the time from when the volume falls below the Threshold Level until compression is no longer applied.	
Post Gain	0/+6/+12/+18 [4]
Adjust the output gain.	
Low Gain	-12 - +12 [17]
Adjust the low frequency gain.	
Hi Gain (High gain)	-12 - +12 [18]
Adjust the high frequency gain.	

+Pan (Output pan) L63 - 0 - R63 [19]
Adjust the stereo location of the output sound. L63 is far left, 0 is center, and R63 is far right.

#Level (Output level) 0 - 127 [20]
Adjust the output level.

○ Effects that broaden the sound (chorus type)

16: Hexa Chorus [01H, 40H]

Hexa-chorus uses a six-phase chorus (six layers of chorused sound) to give richness and spatial spread to the sound.

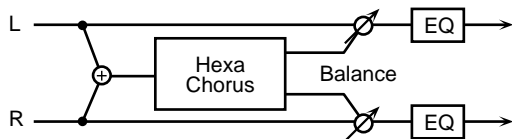

Pre Dly (Pre delay time) 0 - 100m [1]
Adjust the time delay from when the direct sound begins until the processed sound is heard.

+Rate 0.05 - 10.0 [2]
Adjust the rate of modulation.

Depth 0 - 127 [3]
Adjust the depth of modulation.

Pre Dly Dev (Pre delay deviation) 0 - 20 [4]
The Pre Delay is the time from when the original sound begins until when the chorus sound is heard. This adjusts the difference in Pre Delay between each of the six phases of chorus sound.

Depth Dev (Depth deviation) -20 - +20 [5]
Adjust the difference in modulation depth between each of the six phases of chorus sound.

Pan Dev (Pan deviation) 0 - 20 [6]
Adjust the difference in stereo position between each of the six phases of chorus sound. With a setting of 0, all the chorus sound will be located in the center. With a setting of 20, each chorus sound will be placed in 30 degree intervals relative to the center position.

#Balance (Effect balance) D > 0E - D 0 < E [16]
Adjust the volume balance between the direct and the processed sound.

“D” or “E” on the display respectively means D(direct sound) or E(effect sound) values of 100.

Low Gain -12 - +12 [17]
Adjust the low frequency gain.

Hi Gain (High gain) -12 - +12 [18]
Adjust the high frequency gain.

Level (Output level) 0 - 127 [20]
Adjust the output level.

17: Tremolo Chorus [01H, 41H]

Tremolo Chorus is a chorus effect with added Tremolo (cyclic modulation of volume).

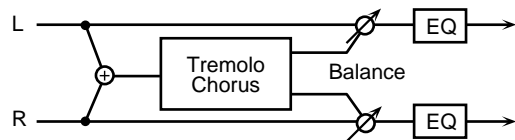

Pre Dly (Pre delay time) 0 - 100m [1]
Adjust the time delay from when the direct sound begins until the chorus sound is heard.

Cho Rate (Chorus rate) 0.05 - 10.0 [2]
Adjust the modulation speed of the chorus effect.

Cho Depth (Chorus depth) 0 - 127 [3]
Adjust the modulation depth of the chorus effect.

Trem Phase (Tremolo phase) 0 - 180 [4]
Adjust the width of the tremolo sound.

+Trem Rate (Tremolo rate) 0.05 - 10.0 [5]
Adjust the modulation speed of the tremolo effect.

Trem Sep (Tremolo separation) 0 - 127 [6]
Adjust the spatial spread of the tremolo effect.

#Balance (Effect balance) D > 0E - D 0 < E [16]
Adjust the volume balance between the direct and the processed sound.

“D” or “E” on the display respectively means D(direct sound) or E(effect sound) values of 100.

Low Gain -12 - +12 [17]
Adjust the low frequency gain.

Hi Gain (High gain) -12 - +12 [18]
Adjust the high frequency gain.

Level (Output level) 0 - 127 [20]
Adjust the output level.

18: Stereo Chorus [01H, 42H]

This is a stereo chorus. A filter is provided so that you can adjust the timbre of the chorus sound.

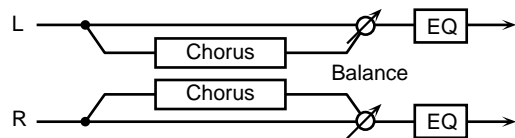

Pre Filter (Pre filter type) Off/LPF/HPF [1]
Select the type of filter.

- Off** : a filter will not be used
- LPF** : cut the frequency range above the cutoff
- HPF** : cut the frequency range below the cutoff

Cutoff (Cutoff frequency)	250 - 8k [2]
Adjust the center frequency of the filter for the chorus sound for the chorus sound.	
Pre Dly (Pre delay time)	0 - 100m [3]
Adjust the time delay from when the direct sound begins until the processed sound is heard.	
+Rate	0.05 - 10.0 [4]
Adjust the rate of modulation.	
Depth	0 - 127 [5]
Adjust the depth of modulation.	
Phase	0 - 180 [7]
Adjust the spatial spread of the sound.	
#Balance (Effect balance)	D > 0E - D 0 < E [16]
Adjust the volume balance between the direct and the processed sound.	
"D" or "E" on the display respectively means D(direct sound) or E(effect sound) values of 100.	
Low Gain	-12 - +12 [17]
Adjust the gain of the low frequency range.	
Hi Gain (High gain)	-12 - +12 [18]
Adjust the gain of the high frequency range.	
Level (Output level)	0 - 127 [20]
Adjust the output level.	

19: Space D [01H, 43H]

Space-D is a multiple chorus that applies two-phase modulation in stereo. It gives no impression of modulation, but produces a transparent chorus effect.

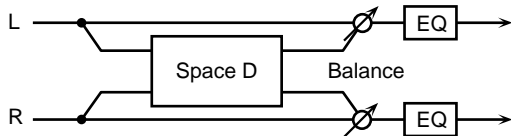

Pre Dly (Pre delay time)	0 - 100m [1]
Adjust the time delay from when the direct sound begins until the processed sound is heard.	
+Rate	0.05 - 10.0 [2]
Adjust the rate of modulation.	
Depth	0 - 127 [3]
Adjust the depth of modulation.	
Phase	0 - 180 [4]
Adjust the spatial spread of the sound.	
#Balance (Effect balance)	D > 0E - D 0 < E [16]
Adjust the volume balance between the direct and the processed sound.	
"D" or "E" on the display respectively means D(direct sound) or E(effect sound) values of 100.	

Low Gain	-12 - +12 [17]
Adjust the gain of the low frequency range.	
Hi Gain (High gain)	-12 - +12 [18]
Adjust the gain of the high frequency range.	
Level (Output level)	0 - 127 [20]
Adjust the output level.	

20: 3D Chorus [01H, 44H]

This applies a 3D effect to the chorus sound. The chorus sound will be positioned 90 degrees left and 90 degrees right.

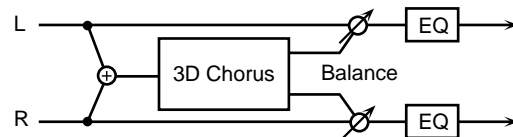

Pre Dly (Pre delay time)	0 - 100m [1]
Adjust the time delay from when the direct sound begins until the processed sound is heard.	
+Cho Rate (Chorus Rate)	0.05 - 10.0 [2]
Adjust the modulation speed of the chorus sound.	
Cho Depth (Chorus Depth)	0 - 127 [3]
Adjust the modulation depth of the chorus sound.	

Out (Output Mode) Speaker/Phones [15]
Specify the method that will be used to hear the sound which is output to the OUTPUT jacks. The optimal 3D effect will be achieved if you select Speaker when using speakers, or Phones when using headphones (p.91).

#Balance (Effect balance) D > 0E - D 0 < E [16]
Adjust the volume balance between the direct and the processed sound.
"D" or "E" on the display respectively means D(direct sound) or E(effect sound) values of 100.

Low Gain	-12 - +12 [17]
Adjust the gain of the low frequency range.	
Hi Gain (High gain)	-12 - +12 [18]
Adjust the gain of the high frequency range.	
Level (Output level)	0 - 127 [20]
Adjust the output level.	

○ Effects that reverberate the sound (delay/reverb type)

21: Stereo Delay [01H, 50H]

This is a stereo delay.

Fb Mode is Norm:

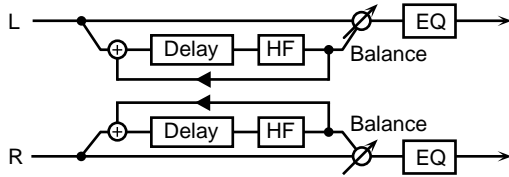

Fb Mode is Cross:

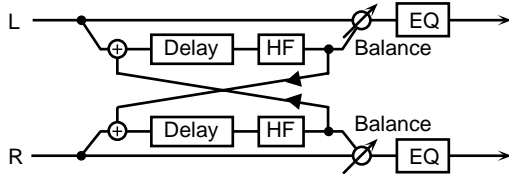

Dly Tm L (Delay time left) 0 - 500m [1]

Adjust the time from the original sound until when the left delay sound is heard.

Dly Tm R (Delay time right) 0 - 500m [2]

Adjust the time from the original sound until when the right delay sound is heard.

+Feedback (Feedback level) -98% - +98% [3]

Adjust the proportion (%) of the processed sound that is fed back into the effect. Negative (-) settings will invert the phase.

Fb Mode (Feedback mode) Norm/Cross [4]

Select the way in which processed sound is fed back into the effect.

Norm : The left delay sound will be fed back into the left delay, and the right delay sound into the right delay.

Cross : The left delay sound will be fed back into the right delay, and the right delay sound into the left delay.

Phase L (Phase left) Norm/Invert [5]

Select the phase of the left delay sound.

Norm : Phase will not be changed.

Invert : Phase will be inverted.

Phase R (Phase right) Norm/Invert [6]

Select the phase of the right delay sound.

Norm : Phase will not be changed.

Invert : Phase will be inverted.

HF Damp 315 - 8k/Bypass [8]

Adjust the frequency above which sound fed back to the effect will be cut. If you do not want to cut the high frequencies of the feedback, set this parameter to Bypass.

#Balance (Effect balance) D> 0E - D 0<E [16]

Adjust the volume balance between the direct and the processed sound.

“D” or “E” on the display respectively means D(direct sound) or E(effect sound) values of 100.

Low Gain -12 - +12 [17]

Adjust the gain of the low frequency range.

Hi Gain (High gain) -12 - +12 [18]

Adjust the gain of the high frequency range.

Level (Output level) 0 - 127 [20]

Adjust the output level.

22: Mod Delay (Modulation Delay) [01H, 51H]

This effect adds modulation to the delayed sound, producing an effect similar to a flanger.

Fb Mode is Norm:

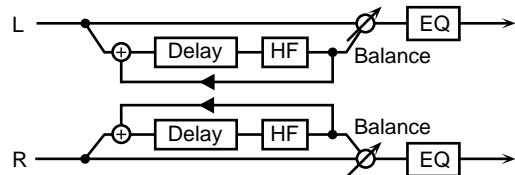

Fb Mode is Cross:

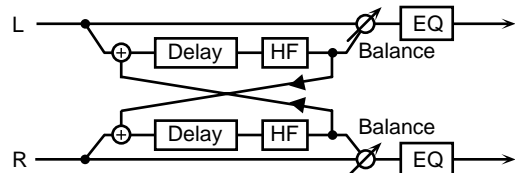

Dly Tm L (Delay time left) 0 - 500m [1]

Adjust the time from the original sound until when the left delay sound is heard.

Dly Tm R (Delay time right) 0 - 500m [2]

Adjust the time from the original sound until when the right delay sound is heard.

Feedback (Feedback level) -98% - +98% [3]

Adjust the proportion (%) of the processed sound that is fed back into the effect. Negative (-) settings will invert the phase.

Fb Mode (Feedback mode) Norm/Cross [4]

Select the way in which processed sound is fed back into the effect.

Norm : The left delay sound will be fed back into the left delay, and the right delay sound into the right delay.

Cross : The left delay sound will be fed back into the right delay, and the right delay sound into the left delay.

+Mod Rate (Modulation rate) 0.05 - 10.0 [5]

Adjust the speed of the modulation.

Mod Depth (Modulation depth) 0 - 127 [6]

Adjust the depth of the modulation.

Mod Phase (Modulation phase) 0 - 180 [7]

Adjust the spatial spread of the sound.

HF Damp 315 - 8k/Bypass [8]
Adjust the frequency above which sound fed back to the effect will be cut. If you do not wish to cut the high frequencies of the feedback, set this parameter to Bypass.

#Balance (Effect balance) D > 0E - D 0 < E [16]
Adjust the volume balance between the direct and the processed sound.
“D” or “E” on the display respectively means D(direct sound) or E(effect sound) values of 100.

Low Gain -12 - +12 [17]
Adjust the gain of the low frequency range.

Hi Gain (High gain) -12 - +12 [18]
Adjust the gain of the high frequency range.

Level (Output level) 0 - 127 [20]
Adjust the output level.

HF Damp 315 - 8k/Bypass [8]
This adjusts the frequency at which the high range is cut when the Center Delay sound is returned to the input. If you do not wish to cut the high range, set this to Bypass.

#Balance (Effect balance) D > 0E - D 0 < E [16]
Adjust the volume balance between the direct and the processed sound.
“D” or “E” on the display respectively means D(direct sound) or E(effect sound) values of 100.

Low Gain -12 - +12 [17]
Adjust the gain of the low frequency range.

Hi Gain (High gain) -12 - +12 [18]
Adjust the gain of the high frequency range.

Level (Output level) 0 - 127 [20]
Adjust the output level.

23: 3 Tap Delay (Triple tap delay) [01H, 52H]

The Triple Tap Delay produces three delay sounds; center, left and right.

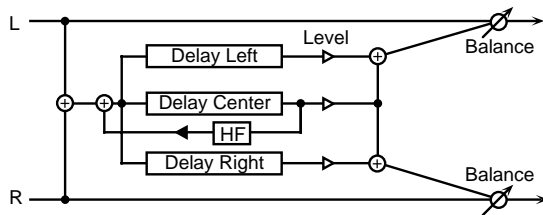

Dly Tm C (Delay time center) 200m - 990m/1sec [1]
Adjust the time delay from the direct sound until when the center delay sound is heard.

Dly Tm L (Delay time left) 200m - 990m/1sec [2]
Adjust the time delay from the direct sound until when the left delay sound is heard.

Dly Tm R (Delay time right) 200m - 990m/1sec [3]
Adjust the time delay from the direct sound until when the right delay sound is heard.

+Feedback (Feedback level) -98% - +98% [4]
Adjust the proportion (%) of the Center Delay sound that is fed back into the effect. Negative (-) settings will invert the phase.

Dly Lev C (Delay level center) 0 - 127 [5]
Adjust the volume of center delay sound.

Dly Lev L (Delay level left) 0 - 127 [6]
Adjust the volume of left delay sound.

Dly Lev R (Delay level right) 0 - 127 [7]
Adjust the volume of right delay sound.

24: 4 Tap Delay (Quadruple tap delay)

[01H, 53H]

The Quadruple Tap Delay has four delays.

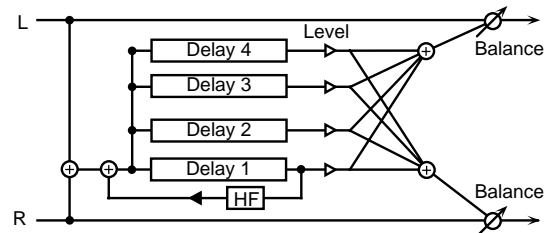

Dly Tm 1 (Delay time 1) 200m - 990m/1sec [1]
Adjust the time delay from the direct sound until when delay 1 sound is heard.

Dly Tm 2 (Delay time 2) 200m - 990m/1sec [2]
Adjust the time delay from the direct sound until when delay 2 sound is heard.

Dly Tm 3 (Delay time 3) 200m - 990m/1sec [3]
Adjust the time delay from the direct sound until when delay 3 sound is heard.

Dly Tm 4 (Delay time 4) 200m - 990m/1sec [4]
Adjust the time delay from the direct sound until when delay 4 sound is heard.

Dly Lev 1 (Delay level 1) 0 - 127 [5]
Adjust the volume of delay 1 sound.

Dly Lev 2 (Delay level 2) 0 - 127 [6]
Adjust the volume of delay 2 sound.

Dly Lev 3 (Delay level 3) 0 - 127 [7]
Adjust the volume of delay 3 sound.

Dly Lev 4 (Delay level 4) 0 - 127 [8]
Adjust the volume of delay 4 sound.

+Feedback (Feedback level) -98% - +98% [9]
Adjust the proportion (%) of the Delay 1 sound that is fed back into the effect. Negative (-) settings will invert the phase.

HF Damp 315 - 8k/Bypass [10]
This adjusts the frequency at which the high range is cut when the Delay 1 sound is returned to the input. If you do not wish to cut the high range, set this to Bypass.

#Balance (Effect balance) D > 0 E - D 0 < E [16]
Adjust the volume balance between the direct and the processed sound.
“D” or “E” on the display respectively means D(direct sound) or E(effect sound) values of 100.

Low Gain -12 - +12 [17]
Adjust the gain of the low frequency range.

Hi Gain (High gain) -12 - +12 [18]
Adjust the gain of the high frequency range.

Level (Output level) 0 - 127 [20]
Adjust the output level.

25: Tm Ctrl Delay (Time control delay) [01H, 54H]

This effect allows you to use a specified controller (the controller selected in EFX C.Src display (p.92) to control the delay time and pitch in realtime. Lengthening the delay time will lower the pitch, and shortening it will raise the pitch.

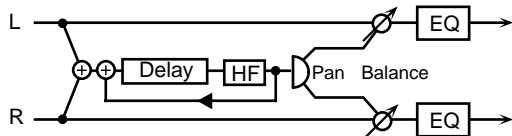

+Dly Time (Delay time) 200m - 990m/1sec [1]
Adjust the time delay from the direct sound until when each delay sound is heard.

Accel (Acceleration) 0 - 15 [2]
This parameter adjusts the speed over which the Delay Time will change from the current setting to a newly specified setting. The rate of change for the Delay Time directly affects the rate of pitch change.

#Feedback (Feedback level) -98% - +98% [3]
Adjust the proportion (%) of the processed sound that is fed back into the effect. Negative (-) settings will invert the phase.

HF Damp 315 - 8k/Bypass [4]
Adjust the frequency above which sound fed back to the effect will be cut. If you do not wish to cut the high frequencies of the feedback, set this parameter to Bypass.

EFX Pan (Effect output pan) L63 - 0 - R63 [5]
Adjust the stereo location of the processed sound. L63 is far left, 0 is center, and R63 is far right.

Balance (Effect balance) D > 0 E - D 0 < E [16]
Adjust the volume balance between the direct and the processed sound.
“D” or “E” on the display respectively means D(direct sound) or E(effect sound) values of 100.

Low Gain -12 - +12 [17]
Adjust the gain of the low frequency range.

Hi Gain (High gain) -12 - +12 [18]
Adjust the gain of the high frequency range.

Level (Output level) 0 - 127 [20]
Adjust the output level.

26: Reverb [01H, 55H]

The Reverb effect adds reverberation to the sound, simulating an acoustic space.

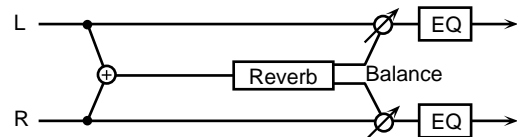

Type (Reverb type)

Room1/2/Stage1/2/Hall1/2 [1]

Select the type of Reverb effect.

- Room1** : dense reverb with short decay
- Room2** : sparse reverb with short decay
- Stage1** : reverb with greater late reverberation
- Stage2** : reverb with strong early reflections
- Hall1** : reverb with clear reverberance
- Hall2** : reverb with rich reverberance

Pre Dly (Pre delay time) 0 - 100m [2]
Adjust the time delay from when the direct sound begins until the reverb sound is heard.

+Time (Reverb time) 0 - 127 [3]
Adjust the time length of reverberation.

HF Damp 315 - 8k/Bypass [4]
Adjust the frequency above which the reverberant sound will be cut. As the frequency is set lower, more of the high frequencies will be cut, resulting in a softer and more muted reverberance. If you do not want the high frequencies to be cut, set this parameter to Bypass.

#Balance (Effect balance) D > 0 E - D 0 < E [16]
Adjust the volume balance between the direct and the processed sound.
“D” or “E” on the display respectively means D(direct sound) or E(effect sound) values of 100.

- Low Gain -12 - +12 [17]
Adjust the gain of the low frequency range.
- Hi Gain (High gain) -12 - +12 [18]
Adjust the gain of the high frequency range.
- Level (Output level) 0 - 127 [20]
Adjust the output level.

27: Gate Reverb [01H, 56H]

Gate Reverb is a special type of reverb in which the reverberant sound is cut off before its natural length.

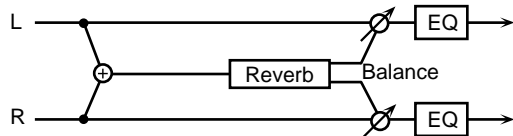

Type (Gate reverb type) Norm/Reverse/Sweep1/2 [1]
Select the type of reverb.

- Norm** : conventional gate reverb
- Reverse** : backwards reverb
- Sweep1** : the reverberant sound moves from right to left
- Sweep2** : the reverberant sound moves from left to right

Pre Dly (Pre delay time) 0 - 100m [2]
Adjust the time delay from when the direct sound begins until the reverb sound is heard.

Gate Time 5 - 500m [3]
Adjust the time from when the reverb is heard until when it disappears.

+Balance (Effect balance) D> 0E - D 0<E [16]
Adjust the volume balance between the direct and the processed sound.
“D” or “E” on the display respectively means D(direct sound) or E(effect sound) values of 100.

Low Gain -12 - +12 [17]
Adjust the gain of the low frequency range.

Hi Gain (High gain) -12 - +12 [18]
Adjust the gain of the high frequency range.

#Level (Output level) 0 - 127 [20]
Adjust the output level.

28: 3D Delay [01H, 57H]

This applies a 3D effect to the delay sound. The delay sound will be positioned 90 degrees left and 90 degrees right.

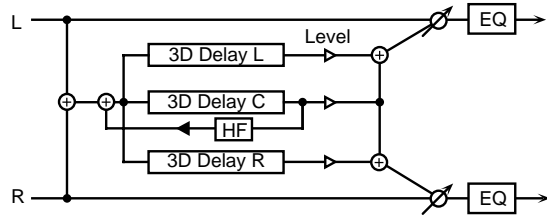

Dly Tm C (Delay Time Center) 0m - 500m [1]
Adjust the time from the original sound until when the center delay sound begins.

Dly Tm L (Delay Time Left) 0m - 500m [2]
Adjust the time from the original sound until when the left delay sound begins.

Dly Tm R (Delay Time Right) 0m - 500m [3]
Adjust the time from the original sound until when the right delay sound begins.

+Feedback (Delay Feedback) -98% - +98% [4]
Adjust the amount (%) of the center delay sound that will be returned to the input. With negative (-) settings, the phase will be inverted.

Dly Lev C (Delay Level Center) 0 - 127 [5]
Adjust the volume of the center delay sound.

Dly Lev L (Delay Level Left) 0 - 127 [6]
Adjust the volume of the left delay sound.

Dly Lev R (Delay Level Right) 0 - 127 [7]
Adjust the volume of the right delay sound.

HF Damp 315 - 8k/Bypass [8]
This adjusts the frequency at which the high range is cut when the Center Delay sound is returned to the input. If you do not wish to cut the high range, set this to Bypass.

Out (Output Mode) Speaker/Phones [15]
Specify the method that will be used to hear the sound which is output to the OUTPUT jacks. The optimal 3D effect will be achieved if you select Speaker when using speakers, or Phones when using headphones (p.91).

#Balance (Effect balance) D> 0E - D 0<E [16]
Adjust the volume balance between the direct and the processed sound.
“D” or “E” on the display respectively means D(direct sound) or E(effect sound) values of 100.

Low Gain -12 - +12 [17]
Adjust the gain of the low frequency range.

Hi Gain (High gain) -12 - +12 [18]
Adjust the gain of the high frequency range.

Level (Output level) 0 - 127 [20]
Adjust the output level.

○ **Effects that modify the pitch (pitch shift type)**

29: 2 Pitch Shifter (2-voice pitch shifter)

[01H, 60H]

A Pitch Shifter shifts the pitch of the original sound. This 2-voice pitch shifter has two pitch shifters, and can add two pitch shifted sounds to the original sound.

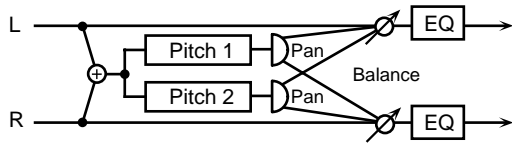

+Coarse 1 (Coarse pitch 1) -24 - 0 - +12 [1]
Adjust the pitch of Pitch Shift 1 in semitone steps (-2 - +1 octaves).

Fine 1 (Fine pitch 1) -100 - 0 - +100 [2]
Make fine adjustments to the pitch of Pitch Shift 1 in 2-cent steps (-100 - +100 cents).

Pre Dly 1 (Pre delay time 1) 0 - 100m [3]
Adjust the time delay from when the direct sound begins until the Pitch Shift 1 sound is heard.

EFX Pan 1 (Effect output pan 1) L63 - 0 - R63 [4]
Adjust the stereo location of the Pitch Shift 1 sound. L63 is far left, 0 is center, and R63 is far right.

#Coarse 2 (Coarse pitch 2) -24 - 0 - +12 [5]
Adjust the pitch of Pitch Shift 2 in semitone steps (-2 - +1 octaves).

Fine 2 (Fine pitch 2) -100 - 0 - +100 [6]
Make fine adjustments to the pitch of Pitch Shift 2 in 2-cent steps (-100 - +100 cents).

Pre Dly 2 (Pre delay time 2) 0 - 100m [7]
Adjust the time delay from when the direct sound begins until the Pitch Shift 2 sound is heard.

EFX Pan 2 (Effect output pan 2) L63 - 0 - R63 [8]
Adjust the stereo location of the Pitch Shift 2 sound. L63 is far left, 0 is center, and R63 is far right.

Shift Mode (Pitch shifter mode) 1 - 5 [9]
Higher settings of this parameter will result in slower response, but steadier pitch.

L.Bal (Level balance) A > 0B - A 0 < B [10]
Adjust the volume balance between the Pitch Shift 1 and Pitch Shift 2 sounds.

Balance (Effect balance) D > 0E - D 0 < E [16]
Adjust the volume balance between the direct and the processed sound.

“D” or “E” on the display respectively means D(direct sound) or E(effect sound) values of 100.

Low Gain -12 - +12 [17]
Adjust the gain of the low frequency range.

Hi Gain (High gain) -12 - +12 [18]
Adjust the gain of the high frequency range.

Level (Output level) 0 - 127 [20]
Adjust the output level.

30: Fb P.Shifter (Feedback pitch shifter)

[01H, 61H]

This pitch shifter allows the pitch shifted sound to be returned into the effect.

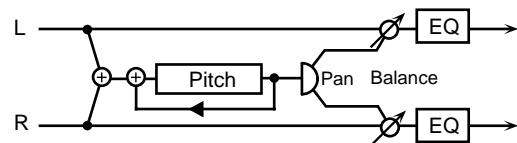

+P.Coarse (Coarse pitch) -24 - 0 - +12 [1]
Adjust the pitch of the pitch shifted sound in semitone steps (-2 - +1 octaves).

P.Fine (Fine pitch) -100 - 0 - +100 [2]
Make fine adjustments to the pitch of the pitch shifted sound in 2-cent steps (-100 - +100 cents).

#Feedback (Feedback level) -98% - +98% [3]
Adjust the proportion (%) of the processed sound that is fed back into the effect. Negative (-) settings will invert the phase.

Pre Dly (Pre delay time) 0 - 100m [4]
Adjust the time delay from when the direct sound begins until the pitch shifted sound is heard.

Mode (Pitch shifter mode) 1 - 5 [5]
Higher settings of this parameter will result in slower response, but steadier pitch.

EFX Pan (Effect output pan) L63 - 0 - R63 [6]
Adjust the stereo location of the pitch shifted sound. L63 is far left, 0 is center, and R63 is far right.

Balance (Effect balance) D > 0E - D 0 < E [16]
Adjust the volume balance between the direct and the processed sound.

“D” or “E” on the display respectively means D(direct sound) or E(effect sound) values of 100.

Low Gain -12 - +12 [17]
Adjust the gain of the low frequency range.

Hi Gain (High gain) -12 - +12 [18]
Adjust the gain of the high frequency range.

Level (Output level) 0 - 127 [20]
Adjust the output level.

○ Others

31: 3D Auto [01H, 70H]

The 3D Auto effect rotates the location of the sound.

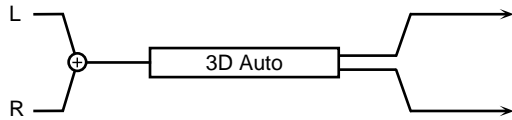

Azimuth 180/L168 - 0 - R168 [1]
Set the location at which the sound will stop when rotation is stopped.

A setting of 0 positions the sound in the center.

+Speed 0.05 - 10.0 [2]
Set the speed of rotation.

Clockwise -/+ [3]
Set the direction of rotation. A setting of "-" is counter-clockwise, and "+" is clockwise.

#Turn Off/On [4]
This stops or starts the rotation. When this is turned On, the sound will rotate. When turned Off, rotation will stop at the location specified by Azimuth.

Out (Output mode) Speaker/Phones [15]
Specify the method that will be used to hear the sound which is output to the OUTPUT jacks. The optimal 3D effect will be achieved if you select Speaker when using speakers, or Phones when using headphones (p.91).

Level (Output level) 0 - 127 [20]
Adjust the output level.

32: 3D Manual [01H, 71H]

This places the 3D effect at a desired location.

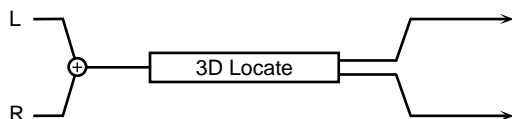

+Azimuth 180/L168 - 0 - R168 [1]
Specify the location.
A setting of 0 positions the sound in the center.

Out (Output mode) Speaker/Phones [15]
Specify the method that will be used to hear the sound which is output to the OUTPUT jacks. The optimal 3D effect will be achieved if you select Speaker when using speakers, or Phones when using headphones (p.91).

#Level (Output level) 0 - 127 [20]
Adjust the output level.

33: Lo-Fi 1 [01H, 72H]

Lo-Fi 1 is an effect that intentionally degrades the sound quality.

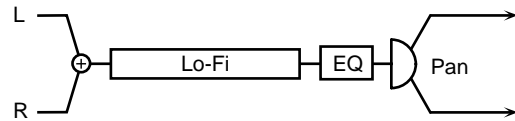

Pre Filter (Pre Filter Type) 1 - 6 [1]
Specify the type of filter that will be applied before the sound passes through the Lo-Fi effect.

Lo-Fi Type 1 - 9 [2]
Degrade the sound quality. The sound quality will become poorer as this value is increased.

Post Filter (Post Filter Type) 1 - 6 [3]
Specify the type of filter that will be applied after the sound passes through the Lo-Fi effect.

+Balance (Effect Balance) D > 0E - D 0<E [16]
Adjust the volume balance between the direct and the processed sound.
"D" or "E" on the display respectively means D(direct sound) or E(effect sound) values of 100.

Low Gain -12 - +12 [17]
Adjust the gain of the low frequency range.

Hi Gain (High gain) -12 - +12 [18]
Adjust the gain of the high frequency range.

#Pan (Output pan) L63 - 0 - R63 [19]
Adjust the stereo location of the output sound. L63 is far left, 0 is center, and R63 is far right.

Level (Output level) 0 - 127 [20]
Adjust the output level.

34: Lo-Fi 2 [01H, 73H]

Lo-Fi 2 is an effect that intentionally degrades the sound quality and allows a variety of noise to be added

* If the R.Detune (Radio Detune), W/P Level (White/Pink Noise Level), Disc Nz Lev (Disc Noise Level), or Hum Level settings are raised, there will be noise even when the input sound is silent.

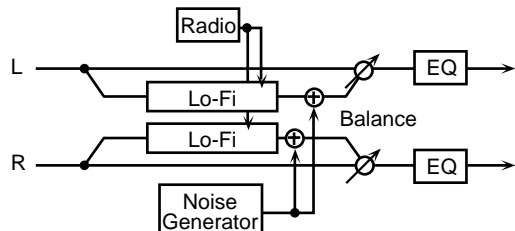

Lo-Fi Type 1 - 6 [1]
Degrade the sound quality. The sound quality will become poorer as this value is increased.

Filter Type (Filter Type) Off/LPF/HPF [2]
Specify the type of filter that is applied after the sound passes through the Lo-Fi effect.

Cutoff (Cutoff Frequency) 250 - 8 k [3]
Specify the cutoff frequency of the filter that is applied after the sound passes through the Lo-Fi effect.

+R.Detune (Radio Detune) 0 - 127 [4]
This simulates the tuning noise of a radio. As this value is raised, the tuning will drift further.

R.Nz Lev (Radio Noise Level) 0 - 127 [5]
Adjust the volume of the radio noise.

W/P Sel (White/Pink Noise Select) White/Pink [6]
Select either white noise or pink noise.

W/P LPF (White/Pink Noise LPF)
250 - 6.3 k/Bypass [7]
Specify the cutoff frequency of the low pass filter that is applied to the white noise or pink noise.

W/P Level (White/Pink Noise Level) 0 - 127 [8]
Specify the volume of the white noise or pink noise.

Disc Type (Disc Noise Type) LP/EP/SP/RND [9]
Select the type of record noise. The frequency at which the noise is heard will depend on the selected type.

Disc LPF (Disc Noise LPF)
250 - 6.3 k/Bypass [10]
Specify the cutoff frequency of the low pass filter that is applied to the record noise.

Disc Nz Lev (Disc Noise Level) 0 - 127 [11]
Specify the volume of the record noise.

Hum Type (Hum Noise Type) 50/60 Hz [12]
Select the type of hum noise.

Hum LPF (Hum Noise LPF)
250 - 6.3 k/Bypass [13]
Specify the cutoff frequency of the low pass filter that is applied to the hum noise.

Hum Level (Hum Noise Level) 0 - 127 [14]
Specify the volume of the hum noise.

M/S (Mono/Stereo Switch) Mono/Stereo [15]
Select whether the effect sound will be monaural or stereo.

#Balance (Effect Balance) D>0E - D0 - 0<E [16]
Adjust the volume balance between the direct and the effect sound.
“D” or “E” on the display respectively means D(direct sound) or E(effect sound) values of 100.

Low Gain -12 - +12 [17]
Adjust the gain of the low frequency range.

Hi Gain (High gain) -12 - +12 [18]
Adjust the gain of the high frequency range.

Pan (Mono) (Output Pan (Mono))
L63 - 0 - R63 [19]
When Mono mode is used, adjust the stereo location of the output sound. L63 is far left, 0 is center, and R63 is far right.

Level (Output level) 0 - 127 [20]
Adjust the output level.

○ **Effects that connect two types of effect in series (series 2)**

35: OD → Chorus (Overdrive → Chorus)
[02H, 00H]

This effect connects an overdrive and a chorus in series.

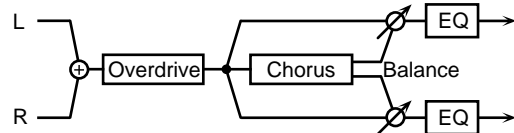

OD Drive (Overdrive drive) 0 - 127 [1]
Adjust the degree of overdrive distortion. The volume will change together with the degree of distortion.

+OD Pan (Overdrive drive output pan)
L63 - 0 - R63 [2]
Adjust the stereo location of the overdrive sound. L63 is far left, 0 is center, and R63 is far right.

OD Amp (Overdrive Amp Simulator Type)
Small/BitIn/2-Stk/3-Stk [3]
Select the type of guitar amp.
Small : small amp
BitIn : single-unit type amp
2-Stk : large double stack amp
3-Stk : large triple stack amp

OD Amp Sw (Overdrive Amp switch) Off/On [4]
Turn OD Amp on/off.

Cho Dly (Chorus pre delay) 0 - 100m [6]
Adjust the time delay from when the direct sound begins until the chorus sound is heard.

Cho Rate (Chorus rate) 0.05 - 10.0 [7]
Adjust the modulation speed of the chorus effect.

Cho Depth (Chorus depth) 0 - 127 [8]
Adjust the modulation depth of the chorus effect.

#Cho Bal (Chorus balance) D>0E - D0<E [10]
Adjust the volume balance between the sound which passes through the chorus and the sound which does not. With a setting of D>0E, only the overdrive sound will be output, and with a setting of D0<E, the overdrive sound which passes through the chorus will be output. “D” and “E” respectively indicate D (dry sound) and E (effect sound) values of 100.

Low Gain -12 - +12 [17]
Adjust the low frequency gain.

Hi Gain (High gain) -12 - +12 [18]
Adjust the high frequency gain.

Level (Output level) 0 - 127 [20]
Adjust the output level.

Hi Gain (High gain) -12 - +12 [18]
Adjust the high frequency gain.

Level (Output level) 0 - 127 [20]
Adjust the output level.

36: OD → Flanger (Overdrive → Flanger) [02H, 01H]

This effect connects an overdrive and a flanger in series.

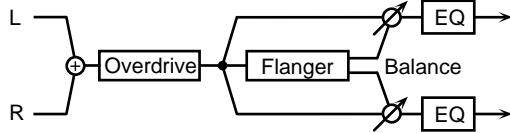

OD Drive (Overdrive drive) 0 - 127 [1]
Adjust the degree of overdrive distortion. The volume will change together with the degree of distortion.

+OD Pan (Overdrive output pan) L63 - 0 - R63 [2]
Adjust the stereo location of the overdrive sound. L6 is far left, 0 is center, and R63 is far right.

OD Amp (Overdrive Amp Simulator Type) Small/BitIn/2-Stk/3-Stk [3]
Select the type of guitar amp.

- Small** : small amp
- BitIn** : single-unit type amp
- 2-Stk** : large double stack amp
- 3-Stk** : large triple stack amp

OD Amp Sw (Overdrive Amp Switch) Off/On [4]
Turn OD Amp on/off.

FL Dly (Flanger pre delay) 0 - 100m [6]
Adjust the time delay from when the direct sound begins until the flanger sound is heard.

FL Rate (Flanger rate) 0.05 - 10.0 [7]
Adjust the modulation speed of the flanger effect.

FL Depth (Flanger depth) 0 - 127 [8]
Adjust the modulation depth of the flanger effect.

FL Fb (Flanger feedback level) -98% - +98% [9]
Adjust the proportion (%) of the flanger sound that is fed back into the effect. Negative (-) settings will invert the phase.

#FL Bal (Flanger balance) D> 0E - D 0<E [10]
Adjust the volume balance between the sound which passes through the flanger and the sound which does not. With a setting of D>0E, only the overdrive sound will be output, and with a setting of D 0<E, the overdrive sound which passes through the flanger will be output. “D” and “E” respectively indicate D (dry sound) and E (effect sound) values of 100.

Low Gain -12 - +12 [17]
Adjust the low frequency gain.

37: OD → Delay (Overdrive → Delay) [02H, 02H]

This effect connects an overdrive and a delay in series.

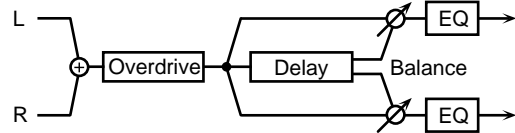

OD Drive (Overdrive drive) 0 - 127 [1]
Adjust the degree of overdrive distortion. The volume will change together with the degree of distortion.

+OD Pan (Overdrive output pan) L63 - 0 - R63 [2]
Adjust the stereo location of the overdrive sound. L63 is far left, 0 is center, and R63 is far right.

OD Amp (Overdrive Amp Simulator Type) Small/BitIn/2-Stk/3-Stk [3]
Select the type of guitar amp.

- Small** : small amp
- BitIn** : single-unit type amp
- 2-Stk** : large double stack amp
- 3-Stk** : large triple stack amp

OD Amp Sw (Overdrive Amp Switch) Off/On [4]
Turn OD Amp on/off.

Dly Time (Delay time) 0 - 500m [6]
Adjust the time delay from when the direct sound begins until the delay sound is heard.

Dly Fb (Delay feedback level) -98% - +98% [7]
Adjust the proportion (%) of the delay sound that is fed back into the effect. Negative (-) settings will invert the phase.

Dly HF (Delay HF damp) 315 - 8k/Bypass [8]
Adjust the frequency above which delayed sound fed back to the effect will be cut. If you do not wish to cut the high frequencies of the feedback, set this parameter to Bypass.

#Dly Bal (Delay balance) D> 0E - D 0<E [10]
Adjust the volume balance between the sound which passes through the delay and the sound which does not. With a setting of D>0E, only the overdrive sound will be output, and with a setting of D 0<E, the overdrive sound which passes through the delay will be output. “D” or “E” on the display respectively means D(direct sound) or E(effect sound) values of 100.

Low Gain -12 - +12 [17]
Adjust the low frequency gain.

Hi Gain (High gain) -12 - +12 [18]
Adjust the high frequency gain.

Level (Output level) 0 - 127 [20]
Adjust the output level.

Low Gain -12 - +12 [17]
Adjust the low frequency gain.

Hi Gain (High gain) -12 - +12 [18]
Adjust the high frequency gain.

Level (Output level) 0 - 127 [20]
Adjust the output level.

38: DS → Chorus (Distortion → Chorus)
[02H, 03H]

This effect connects a distortion and a chorus in series.

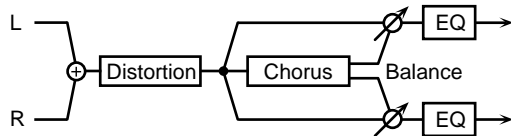

DS Drive (Distortion drive) 0 - 127 [1]
Adjust the degree of distortion. The volume will change together with the degree of distortion.

+DS Pan (Distortion output pan)
L63 - 0 - R63 [2]
Adjust the stereo location of the distortion sound. L63 is far left, 0 is center, and R63 is far right.

DS Amp (Distortion Amp Simulator Type)
Small/Bltn/2-Stk/3-Stk [3]
Select the type of guitar amp.

- Small** : small amp
- Bltn** : single-unit type amp
- 2-Stk** : large double stack amp
- 3-Stk** : large triple stack amp

DS Amp Sw (Distortion Amp Switch) Off/On [4]
Turn DS Amp on/off.

Cho Dly (Chorus pre delay) 0 - 100m [6]
Adjust the time delay from when the direct sound begins until the chorus sound is heard.

Cho Rate (Chorus rate) 0.05 - 10.0 [7]
Adjust the modulation speed of the chorus effect.

Cho Depth (Chorus depth) 0 - 127 [8]
Adjust the modulation depth of the chorus effect.

#Cho Bal (Chorus balance) D> 0E - D 0<E [10]
Adjust the volume balance between the sound which passes through the chorus and the sound which does not. With a setting of D>0E, only the distortion sound will be output, and with a setting of D 0<E, the distortion sound which passes through the chorus will be output.

"D" or "E" on the display respectively means D(direct sound) or E(effect sound) values of 100.

39: DS → Flanger (Distortion → Flanger)
[02H, 04H]

This effect connects a distortion and a flanger in series.

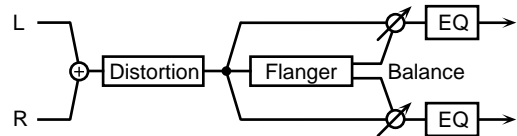

DS Drive (Distortion drive) 0 - 127 [1]
Adjust the degree of distortion. The volume will change together with the degree of distortion.

+DS Pan (Distortion output pan)
L63 - 0 - R63 [2]
Adjust the stereo location of the distortion sound. L63 is far left, 0 is center, and R63 is far right.

DS Amp (Distortion Amp Simulator Type)
Small/Bltn/2-Stk/3-Stk [3]
Select the type of guitar amp.

- Small** : small amp
- Bltn** : single-unit type amp
- 2-Stk** : large double stack amp
- 3-Stk** : large triple stack amp

DS Amp Sw (Distortion Amp Switch) Off/On [4]
Turn DS Amp on/off.

FL Dly (Flanger pre delay) 0 - 100m [6]
Adjust the time delay from when the direct sound begins until the flanger sound is heard.

FL Rate (Flanger rate) 0.05 - 10.0 [7]
Adjust the modulation speed of the flanger effect.

FL Depth (Flanger depth) 0 - 127 [8]
Adjust the modulation depth of the flanger effect.

FL Fb (Flanger feedback level) -98% - +98% [9]
Adjust the proportion (%) of the flanger sound that is fed back into the effect. Negative (-) settings will invert the phase.

#FL Bal (Flanger balance) $D > 0E - D < 0 < E$ [10]

Adjust the volume balance between the sound which passes through the flanger and the sound which does not. With a setting of $D > 0E$, only the distortion sound will be output, and with a setting of $D < 0 < E$, the distortion sound which passes through the flanger will be output.

“D” or “E” on the display respectively means D(direct sound) or E(effect sound) values of 100.

Low Gain -12 - +12 [17]
Adjust the low frequency gain.

Hi Gain (High gain) -12 - +12 [18]
Adjust the high frequency gain.

Level (Output level) 0 - 127 [20]
Adjust the output level.

#Dly Bal (Delay balance) $D > 0E - D < 0 < E$ [10]

Adjust the volume balance between the sound which passes through the delay and the sound which does not. With a setting of $D > 0E$, only the distortion sound will be output, and with a setting of $D < 0 < E$, the distortion sound which passes through the delay will be output. “D” and “E” respectively indicate D (dry sound) and E (effect sound) values of 100.

Low Gain -12 - +12 [17]
Adjust the low frequency gain.

Hi Gain (High gain) -12 - +12 [18]
Adjust the high frequency gain.

Level (Output level) 0 - 127 [20]
Adjust the output level.

40: DS → Delay (Distortion → Delay) [02H, 05H]

This effect connects a distortion and a delay in series.

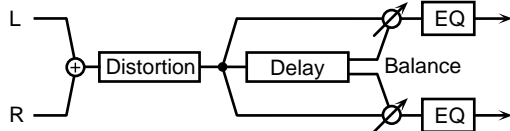

DS Drive (Distortion drive) 0 - 127 [1]
Adjust the degree of distortion. The volume will change together with the degree of distortion.

+DS Pan (Distortion output pan) L63 - 0 - R63 [2]
Adjust the stereo location of the distortion sound. L63 is far left, 0 is center, and R63 is far right.

DS Amp (Distortion Amp Simulator Type) Small/Bltn/2-Stk/3-Stk [3]
Select the type of guitar amp.
Small : small amp
Bltn : single-unit type amp
2-Stk : large double stack amp
3-Stk : large triple stack amp

DS Amp Sw (Distortion Amp Switch) Off/On [4]
Turn DS Amp on/off.

Dly Time (Delay time) 0 - 500m [6]
Adjust the time delay from when the direct sound begins until the delay sound is heard.

Dly Fb (Delay feedback level) -98% - +98% [7]
Adjust the proportion (%) of the delay sound that is fed back into the effect. Negative (-) settings will invert the phase.

Dly HF (Delay HF damp) 315 - 8k/Bypass [8]
Adjust the frequency above which delayed sound fed back to the effect will be cut. If you do not wish to cut the high frequencies of the feedback, set this parameter to Bypass.

41: EH → Chorus (Enhancer → Chorus) [02H, 06H]

This effect connects an enhancer and a chorus in series.

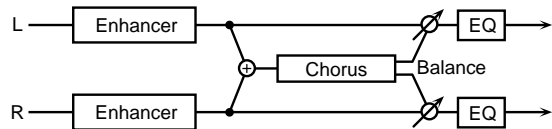

+EH Sens (Enhancer Sensitivity) 0 - 127 [1]
Adjust the sensitivity of the enhancer.

EH Mix (Enhancer Mix level) 0 - 127 [2]
Adjust the ratio with which the overtones generated by the enhancer are combined with the direct sound.

Cho Dly (Chorus pre delay) 0 - 100m [6]
Adjust the time delay from when the direct sound begins until the chorus sound is heard.

Cho Rate (Chorus rate) 0.05 - 10.0 [7]
Adjust the modulation speed of the chorus effect.

Cho Depth (Chorus depth) 0 - 127 [8]
Adjust the modulation depth of the chorus effect.

#Cho Bal (Chorus balance) $D > 0E - D < 0 < E$ [10]

Adjust the volume balance between the sound which passes through the chorus and the sound which does not. With a setting of $D > 0E$, only the enhancer sound will be output, and with a setting of $D < 0 < E$, the enhancer sound which passes through the chorus will be output.

“D” or “E” on the display respectively means D(direct sound) or E(effect sound) values of 100.

Low Gain -12 - +12 [17]
Adjust the low frequency gain.

Hi Gain (High gain) -12 - +12 [18]
Adjust the high frequency gain.

Level (Output level) 0 - 127 [20]
Adjust the output level.

42: EH → Flanger (Enhancer → Flanger) [02H, 07H]

This effect connects an enhancer and a flanger in series.

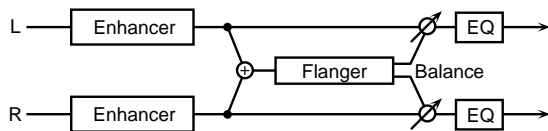

+EH Sens (Enhancer Sensitivity) 0 - 127 [1]
Adjust the sensitivity of the enhancer.

EH Mix (Enhancer Mix level) 0 - 127 [2]
Adjust the ratio with which the overtones generated by the enhancer are combined with the direct sound.

FL Dly (Flanger pre delay) 0 - 100m [6]
Adjust the time delay from when the direct sound begins until the flanger sound is heard.

FL Rate (Flanger rate) 0.05 - 10.0 [7]
Adjust the modulation speed of the flanger effect.

FL Depth (Flanger depth) 0 - 127 [8]
Adjust the modulation depth of the flanger effect.

FL Fb (Flanger Feedback level) -98% - +98% [9]
Adjust the proportion (%) of the flanger sound that is fed back into the effect. Negative (-) settings will invert the phase.

#FL Bal (Flanger balance) D > 0E - D 0 < E [10]
Adjust the volume balance between the sound which passes through the flanger and the sound which does not. With a setting of D > 0E, only the enhancer sound will be output, and with a setting of D 0 < E, the enhancer sound which passes through the flanger will be output. "D" and "E" respectively indicate D (dry sound) and E (effect sound) values of 100.

Low Gain -12 - +12 [17]
Adjust the low frequency gain.

Hi Gain (High gain) -12 - +12 [18]
Adjust the high frequency gain.

Level (Output level) 0 - 127 [20]
Adjust the output level.

43: EH → Delay (Enhancer → Delay) [02H, 08H]

This effect connects an enhancer and a delay in series.

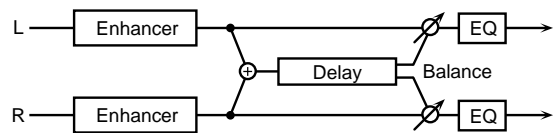

+EH Sens (Enhancer Sensitivity) 0 - 127 [1]
Adjust the sensitivity of the enhancer.

EH Mix (Enhancer Mix level) 0 - 127 [2]
Adjust the ratio with which the overtones generated by the enhancer are combined with the direct sound.

Dly Time (Delay time) 0 - 500m [6]
Adjust the time delay from when the direct sound begins until the delay sound is heard.

Dly Fb (Delay feedback level) -98% - +98% [7]
Adjust the proportion (%) of the delay sound that is fed back into the delay input. Negative (-) settings will invert the phase.

Dly HF (Delay HF damp) 315 - 8k/Bypass [8]
Adjust the frequency above which delayed sound fed back to the delay input will be cut. If you do not wish to cut the high frequencies of the delay feedback, set this parameter to Bypass.

#Dly Bal (Delay balance) D > 0E - D 0 < E [10]
Adjust the volume balance between the sound which passes through the delay and the sound which does not. With a setting of D > 0E, only the enhancer sound will be output, and with a setting of D 0 < E, the enhancer sound which passes through the delay will be output.
"D" or "E" on the display respectively means D(direct sound) or E(effect sound) values of 100.

Low Gain -12 - +12 [17]
Adjust the low frequency gain.

Hi Gain (High gain) -12 - +12 [18]
Adjust the high frequency gain.

Level (Output level) 0 - 127 [20]
Adjust the output level.

44: Cho → Delay (Chorus → Delay) [02H, 09H]

This effect connects a chorus and a delay unit in series.

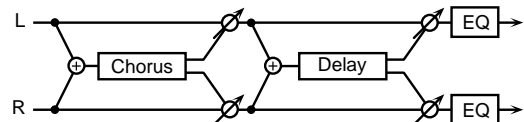

Cho Dly (Chorus pre delay) 0 - 100m [1]
Adjust the time delay from when the direct sound begins until the chorus sound is heard.

Cho Rate (Chorus rate) 0.05 - 10.0 [2]
Adjust the modulation speed of the chorus effect.

Cho Depth (Chorus depth) 0 - 127 [3]
Adjust the modulation depth of the chorus effect.

+Cho Bal (Chorus balance) $D > 0E - D 0 < E$ [5]
Adjust the volume balance between the direct sound and the chorus sound. With a setting of " $D > 0E$," only the direct sound will be output. With a setting of " $D 0 < E$," only the chorus sound will be output.
"D" or "E" on the display respectively means D(direct sound) or E(effect sound) values of 100.

Dly Time (Delay time) 0 - 500m [6]
Adjust the time delay from when the direct sound begins until the delay sound is heard.

Dly Fb (Delay feedback level) -98% - +98% [7]
Adjust the proportion (%) of the delay sound that is fed back into the delay input. Negative (-) settings will invert the phase.

Dly HF (Delay HF damp) 315 - 8k/Bypass [8]
Adjust the frequency above which delayed sound fed back to the delay input will be cut. If you do not wish to cut the high frequencies of the feedback, set this parameter to Bypass.

#Dly Bal (Delay balance) $D > 0E - D 0 < E$ [10]
Adjust the volume balance between the sound which passes through the delay and the sound which does not. With a setting of $D > 0E$, only the chorus sound will be output, and with a setting of $D 0 < E$, the chorus sound which passes through the delay will be output.
"D" or "E" on the display respectively means D(direct sound) or E(effect sound) values of 100.

Low Gain -12 - +12 [17]
Adjust the low frequency gain.

Hi Gain (High gain) -12 - +12 [18]
Adjust the high frequency gain.

Level (Output level) 0 - 127 [20]
Adjust the output level.

45: FL → Delay (Flanger → Delay) [02H, 0AH]

This effect connects a flanger and a delay in series.

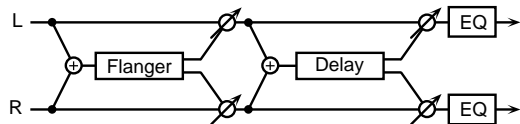

FL Dly (Flanger pre delay) 0 - 100m [1]
Adjust the time delay from when the direct sound begins until the flanger sound is heard.

FL Rate (Flanger rate) 0.05 - 10.0 [2]
Adjust the modulation speed of the flanger effect.

FL Depth (Flanger depth) 0 - 127 [3]
Adjust the modulation depth of the flanger effect.

+FL Fb (Flanger feedback level) -98% - +98% [4]
Adjust the proportion (%) of the flanger sound that is fed back into the effect. Negative (-) settings will invert the phase.

FL Bal (Flanger balance) $D > 0E - D 0 < E$ [5]
Adjust the volume balance between the direct sound and the flanger sound. With a setting of " $D > 0E$," only the direct sound will be output. With a setting of " $D 0 < E$," only the flanger sound will be output.
"D" or "E" on the display respectively means D(direct sound) or E(effect sound) values of 100.

Dly Time (Delay time) 0 - 500m [6]
Adjust the time delay from when the direct sound begins until the delay sound is heard.

Dly Fb (Delay feedback level) -98% - +98% [7]
Adjust the proportion (%) of the delay sound that is fed back into the delay input. Negative (-) settings will invert the phase.

Dly HF (Delay HF damp) 315 - 8k/Bypass [8]
Adjust the frequency above which delayed sound fed back to the delay input will be cut. If you do not wish to cut the high frequencies of the delay feedback, set this parameter to Bypass.

#Dly Bal (Delay balance) $D > 0E - D 0 < E$ [10]
Adjust the volume balance between the sound which passes through the delay and the sound which does not. With a setting of $D > 0E$, only the flanger sound will be output, and with a setting of $D 0 < E$, the flanger sound which passes through the delay will be output.
"D" or "E" on the display respectively means D(direct sound) or E(effect sound) values of 100.

Low Gain -12 - +12 [17]
Adjust the low frequency gain.

Hi Gain (High gain) -12 - +12 [18]
Adjust the high frequency gain.

Level (Output level) 0 - 127 [20]
Adjust the output level.

46: Cho → Flanger (Chorus → Flanger) [02H, 0BH]

This effect connects a chorus and a flanger in series.

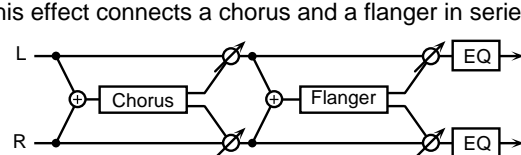

Cho Dly (Chorus pre delay) 0 - 100m [1]
Adjust the time delay from when the direct sound begins until the chorus sound is heard.

Cho Rate (Chorus rate) 0.05 - 10.0 [2]
Adjust the modulation speed of the chorus effect.

Cho Depth (Chorus depth) 0 - 127 [3]
Adjust the modulation depth of the chorus effect.

+Cho Bal (Chorus balance) D> 0E - D 0<E [5]
Adjust the volume balance between the direct sound and the chorus sound. With a setting of "D> 0E," only the direct sound will be output. With a setting of "D 0<E," only the chorus sound will be output.

"D" or "E" on the display respectively means D(direct sound) or E(effect sound) values of 100.

FL Dly (Flanger pre delay time) 0 - 100m [6]
Adjust the time delay from when the direct sound begins until the flanger sound is heard.

FL Rate (Flanger rate) 0.05 - 10.0 [7]
Adjust the modulation speed of the flanger effect.

FL Depth (Flanger depth) 0 - 127 [8]
Adjust the modulation depth of the flanger effect.

FL Fb (Flanger feedback level) -98% - +98% [9]
Adjust the proportion (%) of the flanger sound that is fed back into the effect. Negative (-) settings will invert the phase.

#FL Bal (Flanger balance) D> 0E - D 0<E [10]
Adjust the volume balance between the sound which passes through the flanger and the sound which does not. With a setting of D>0E, only the chorus sound will be output, and with a setting of D 0<E, the chorus sound which passes through the flanger will be output.

"D" or "E" on the display respectively means D(direct sound) or E(effect sound) values of 100.

Low Gain -12 - +12 [17]
Adjust the low frequency gain.

Hi Gain (High gain) -12 - +12 [18]
Adjust the high frequency gain.

Level (Output level) 0 - 127 [20]
Adjust the output level.

○ **Effects that connect three or more types of effect in series (series 3 / series 4 / series 5)**

47: Rotary Multi [03H, 00H]

This connects Overdrive (OD), 3-band equalizer (EQ), and Rotary (RT) effects in series.

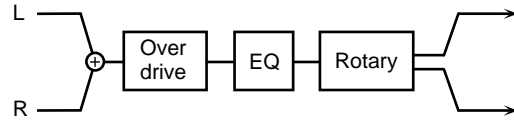

+OD Drive 0 - 127 [1]
Adjust the depth of distortion. The volume will change together with the depth of distortion.

OD Sw (Overdrive Switch) Off/On [2]
Turn the Overdrive effect on/off.

EQ L Gain (EQ Low Gain) -12 - +12 [3]
Adjust the low range gain of the equalizer.

EQ M Fq (EQ Mid Frequency) 200 - 6.3k [4]
Set the center frequency for the equalizer mid-range.

EQ M Q (EQ Mid Q) 0.5/1.0/2.0/4.0/9.0 [5]
Adjust the width of the area centered at the EQ M Fq setting in which the gain will be affected. The area affected will become narrower as this value is increased.

EQ M Gain (EQ Mid Gain) -12 - +12 [6]
Adjust the gain of the area specified by the EQ M Fq parameter and the EQ M Q parameter.

EQ H Gain (EQ High Gain) -12 - +12 [7]
Adjust the high-range gain of the equalizer.

<RT (Rotary)>

RT L Slow (RT Low Frequency Slow Rate) 0.05 - 10.0 [8]
Adjust the speed of the low-range rotor for the low-speed (Slow) setting.

RT L Fast (RT Low Frequency Fast Rate) 0.05 - 10.0 [9]
Adjust the speed of the low-range rotor for the high-speed (Fast) setting.

RT Lo Accl (RT Low Frequency Acceleration) 0 - 15 [10]
Adjust the time over which the rotation speed of the low-range rotor will change from low-speed to high-speed (or high-speed to low-speed) rotation. Smaller values will require greater time to reach the new rotational speed.

RT Lo Lev (RT Low Frequency Level) 0 - 127 [11]
Adjust the volume of the low-range rotor.

RT H Slow (RT High Frequency Slow Rate) 0.05 - 10.0 [12]
Adjust the speed of the high-range rotor for the low-speed (Slow) setting.

RT H Fast (RTRT High Frequency Fast Rate) 0.05 - 10.0 [13]
Adjust the speed of the high-range rotor for the high-speed (Fast) setting.

RT Hi Accl (RT High Frequency Acceleration) 0 - 15 [14]
Adjust the time over which the rotation speed of the high-range rotor will change from low-speed to high-speed (or high-speed to low-speed) rotation. Smaller values will require greater time to reach the new rotational speed.

RT Hi Lev (RT High Frequency Level) 0 - 127 [15]
Adjust the volume of the high-range rotor.

RT Sept (RT Separation) 0 - 127 [16]
Adjust the spatial spread of the rotary sound.

#RT Speed Slow/Fast [17]
Simultaneously switch the rotational speed of both the low-range and the high-range rotors.
Slow : Slow down the rotation to the specified speeds (RT L Slow parameter / RT H Slow parameter values).
Fast : Speed up the rotation to the specified speeds (RT L Fast parameter / RT H Fast parameter values).

Level (Output level) 0 - 127 [20]
Adjust the output level.

48: GTR Multi 1 (Guitar Multi1) [04H, 00H]
Guitar Multi 1 connects Compressor (Cmp), Overdrive or Distortion (OD), Chorus or Flanger (CF), and Delay (Dly) effects in series.

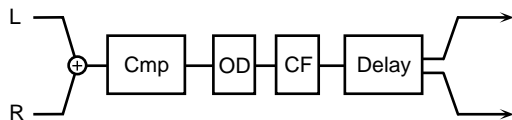

<Cmp (Compressor)>

Cmp Atck (Compressor Attack) 0 - 127 [1]
Adjust the time over which the sound will rise after input.

Cmp Sus (Compressor Sustain) 0 - 127 [2]
Adjust the time over which low-level sounds are boosted until they reach a specified volume. Increasing the value will shorten the time. When the value is modified, the level will also change.

Cmp Level (Compressor Level) 0 - 127 [3]
Adjust the volume of the compressor sound.

Cmp Sw (Compressor Switch) Off/On [4]
Turn the compressor on/off.

<OD (Overdrive/Distortion)>

OD Sel (OD Select) Odrv/Dist [5]
Select either Overdrive or Distortion.

+OD Drive 0 - 127 [6]
Adjust the depth of distortion. The volume will change together with the depth of distortion.

OD Amp (OD Amp Simulator Type) Small/Bltn/2-Stk/3-Stk [7]
Select the type of guitar amp.
Small : small amp
Bltn : single-unit type amp
2-Stk : large double stack amp
3-Stk : large triple stack amp

OD Amp Sw (OD Amp Switch) Off/On [8]
Turn OD Amp on/off.

OD L Gain (OD Low Gain) -12 - +12 [9]
Adjust the low-range gain.

OD H Gain (OD High Gain) -12 - +12 [10]
Adjust the high-range gain.

OD Sw (OD Switch) Off/On [11]
Turn Overdrive or Distortion on/off.

<CF (Chorus/Flanger)>

CF Sel (CF Select) Chorus/Flangr [12]
Select either Chorus or Flanger.

CF Rate 0.05 - 6.40 [13]
Adjust the speed of modulation

CF Depth 0 - 127 [14]
Adjust the depth of modulation.

CF Fb (CF Feedback) -98% - +98% [15]
Adjust the amount (%) of the flanger sound that is returned to the input. Negative (-) values will invert the phase.
In the case of Chorus, this will have no effect.

CF Mix 0 - 127 [16]
Adjust the volume of the chorus or flanger sound.

<Dly(Delay)>

Dly Time (Delay Time) 0m - 635m [17]
Adjust the time from the original sound until when the delay sound is heard.

Dly Fb (Delay Feedback Level) 0 - 127 [18]
Adjust the amount of the delay sound that is returned to the input.

#Dly Mix (Delay Mix) 0 - 127 [19]
Adjust the volume of the delay sound.

Level (Output level) 0 - 127 [20]
Adjust the output level.

49: GTR Multi 2 (Guitar Multi2) [04H, 01H]

Guitar Multi 2 provides Compressor (Cmp), Overdrive or Distortion (OD), Equalizer (EQ), and Chorus or Flanger (CF) effects connected in series.

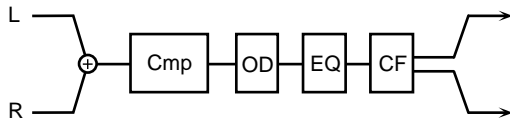

<Cmp (Compressor)>

Cmp Atck (Compressor Attack) 0 - 127 [1]
Adjust the time over which the sound will rise after it is input.

Cmp Sus (Compressor Sustain) 0 - 127 [2]
Adjust the time over which low-level sounds are boosted until they reach a specified volume.
Increasing the value will shorten the time. When the value is modified, the level will also change.

Cmp Level (Compressor Level) 0 - 127 [3]
Adjust the volume of the compressor sound.

Cmp Sw (Compressor Switch) Off/On [4]
Turn the compressor on/off.

<OD (Overdrive/Distortion)>

OD Sel (OD Select) Odrv/Dist [5]
Select either Overdrive or Distortion.

+OD Drive (OD Drive) 0 - 127 [6]
Adjust the depth of distortion. The volume will change together with the depth of distortion.

OD Amp (OD Amp Simulator Type)
Small/Bltn/2-Stk/3-Stk [7]

Select the type of guitar amp

- Small** : small amp
- Bltn** : single-unit type amp
- 2-Stk** : large double stack amp
- 3-Stk** : large triple stack amp

OD Amp Sw (OD Amp Switch) Off/On [8]
Turn OD Amp on/off.

OD Sw (OD Switch) Off/On [9]
Turn Overdrive or Distortion on/off.

<EQ (Equalizer)>

EQ L Gain (EQ Low Gain) -12 - +12 [10]
Adjust the low-range gain of the equalizer.

EQ M Fq (EQ Mid Frequency) 200 - 6.3k [11]
Set the center frequency for the equalizer mid-range.

EQ M Q (EQ Mid Q) 0.5/1.0/2.0/4.0/9.0 [12]
Adjust the width of the area centered at the EQ M Fq setting in which the gain will be affected. The area affected will become narrower as this value is increased.

EQ M Gain (EQ Mid Gain) -12 - +12 [13]
Adjust the gain of the area specified by the EQ M Fq parameter and the EQ M Q parameter.

EQ H Gain (EQ High Gain) -12 - +12 [14]
Adjust the high-range gain of the equalizer.

<CF (Chorus/Flanger)>

CF Sel (CF Select) Chorus/Flangr [15]
Select either Chorus or Flanger.

CF Rate 0.05 - 6.40 [16]
Adjust the speed of modulation for the chorus or flanger.

CF Depth 0 - 127 [17]
Adjust the depth of modulation for the chorus or flanger.

CF Fb (CF Feedback) -98% - +98% [18]
Adjust the amount (%) of the flanger sound that will be returned to the input. Negative (-) values will invert the phase.

In the case of Chorus, this will have no effect.

#CF Mix (CF Mix) 0 - 127 [19]
Adjust the volume of the chorus or flanger sound.

Level (Output level) 0 - 127 [20]
Adjust the output level.

50: GTR Multi 3 (Guitar Multi3) [04H, 02H]

Guitar Multi 3 connects Wah (Wah), Overdrive or Distortion (OD), Chorus or Flanger (CF), and Delay (Dly) effects in series.

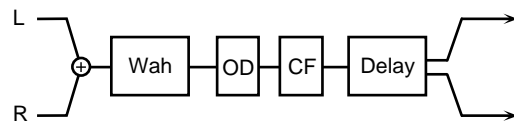

<Wah>

Wah Fil (Wah Filter Type) LPF/BPF [1]
Select the type of filter.

LPF : The wah effect will be produced over a broad frequency range.

BPF : The wah effect will be produced in a narrow frequency range.

+Wah Man (Wah Manual) 0 - 127 [2]
Set the center frequency at which the effect will be produced.

Wah Peak 0 - 127 [3]
Adjust the way in which the wah effect will be applied to the region of the center frequency. Lower settings will produce a wah effect in a broad area around the center frequency, and higher settings will produce a wah effect in a narrower area around the center frequency.

Wah Sw (Wah Switch) Off/On [4]
Turn Wah on/off.

<OD (Overdrive/Distortion)>

OD Sel (OD Select) Odrv/Dist [5]
Select either Overdrive or Distortion.

#OD Drive 0 - 127 [6]
Adjust the depth of distortion. The volume will change together with the depth of distortion.

OD Amp (OD Amp Simulator Type) Small/Bltn/2-Stk/3-Stk [7]
Select the type of guitar amp

- Small** : small amp
- Bltn** : single-unit type amp
- 2-Stk** : large double stack amp
- 3-Stk** : large triple stack amp

OD Amp Sw (OD Amp Switch) Off/On [8]
Turn OD Amp on/off.

OD L Gain (OD Low Gain) -12 - +12 [9]
Adjust the low-range gain for the overdrive (or distortion) sound.

OD H Gain (OD High Gain) -12 - +12 [10]
Adjust the high-range gain for the overdrive (or distortion) sound.

OD Sw (OD Switch) Off/On [11]
Turn overdrive or distortion on/off.

<CF (Chorus/Flanger)>

CF Sel (CF Select) Chorus/Flangr [12]
Select either Chorus or Flanger.

CF Rate 0.05 - 6.40 [13]
Adjust the modulation speed for the chorus or flanger.

CF Depth 0 - 127 [14]
Adjust the modulation depth for the chorus or flanger.

CF Fb (CF Feedback) -98% - +98% [15]
Adjust the amount (%) of the flanger sound that is returned to the input. Negative (-) values will invert the phase.

In the case of Chorus, this will have no effect.

CF Mix 0 - 127 [16]
Adjust the volume of the chorus or flanger sound.

<Dly (Delay)>

Dly Time (Delay Time) 0m - 635m [17]
Adjust the time from the original sound until when the delay sound is heard.

Dly Fb (Delay Feedback Level) 0 - 127 [18]
Adjust the amount of the delay sound that is returned to the input.

Dly Mix (Delay Mix) 0 - 127 [19]
Adjust the volume of the delay sound.

Level (Output level) 0 - 127 [20]
Adjust the output level.

51: Clean Gt Multi1 (Clean Guitar Multi1) [04H, 03H]

Clean Guitar Multi 1 connects Compressor (Cmp), Equalizer (EQ), Chorus or Flanger (CF), and Delay (Dly) effects in series.

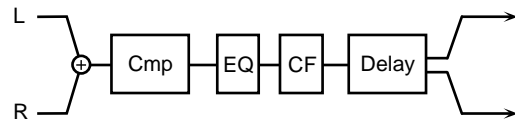

<Cmp (Compressor)>

Cmp Atck (Compressor Attack) 0 - 127 [1]
Adjust the time over which the sound will rise after it is input.

Cmp Sus (Compressor Sustain) 0 - 127 [2]
Adjust the time over which low-level sounds are boosted until they reach a specified volume. Increasing the value will shorten the time. When the value is modified, the level will also change.

Cmp Level (Compressor Level) 0 - 127 [3]
Adjust the volume of the compressor sound.

Cmp Sw (Compressor Switch) Off/On [4]
Turn the compressor on/off.

<EQ (Equalizer)>

EQ L Gain (EQ Low Gain) -12 - +12 [5]
Adjust the low-range gain of the equalizer.

EQ M Fq (EQ Mid Frequency) 200 - 6.3k [6]
Set the center frequency for the equalizer mid-range.

EQ M Q (EQ Mid Q) 0.5/1.0/2.0/4.0/9.0 [7]
Adjust the width of the area centered at the EQ M Fq setting in which the gain will be affected. The area affected will become narrower as this value is increased.

EQ M Gain (EQ Mid Gain) -12 - +12 [8]
Adjust the gain of the area specified by the EQ M Fq parameter and the EQ M Q parameter.

EQ H Gain (EQ High Gain) -12 - +12 [9]
Adjust the high-range gain of the equalizer.

<CF (Chorus/Flanger)>

CF Sel (CF Select) Chorus/Flangr [10]
Select either Chorus or Flanger.

CF Rate 0.05 - 6.40 [11]
Adjust the speed of modulation for the chorus or flanger.

CF Depth 0 - 127 [12]
Adjust the depth of modulation for the chorus or flanger.

CF Fb (CF Feedback) -98% - +98% [13]
Adjust the amount (%) of the flanger sound that will be returned to the input. Negative (-) values will invert the phase.

In the case of Chorus, this will have no effect.

+CF Mix (CF Mix) 0 - 127 [14]
Adjust the volume of the chorus or flanger sound.

<Dly (Delay)>

Dly Time (Delay Time) 0m - 635m [15]
Adjust the time from the original sound until when the delay sound is heard.

Dly Fb (Delay Feedback Level) 0 - 127 [16]
Adjust the amount of the delay sound that is returned to the input.

Dly HF (Delay HF Dump) 315-8k/Bypass[17]
Adjust the frequency at which the high range will be cut from the delay sound that is returned to the input. If you do not wish to cut the high range of the returned sound, select Bypass.

#Dly Mix (Delay Mix) 0 - 127 [18]
Adjust the volume of the delay sound.

Level (Output level) 0 - 127 [20]
Adjust the output level.

<AW (Auto-wah)>

AW Filter (Auto-wah Filter Type) LPF/BPF [1]
Select the type of filter for the auto-wah.

LPF : The wah effect will be produced over a broad frequency range.

BPF : The wah effect will be produced over a narrow frequency range.

+AW Man (Auto-wah Manual) 0 - 127 [2]
Set the center frequency at which the auto-wah effect will be produced.

AW Peak (Auto-wah Peak) 0 - 127 [3]
Adjust the way in which the wah effect will be applied to the region of the center frequency. Lower settings will produce a wah effect in a broad area around the center frequency, and higher settings will produce a wah effect in a narrower area around the center frequency.

AW Rate (Auto-wah Rate) 0.05 - 6.40 [4]
Adjust the modulation speed of the auto-wah.

AW Depth (Auto-wah Depth) 0 - 127 [5]
Adjust the modulation depth of the auto-wah.

AW Sw (Auto-wah Switch) Off/On [6]
Turn Auto-way on/off.

<EQ (Equalizer)>

EQ L Gain (EQ Low Gain) -12 - +12 [7]
Adjust the low-range gain of the equalizer.

EQ M Fq (EQ Mid Frequency) 200 - 6.3k [8]
Set the center frequency for the equalizer mid-range.

EQ M Q (EQ Mid Q) 0.5/1.0/2.0/4.0/9.0 [9]
Adjust the width of the area centered at the EQ M Fq setting in which the gain will be affected. The area affected will become narrower as this value is increased.

EQ M Gain (EQ Mid Gain) -12 - +12 [10]
Adjust the gain of the area specified by the EQ M Fq parameter and the EQ M Q parameter.

EQ H Gain (EQ High Gain) -12 - +12 [11]
Adjust the high-range gain of the equalizer.

<CF (Chorus/Flanger)>

CF Sel (CF Select) Chorus/Flangr [12]
Select either Chorus or Flanger.

CF Rate 0.05 - 6.40 [13]
Adjust the speed of modulation for the chorus or flanger.

52: Clean Gt Multi2 (Clean Guitar Multi2)

[04H, 04H]

Clean Guitar Multi 2 provides Auto-wah (AW), Equalizer (EQ), Chorus or Flanger (CF), and Delay (Dly) effects connected in series.

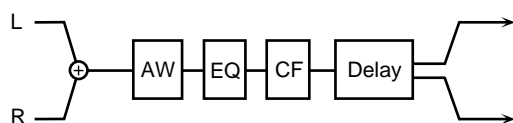

CF Depth 0 - 127 [14]
Adjust the depth of modulation for the chorus or flanger.

CF Fb (CF Feedback) -98% - +98% [15]
Adjust the amount (%) of the flanger sound that will be returned to the input. Negative (-) values will invert the phase.

In the case of Chorus, this will have no effect.

CF Mix 0 - 127 [16]
Adjust the volume of the chorus or flanger sound.

<Dly (Delay)>

Dly Time (Delay Time) 0m - 635m [17]
Adjust the time from the original sound until when the delay sound is heard.

Dly Fb (Delay Feedback Level) 0 - 127 [18]
Adjust the amount of the delay sound that is returned to the input.

#Dly Mix (Delay Mix) 0 - 127 [19]
Adjust the volume of the delay sound.

Level (Output level) 0 - 127 [20]
Adjust the output level.

53: Bass Multi [04H, 05H]

Bass Multi provides Compressor (Cmp), Overdrive or Distortion (OD), Equalizer (EQ), and Chorus or Flanger (CF) effects connected in series.

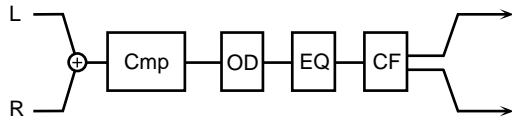

<Cmp (Compressor)>

Cmp Atck (Compressor Attack) 0 - 127 [1]
Adjust the time over which the sound will rise after it is input.

Cmp Sus (Compressor Sustain) 0 - 127 [2]
Adjust the time over which low-level sounds are boosted until they reach a specified volume.

Increasing the value will shorten the time. When the value is modified, the level will also change.

Cmp Level (Compressor Level) 0 - 127 [3]
Adjust the volume of the compressor sound.

Cmp Sw (Compressor Switch) Off/On [4]
Turn the compressor on/off.

<OD (Overdrive/Distortion)>

OD Sel (ODSelect) Odrv/Dist [5]
Select either bass guitar Overdrive or Distortion.

+OD Drive (OD Drive) 0 - 127 [6]
Adjust the depth of distortion. The volume will change together with the depth of distortion.

OD Amp (OD Amp Simulation Type) Small/Bltn/2-Stk [7]

Select the type of guitar amp

- Small** : small amp
- Bltn** : single-unit type amp
- 2-Stk** : large double stack amp

OD Amp Sw (OD Amp Switch) Off/On [8]
Turn OD Amp on/off.

OD Sw (OD Switch) Off/On [9]
Turn Overdrive/Distortion on/off.

<EQ (Equalizer)>

EQ L Gain (EQ Low Gain) -12 - +12 [10]
Adjust the low-range gain of the equalizer.

EQ M Fq (EQ Mid Frequency) 200 - 6.3k [11]
Set the center frequency for the equalizer mid-range.

EQ M Q (EQ Mid Q) 0.5/1.0/2.0/4.0/9.0 [12]
Adjust the width of the area centered at the EQ M Fq setting in which the gain will be affected. The area affected will become narrower as this value is increased.

EQ M Gain (EQ Mid Gain) -12 - +12 [13]
Adjust the gain of the area specified by the EQ M Fq parameter and the EQ M Q parameter.

EQ H Gain (EQ High Gain) -12 - +12 [14]
Adjust the high-range gain of the equalizer.

<CF(Chorus/Flanger)>

CF Sel (CF Select) Chorus/Flangr [15]
Select either Chorus or Flanger.

CF Rate 0.05 - 6.40 [16]
Adjust the speed of modulation for the chorus or flanger.

CF Depth 0 - 127 [17]
Adjust the depth of modulation for the chorus or flanger.

CF Fb (CF Feedback level) -98% - +98% [18]
Adjust the amount (%) of the flanger sound that will be returned to the input. Negative (-) values will invert the phase.

In the case of Chorus, this will have no effect.

#CF Mix 0 - 127 [19]
Adjust the volume of the chorus or flanger sound.

Level (Output level) 0 - 127 [20]
Adjust the output level.

54: Rhodes Multi [04H, 06H]

Rhodes Multi provides Enhancer (EH), Phaser (PH), Chorus or Flanger (CF), and Tremolo or Pan (TP) effects connected in series.

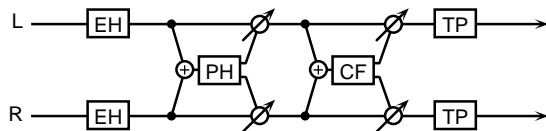

<EH (Enhancer)>

EH Sens (Enhancer Sensitivity) 0 - 127 [1]
Adjust the depth of the enhancer.

EH Mix (Enhancer Mix Level) 0 - 127 [2]
Adjust the level at which the overtones generated by the enhancer will be mixed with the direct sound.

<PH (Phaser)>

PH Man (Phaser Manual) 100 - 8.0k [3]
Adjust the center frequency at which the sound will be modulated.

PH Rate (Phaser Rate) 0.05 - 6.40 [4]
Adjust the modulation speed.

PH Depth (Phaser Depth) 0 - 127 [5]
Adjust the modulation depth.

PH Reso (Phaser Resonance) 0 - 127 [6]
Adjust the emphasis for the region around the center frequency specified by the PH Man parameter.

PH Mix (Phaser Mix) 0 - 127 [7]
Adjust the proportion of the phase-shifted sound that will be mixed with the direct sound.

<CF (Chorus/Flanger)>

CF Sel (CF Select) Chorus/Flangr [8]
Select either Chorus or Flanger.

CF LPF (CF Low Pass Filter) 250 - 6.3k/Bypass [9]
Cut the high frequency range of the chorus or flanger sound.

CF Dly (CF Pre Dealy) 0 - 100m [10]
Adjust the time from the direct sound until when the chorus or flanger sound is heard.

CF Rate 0.05 - 6.40 [11]
Adjust the modulation speed.

CF Depth 0 - 127 [12]
Adjust the modulation depth.

CF Fb (CF Feedback Level) -98% - +98% [13]
Adjust the amount (%) of the flanger sound that will be returned to the input. Negative (-) values will invert the phase.
In the case of Chorus, this will have no effect.

CF Mix 0 - 127 [14]
Adjust the volume of the effect sound.

<TP (Tremolo/Pan)>

TP Sel (TP Select) Trem/Pan [15]
Select either Tremolo or Pan.

TP Mod WV (TP Modulation Wave) Tri/Sqr/Sin/Saw1/Saw2 [16]
Select the way in which tremolo or pan will be modulated.

- Tri** : The sound will be modulated like a triangle wave.
- Sqr** : The sound will be modulated like a square wave.
- Sin** : The sound will be modulated like a sine wave.
- Saw1,2** : The sound will be modulated like a sawtooth wave. The "teeth" in Saw1 and Saw2 point in opposite directions.



+TP Mod RT (TP Modulation Rate) 0.05 - 6.40 [17]
Adjust the modulation speed.

#TP Mod Dep (TP Modulation Depth) 0 - 127 [18]
Adjust the modulation depth.

TP Sw (TP Switch) Off/On [19]
Turn tremolo or pan on/off.

Level (Output Level) 0 - 127 [20]
Adjust the output level.

55: Keyboard Multi [05H, 00H]

Keyboard Multi provides Ring Modulator (RM), Equalizer (EQ), Pitch Shifter (PS), Phaser (PH) and Delay (Dly) effects connected in series.

Ring Modulator is an effect which applies amplitude modulation (AM) to the input signal, producing bell-like sounds.

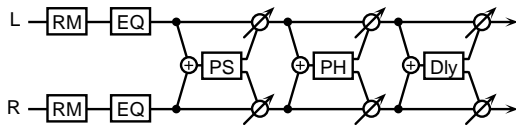

<RM (Ring Modulator)>

+RM Mod Freq (RM Modulation Frequency) 0 - 127 [1]
Set the frequency at which modulation will be applied.

#RM Bal (RM Balance) D > 0E - D 0 < E [2]
Adjust the balance between the direct and the ring modulated sound.
“D” or “E” on the display respectively means D(direct sound) or E(effect sound) values of 100.

<EQ (Equalizer)>

EQ L Gain (EQ Low Gain) -12 - +12 [3]
Adjust the low range gain of the equalizer.

EQ M Fq (EQ Mid Frequency) 200 - 6.3k [4]
Set the center frequency for the equalizer mid-range.

EQ M Q (EQ Mid Q) 0.5/1.0/2.0/4.0/9.0 [5]
Adjust the width of the area centered at the EQ M Fq setting in which the gain will be affected. The area affected will become narrower as this value is increased.

EQ M Gain (EQ Mid Gain) -12 - +12 [6]
Adjust the gain of the area specified by the EQ M Fq parameter and the EQ M Q parameter.

EQ H Gain (EQ High Gain) -12 - +12 [7]
Adjust the high-range gain of the equalizer.

<PS (Pitch Shifter)>

PS Coarse (PS Coarse Pitch) -24 - 0 - +12 [8]
Adjust the amount of pitch shift in semitone steps (-2 to +1 octaves).

PS Fine (PS Fine Pitch) -100 - 0 - +100 [9]
Make fine adjustments to the pitch shift in 2-cent steps (-100 to +100 cents).

PS Mode (PS Shifter Mode) 1 - 5 [10]
As this value is increased, the response will become slower but the sound will be more stable.

PS Bal (PS Balance) D > 0E - D 0 < E [11]
Adjust the volume balance between the direct and the pitch shifted sound.
“D” or “E” on the display respectively means D(direct sound) or E(effect sound) values of 100.

<PH (Phaser)>

PH Man (Phaser Manual) 100 - 8.0k [12]
Set the center frequency at which the phaser sound will be modulated.

PH Rate (Phaser Rate) 0.05 - 6.40 [13]
Adjust the modulation speed of the phaser.

PH Depth (Phaser Depth) 0 - 127 [14]
Adjust the modulation depth of the phaser.

PH Reso (Phaser Resonance) 0 - 127 [15]
Adjust the emphasis for the region in the area of the center frequency specified by the PH Man parameter.

PH Mix (Phaser Mix) 0 - 127 [16]
Adjust the proportion at which the phase-shifted sound will be mixed with the original sound.

<Dly (Delay)>

Dly Time (Delay Time) 0m - 635m [17]
Adjust the time from the original sound until when the delay sound is heard.

Dly Fb (Delay Feedback Level) 0 - 127 [18]
Adjust the amount of the delay sound that is returned to the input.

Dly Mix (Delay Mix Level) 0 - 127 [19]
Adjust the proportion at which the delay sound is mixed with the direct sound.

Level (Output level) 0 - 127 [20]
Adjust the output level.

○ **Effects that connect two types of effect in parallel (parallel 2)**

Effect types in which two different effects are connected in parallel allow you to apply different effects to L and R independently. By using parallel effects for the sound of two Parts, you can achieve a result as if two separate effect units were used.

For example you might select a guitar sound for Part 1 and an organ sound for Part 2. Then set the pan setting to L63 (far left) for Part 1, and to R63 (far right) for Part 2. Apply the effect “59: OD/Rotary” to both Parts 1 and 2. By then making appropriate settings for the “OD Pan” and “RT Pan” effect parameters, you can apply Overdrive to the guitar sound and Rotary to the organ sound, effectively allowing you to use two separate effects at once.

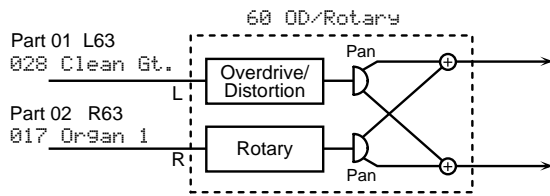

Dly Pan (Delay Output Pan) L63 - 0 - R63 [18]
Adjust the stereo position of the delay sound. L63 is far left, 0 is center, and R63 is far right.

Dly Level (Delay level) 0 - 127 [19]
Adjust the volume of the delay sound.

Level (Output level) 0 - 127 [20]
Adjust the output level.

56: Cho / Delay (Chorus / Delay) [11H, 00H]

This effect connects a chorus and a delay in parallel.

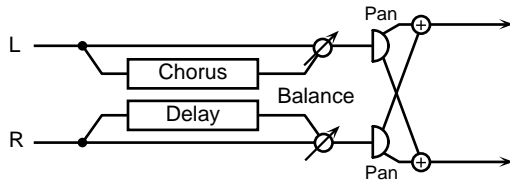

Cho Dly (Chorus pre delay) 0 - 100m [1]
Adjust the time delay from when the direct sound begins until the chorus sound is heard.

Cho Rate (Chorus rate) 0.05 - 10.0 [2]
Adjust the modulation speed of the chorus effect.

Cho Depth (Chorus depth) 0 - 127 [3]
Adjust the modulation depth of the chorus effect.

+Cho Bal (Chorus balance) D> 0E - D 0<E [5]
Adjust the volume balance between the direct and the chorus sound.
“D” or “E” on the display respectively means D(direct sound) or E(effect sound) values of 100.

Cho Pan (Chorus Output Pan) L63 - 0 - R63 [16]
Adjust the stereo position of the chorus sound. L63 is far left, 0 is center, and R63 is far right.

Cho Level (Chorus Level) 0 - 127 [17]
Adjust the volume of the chorus sound.

Dly Time (Delay time) 0 - 500m [6]
Adjust the time delay from when the direct sound begins until the delay sound is heard.

Dly Fb (Delay feedback level) -98% - +98% [7]
Adjust the proportion (%) of the delay sound that is fed back into the delay input. Negative (-) settings will invert the phase.

Dly HF (Delay HF damp) 315 - 8k/Bypass [8]
Adjust the frequency above which delayed sound fed back to the delay input will be cut. If you do not wish to cut the high frequencies of the feedback, set this parameter to Bypass.

#Dly Bal (Delay balance) D> 0E - D 0<E [10]
Adjust the volume balance between the direct and the delay sound.
“D” or “E” on the display respectively means D(direct sound) or E(effect sound) values of 100.

57: FL / Delay (Flanger / Delay) [11H, 01H]

This effect connects a flanger and a delay in parallel.

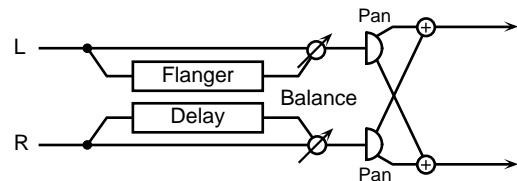

FL Dly (Flanger pre delay) 0 - 100m [1]
Adjust the time delay from when the direct sound begins until the flanger sound is heard.

FL Rate (Flanger rate) 0.05 - 10.0 [2]
Adjust the modulation speed of the flanger effect.

FL Depth (Flanger depth) 0 - 127 [3]
Adjust the modulation depth of the flanger effect.

FL Fb (Flanger feedback level) -98% - +98% [4]
Adjust the proportion (%) of the flanger sound that is fed back into the effect. Negative (-) settings will invert the phase.

+FL Bal (Flanger balance) D> 0E - D 0<E [5]
Adjust the volume balance between the direct and the flanger sound.
“D” or “E” on the display respectively means D(direct sound) or E(effect sound) values of 100.

FL Pan (Flanger Output Pan) L63 - 0 - R63 [16]
Adjust the stereo position of the flanger sound. L63 is far left, 0 is center, and R63 is far right.

FL Level (Flanger level) 0 - 127 [17]
Adjust the volume of the flanger sound.

Dly Time (Delay time) 0 - 500m [6]
Adjust the time delay from when the direct sound begins until the delay sound is heard.

Dly Fb (Delay feedback level) -98% - +98% [7]
Adjust the proportion (%) of the delay sound that is fed back into the delay input. Negative (-) settings will invert the phase.

Dly HF (Delay HF damp) 315 - 8k/Bypass [8]
Adjust the frequency above which delayed sound fed back to the delay input will be cut. If you do not want to cut the high frequencies of the delay feedback, set this parameter to Bypass.

- #Dly Bal (Delay balance) D> 0E - D 0<E [10]
Adjust the volume balance between the direct and the delay sound.
“D” or “E” on the display respectively means D(direct sound) or E(effect sound) values of 100.
- Dly Pan (Delay Output Pan) L63 - 0 - R63 [18]
Adjust the stereo position of the delay sound. L63 is far left, 0 is center, and R63 is far right.
- Dly Level (Delay Level) 0 - 127 [19]
Adjust the volume of the delay sound.
- Level (Output level) 0 - 127 [20]
Adjust the output level.

58: Cho / Flanger (Chorus / Flanger) [11H, 02H]
This effect connects a chorus and a flanger in parallel.

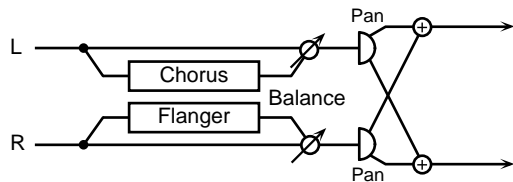

- Cho Dly (Chorus pre delay) 0 - 100m [1]
Adjust the time delay from when the direct sound begins until the chorus sound is heard.
- Cho Rate (Chorus rate) 0.05 - 10.0 [2]
Adjust the modulation speed of the chorus effect.
- Cho Depth (Chorus depth) 0 - 127 [3]
Adjust the modulation depth of the chorus effect.
- +Cho Bal (Chorus balance) D> 0E - D 0<E [5]
Adjust the volume balance between the direct and the chorus sound.
“D” or “E” on the display respectively means D(direct sound) or E(effect sound) values of 100.
- Cho Pan (Chorus Output Pan) L63 - 0 - R63 [16]
Adjust the stereo position of the chorus sound. L63 is far left, 0 is center, and R63 is far right.
- Cho Level (Chorus Level) 0 - 127 [17]
Adjust the volume of the chorus sound.

- FL Dly (Flanger pre delay) 0 - 100m [6]
Adjust the time delay from when the direct sound begins until the flanger sound is heard.
- FL Rate (Flanger rate) 0.05 - 10.0 [7]
Adjust the modulation speed of the flanger effect.
- FL Depth (Flanger depth) 0 - 127 [8]
Adjust the modulation depth of the flanger effect.
- FL Fb (Flanger feedback level) -98% - +98% [9]
Adjust the proportion (%) of the flanger sound that is fed back into the effect. Negative (-) settings will invert the phase.
- #FL Bal (Flanger balance) D> 0E - D 0<E [10]
Adjust the volume balance between the direct and the flanger sound.
“D” or “E” on the display respectively means D(direct sound) or E(effect sound) values of 100.

- FL Pan (Flanger Output Pan) L63 - 0 - R63 [18]
Adjust the stereo position of the flanger sound. L63 is far left, 0 is center, and R63 is far right.
- FL Level (Flanger Level) 0 - 127 [19]
Adjust the volume of the flanger sound.
- Level (Output level) 0 - 127 [20]
Adjust the output level.

59: OD1 / OD2 (Overdrive / Distortion1,2) [11H, 03H]

This connects two effect units in parallel, each of which allows you to select Overdrive or Distortion.

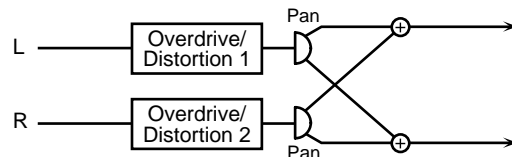

- <OD1 (Overdrive/Distortion 1)>
OD1 Sel (OD1 Select) Odrv/Dist [1]
Select either Overdrive or Distortion for set 1.
- +OD1 Drive (OD1 Drive) 0 - 127 [2]
Adjust the depth of distortion for set 1. The volume will change together with the depth of distortion.
- OD1 Amp (OD1 Amp Simulator Type) Small/Bltn/2-Stk/3-Stk [3]
Select the type of guitar amp for set 1.
- Small** : small amp
 - Bltn** : single-unit type amp
 - 2-Stk** : large double stack amp
 - 3-Stk** : large triple stack amp

OD1 Amp Sw (OD1 Amp Switch) Off/On [4]
Turn OD1 Amp on/off.

OD1 Pan (OD1 Output Pan) L63 - 0 - R63 [16]
Set the stereo location of the overdrive or distortion sound for set 1. L63 is far left, 0 is center, and R63 is far right.

OD1 Level 0 - 127 [17]
Adjust the overdrive or distortion volume for set 1.

<OD2 (Overdrive/Distortion 2)>

OD2 Sel (OD2 Select) Odrv/Dist [6]
Select either Overdrive or Distortion for set 2.

#OD2 Drive (OD2 Drive) 0 - 127 [7]
Adjust the depth of distortion for set 2. The volume will change together with the depth of distortion.

OD2 Amp (OD2 Amp Simulator Type) Small/Bltn/2-Stk/3-Stk [8]

Select the type of guitar amp for set 2.

- Small** : small amp
- Bltn** : single-unit type amp
- 2-Stk** : large double stack amp
- 3-Stk** : large triple stack amp

OD2 Amp Sw (OD2 Amp Switch) Off/On [9]
Turn OD2 Amp on/off.

OD2 Pan (OD2 Output Pan) L63 - 0 - R63 [18]
Set the stereo location of the overdrive or distortion sound for set 2. L63 is far left, 0 is center, and R63 is far right.

OD2 Level 0 - 127 [19]
Adjust the overdrive or distortion volume for set 2.

Level (Output level) 0 - 127 [20]
Adjust the output level.

<OD (Overdrive/Distortion)>

OD Sel (OD Select) Odrv/Dist [1]
Select either Overdrive or Distortion.

+OD Drive (OD Drive) 0 - 127 [2]
Adjust the depth of overdrive or distortion. The volume will change together with the depth of distortion.

OD Amp (OD Amp Simulator Type) Small/Bltn/2-Stk/3-Stk [3]

Select the type of guitar amp for overdrive or distortion.

- Small** : small amp
- Bltn** : single-unit type amp
- 2-Stk** : large double stack amp
- 3-Stk** : large triple stack amp

OD Amp Sw (OD Amp Switch) Off/On [4]
Turn the OD Amp parameter on/off.

OD Pan (OD Output Pan) L63 - 0 - R63 [16]
Set the stereo location of the overdrive or distortion sound. L63 is far left, 0 is center, and R63 is far right.

OD Level 0 - 127 [17]
Adjust the volume of the overdrive or distortion sound.

<RT (Rotary)>

RT L Slow (RT Low Frequency Slow Rate) 0.05 - 10.0 [6]

Adjust the speed of the low-range rotor for the low-speed (Slow) setting.

RT L Fast (RT Low Frequency Fast Rate) 0.05 - 10.0 [7]

Adjust the speed of the low-range rotor for the high-speed (Fast) setting.

RT Lo Accl (RT Low Frequency Acceleration) 0 - 15 [8]

Adjust the time over which the rotation speed of the low-range rotor will change from low-speed to high-speed (or high-speed to low-speed) rotation. Smaller values will require greater time to reach the new rotational speed.

RT Lo Lev (RT Low Frequency Level) 0 - 127 [9]
Adjust the volume of the low-range rotor.

60: OD / Rotary (Overdrive/Distortion, Rotary) [11H, 04H]

This connects Overdrive or Distortion in parallel with Rotary.

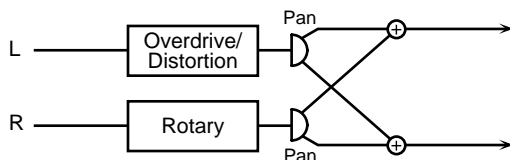

RT H Slow (RT High Frequency Slow Rate) 0.05 - 10.0 [10]
Adjust the speed of the high-range rotor for the low-speed (Slow) setting.

RT H Fast (RT High Frequency Fast Rate) 0.05 - 10.0 [11]
Adjust the speed of the high-range rotor for the high-speed (Fast) setting.

RT Hi Accl (RT High Frequency Acceleration) 0 - 15 [12]
Adjust the time over which the rotation speed of the high-range rotor will change from low-speed to high-speed (or high-speed to low-speed) rotation. Smaller values will require greater time to reach the new rotational speed.

RT Hi Lev (RT High Frequency Level) 0 - 127 [13]
Adjust the volume of the high-range rotor.

RT Sept (RT Separation) 0 - 127 [14]
Adjust the spatial spread of the rotary sound.

#RT Speed Slow/Fast [15]
Simultaneously switch the rotational speed of both the low-range and the high-range rotors.
Slow : Slow down the rotation to the specified speeds (RT L Slow parameter / RT H Slow parameter values).
Fast : Speed up the rotation to the specified speeds (RT L Fast parameter / RT H Fast parameter values).

RT Pan (RT Output Pan) L63 - 0 - R63 [18]
Adjust the stereo position of the rotary sound. L63 is far left, 0 is center, and R63 is far right.

RT Level 0 - 127 [19]
Adjust the volume of the rotary sound.

Level (Output level) 0 - 127 [20]
Adjust the output level.

+OD Drive (OD Drive) 0 - 127 [2]
Adjust the depth of distortion. The volume will change together with the depth of distortion.

OD Amp (OD Amp Simulator Type) Small/BltIn/ 2-Stk/3-Stk [3]
Select the type of guitar amp.
Small : small amp
BltIn : single-unit type amp
2-Stk : large double stack amp
3-Stk : large triple stack amp

OD Amp Sw (OD Amp Switch) Off/On [4]
Turn the OD Amp parameter on/off.

OD Pan (OD Output Pan) L63 - 0 - R63 [16]
Set the stereo location of the overdrive or distortion sound. L63 is far left, 0 is center, and R63 is far right.

OD Level 0 - 127 [17]
Adjust the overdrive or distortion volume.

<PH (Phaser)>

PH Man (Phaser Manual) 100 - 8.0k [6]
Adjust the center frequency at which the sound will be modulated.

#PH Rate (Phaser Rate) 0.05 - 10.0 [7]
Adjust the modulation speed.

PH Depth (Phaser Depth) 0 - 127 [8]
Adjust the modulation depth.

PH Reso (Phaser Resonance) 0 - 127 [9]
Adjust the emphasis for the region around the center frequency specified by the PH Man parameter.

PH Mix (Phaser Mix Level) 0 - 127 [10]
Adjust the proportion of the phase-shifted sound that will be mixed with the direct sound.

PH Pan (Phaser Output Pan) L63 - 0 - R63 [18]
Set the stereo location of the phaser sound. L63 is far left, 0 is center, and R63 is far right.

PH Level 0 - 127 [19]
Adjust the volume of the phaser sound.

Level (Output level) 0 - 127 [20]
Adjust the output level.

61: OD / Phaser(Overdrive/Distortion, Phaser) [11H, 05H]

This connects an overdrive or distortion in parallel with a phaser.

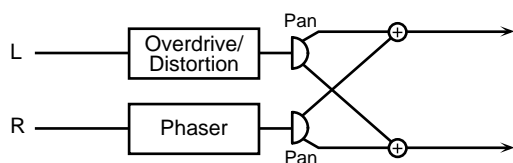

<OD (Overdrive/Distortion)>

OD Sel (OD Select) Odrv/Dist [1]
Select either Overdrive or Distortion.

62: OD / AutoWah (Overdrive/Distortion, Auto-wah) [11H, 06H]

This connects an Overdrive or Distortion in parallel with an Auto-wah.

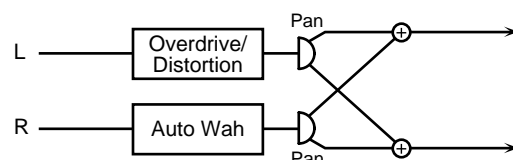

<OD (Overdrive/Distortion)>

OD Sel (OD Select) Odrv/Dist [1]
Select either Overdrive or Distortion.

+OD Drive (OD Drive) 0 - 127 [2]
Adjust the depth of overdrive or distortion. The volume will change together with the depth of distortion.

OD Amp (OD Amp Simulator Type)
Small/BltIn/2-Stk/3-Stk [3]
Select the type of guitar amp for overdrive or distortion.

Small : small amp
BltIn : single-unit type amp
2-Stk : large double stack amp
3-Stk : large triple stack amp

OD Amp Sw (OD Amp Switch) Off/On [4]
Turn the OD Amp parameter on/off.

OD Pan (OD Output Pan) L63 - 0 - R63 [16]
Set the stereo location of the overdrive or distortion sound. L63 is far left, 0 is center, and R63 is far right.

OD Level (OD Level) 0 - 127 [17]
Adjust the volume of the overdrive or distortion sound.

<AW (Auto-wah)>

AW Filter (Auto-wah Filter Type) LPF/BPF [6]
Select the type of filter for the auto-wah.

LPF : The wah effect will be produced over a broad frequency range.
BPF : The wah effect will be produced over a narrow frequency range.

AW Sens (Auto-wah Sensitivity) 0 - 127 [7]
Adjust the sensitivity with which the auto-wah filter will be controlled.

#AW Man (Auto-wah Manual) 0 - 127 [8]
Set the center frequency at which the auto-wah effect will be produced.

AW Peak (Auto-wah Peak) 0 - 127 [9]
Adjust the way in which the wah effect will be applied to the region of the center frequency. Lower settings will produce a wah effect in a broad area around the center frequency, and higher settings will produce a wah effect in a narrower area around the center frequency.

AW Rate (Auto-wah Rate) 0.05 - 10.0 [10]
Adjust the modulation speed of the auto-wah.

AW Depth (Auto-wah Depth) 0 - 127 [11]
Adjust the modulation depth of the auto-wah.

AW Pol (Auto-wah Polarity) Down/Up [12]
Set the direction in which the frequency will change when the auto-wah filter is modulated. With a setting of Up, the filter will change toward a higher frequency. With a setting of Down, it will change toward a lower frequency.

AW Pan (Auto-wah Output Pan) L63 - 0 - R63 [18]
Adjust the stereo position of the auto-wah sound. L63 is far left, 0 is center, and R63 is far right.

AW Level (Auto-wah Level) 0 - 127 [19]
Adjust the volume of the auto-wah sound.

Level (Output level) 0 - 127 [20]
Adjust the output level.

63: PH / Rotary (Phaser, Rotary) [11H, 07H]

This connects a Phaser effect in parallel with a Rotary effect.

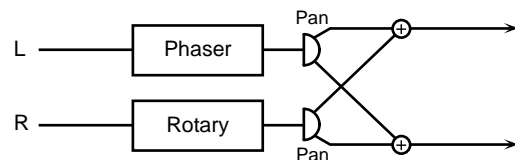

<PH (Phaser)>

PH Man (Phaser Manual) 100 - 8.0k [1]
Adjust the center frequency at which the sound will be modulated.

+PH Rate (Phaser Rate) 0.05 - 10.0 [2]
Adjust the modulation speed of the phaser.

PH Depth (Phaser Depth) 0 - 127 [3]
Adjust the modulation depth of the phaser.

PH Reso (Phaser Resonance) 0 - 127 [4]
Adjust the emphasis for the region around the center frequency specified by the PH Man parameter.

PH Mix (Phaser Mix Level) 0 - 127 [5]
Adjust the proportion of the phase-shifted sound that will be mixed with the direct sound.

PH Pan (Phaser Output Pan) L63 - 0 - R63 [16]
Set the stereo location of the phaser sound. L63 is far left, 0 is center, and R63 is far right.

PH Level (Phaser Level) 0 - 127 [17]
Adjust the volume of the phaser sound.

<RT (Rotary)>

RT L Slow (RT Low Frequency Slow Rate) 0.05 - 10.0 [6]
Adjust the speed of the low-range rotor for the low-speed (Slow) setting.

RT L Fast (RT Low Frequency Fast Rate) 0.05 - 10.0 [7]
Adjust the speed of the low-range rotor for the high-speed (Fast) setting.

RT Lo Accl (RT Low Frequency Acceleration) 0 - 15 [8]
Adjust the time over which the rotation speed of the low-range rotor will change from low-speed to high-speed (or high-speed to low-speed) rotation. Smaller values will require greater time to reach the new rotational speed.

RT Lo Lev (RT Low Frequency Level) 0 - 127 [9]
Adjust the volume of the low-range rotor.

RT H Slow (RT High Frequency Slow Rate) 0.05 - 10.0 [10]
Adjust the speed of the high-range rotor for the low-speed (Slow) setting.

RT H Fast (RT High Frequency Fast Rate) 0.05 - 10.0 [11]
Adjust the speed of the high-range rotor for the high-speed (Fast) setting.

RT Hi Accl (RT High Frequency Acceleration) 0 - 15 [12]
Adjust the time over which the rotation speed of the high-range rotor will change from low-speed to high-speed (or high-speed to low-speed) rotation. Smaller values will require greater time to reach the new rotational speed.

RT Hi Lev (RT High Frequency Level) 0 - 127 [13]
Adjust the volume of the high-range rotor.

RT Sept (RT Separation) 0 - 127 [14]
Adjust the spread of the rotary sound.

#RT Speed Slow/Fast [15]
Simultaneously switch the rotational speed of both the low-range and the high-range rotors.

Slow : Slow down the rotation to the specified speeds (RT L Slow parameter / RT H Slow parameter values).

Fast : Speed up the rotation to the specified speeds (RT L Fast parameter / RT H Fast parameter values).

RT Pan (RT Output Pan) L63 - 0 - R63 [18]
Adjust the stereo position of the rotary sound. L63 is far left, 0 is center, and R63 is far right.

RT Level 0 - 127 [19]
Adjust the volume of the rotary sound.

Level (Output level) 0 - 127 [20]
Adjust the output level.

64: PH / AutoWah (Phaser, Auto-wah) [11H, 08H]

This connects a Phaser effect and an Auto-wah effect in parallel.

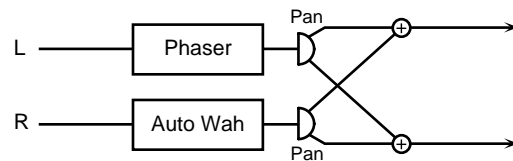

<PH (Phaser)>

PH Man (Phaser Manual) 100 - 8.0k [1]
Adjust the center frequency at which the phaser sound will be modulated.

+PH Rate (Phaser Rate) 0.05 - 10.0 [2]
Adjust the modulation speed of the phaser.

PH Depth (Phaser Depth) 0 - 127 [3]
Adjust the modulation depth of the phaser.

PH Reso (Phaser Resonance) 0 - 127 [4]
Adjust the emphasis for the region around the center frequency specified by the PH Man parameter.

PH Mix (Phaser Mix Level) 0 - 127 [5]
Adjust the proportion of the phase-shifted sound that will be mixed with the direct sound.

PH Pan (Phaser Output Pan) L63 - 0 - R63 [16]
Set the stereo location of the phaser sound. L63 is far left, 0 is center, and R63 is far right.

PH Level (Phaser Level) 0 - 127 [17]
Adjust the volume of the phaser sound.

<AW (Auto-wah)>

AW Filter (Auto-wah Filter Type) LPF/BPF [6]
Select the type of filter for the auto-wah.

LPF : The wah effect will be produced over a broad frequency range.

BPF : The wah effect will be produced over a narrow frequency range.

AW Sens (Auto-wah Sensitivity) 0 - 127 [7]
Adjust the sensitivity with which the auto-wah filter will be modulated.

#AW Man (Auto-wah Manual) 0 - 127 [8]
Set the center frequency at which the auto-wah effect will be produced.

AW Peak (Auto-wah Peak) 0 - 127 [9]
Adjust the way in which the wah effect will be applied to the region of the center frequency. Lower settings will produce a wah effect in a broad area around the center frequency, and higher settings will produce a wah effect in a narrower area around the center frequency.

AW Rate (Auto-wah Rate) 0.05 - 10.0 [10]
Adjust the modulation speed of the auto-wah.

AW Depth (Auto-wah Depth) 0 - 127 [11]
Adjust the modulation depth of the auto-wah.

AW Pol (Auto-wah Polarity) Down/Up [12]
Set the direction in which the frequency will change when the auto-wah filter is modulated. With a setting of Up, the filter will change toward a higher frequency. With a setting of Down it will change toward a lower frequency.

AW Pan (Auto-wah Output Pan) L63 - 0 - R63 [18]
Adjust the stereo position of the auto-wah sound. L63 is far left, 0 is center, and R63 is far right.

AW Level (Auto-wah Level) 0 - 127 [19]
Adjust the volume of the auto-wah sound.

Level (Output level) 0 - 127 [20]
Adjust the output level.

<< When using 3D effects >>

The following four 3D effects utilize RSS (Roland Sound Space) technology to create a spaciousness that cannot be produced by delay, reverb, or chorus etc.

20: 3D Chorus

28: 3D Delay

31: 3D Auto

32: 3D Manual

When using these effects, we recommend that you place your speakers as follows. Also, make sure that the speakers are at a sufficient distance from the walls on either side.

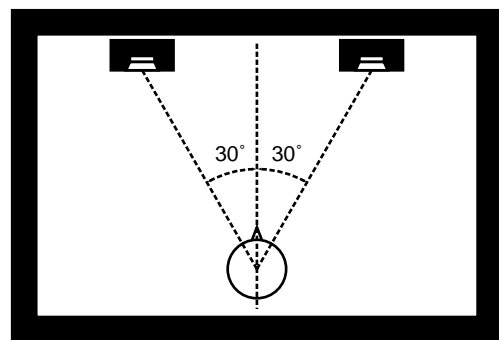

If the left and right speakers are too far apart, or if there is too much reverberation, the full 3D effect may not appear.

Each of these effects has an "Out (Output Mode)" parameter. If the sound from the OUTPUT jacks will be heard through speakers, set this parameter to Speaker. If the sound will be heard through headphones, set it to Phones. This will ensure that the optimal 3D effect will be heard. If this parameter is not set correctly, the full 3D effect may not appear.

■ Using controllers to modify effect parameters

Controllers can be used to modify the values of Insertion effect parameters.

Using MIDI messages to modify effect parameters during a song would require a large amount of data if you were to use only Exclusive messages. Thus, this unit allows you to use controllers to set the main effect parameters. Since you can use Control Change messages to modify parameter values, the amount of data will not be excessively large, even if you modify parameter values during a song.

Also, if you are using a keyboard etc. to play, you can use controllers to modify the values in realtime.

EFX C.Src1, 2 (Effect Control Source 1, 2)

EFX C.Dep1, 2 (Effect Control Depth 1, 2)

● Setting procedure

1. Press [ALL] to make the button indicator light.
2. Simultaneously press PART [l] and [r].
3. Press either [u] or [d] to select the parameter whose setting you wish to change.

You can skip parameters by pressing [u][d], while holding [SELECT].

4. Use INSTRUMENT [l][r] to set the value.

```
PART  INSTRUMENT
ALL >EFX C.Src1: Off
LEVEL PAN  :
100  0 :
```

5. When you finish making settings, simultaneously press PART [l] and [r] to end the procedure.

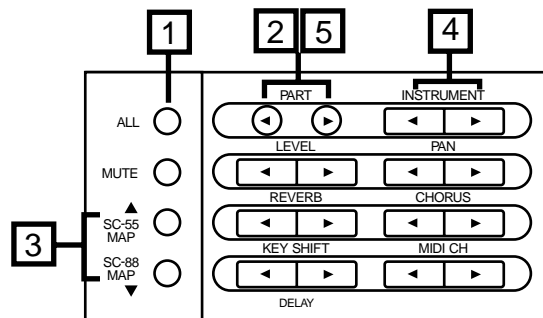

● How each parameter works

○ EFX C.Src1, 2 (Effect Control Source)

Off/CC1 - 95/CAf/Bend

Specify the controllers that you wish to use. EFX C.Src1 will control the parameter marked with a "+" at the left of the parameter name. EFX C.Src2 will control the parameter marked with a "#" at the left of the parameter name.

CC1 - 95 : Controller numbers 1 - 95
CAf : Channel aftertouch
Bend : Pitch bend

* For CC1 - 95, make sure that the setting matches the controller number of the device that is transmitting the MIDI messages.

○ EFX C.Depth 1, 2 (Effect Control Depth)

-100 - +100 (%)

This specifies the percentage of the full parameter range in which change will actually occur when a controller is used. Higher values will allow a greater range of change. If this value is set to 0, the controller will not affect the effect parameter. With negative (-) settings, the change will be inverted. The controller will increase/decrease the value of the effect parameter relative to the value that was set from the panel. At this time, the value displayed on the panel will not change.

When Depth has a positive (+) setting

Panel setting value + value from controller × depth (%) / 100

When Depth has a negative (-) setting

Panel setting value - value from controller × depth (%) / 100

< Example >

The Drive parameter of 5: Overdrive normally changes in the range of 0 - 127.

When this parameter is modified by a controller, it will change in the range of 0 - 127 if the Effect Control Depth value is +100. With a value of +50, it will change in the range of 0 - 64 (i.e., 50% of 127).

Normally → 0 - 127
Depth = +100% → 0 - 127
Depth = +50% → 0 - 64
Depth = -100% → 127 - 0

Examples of using effect controllers

Here are some examples of how effect controllers can be used.

In these examples MIDI messages are used to modify the settings, but these settings can also be controlled from the front panel (p.56, p.92).

Hexadecimal values in the < Settings > sections denote exclusive messages, and hexadecimal values in the < Modifying the value > sections denote control change messages. The exclusive messages are given with device ID 17 (10H) (the factory setting). After the settings in < Settings > have been made, the control change messages described in < Modifying the value > can be transmitted to modify the parameters to the desired value.

For details on exclusive messages, refer to p.191 and following.

● Using Control Change 16 to modify the Drive value of 6: Distortion

< Settings >

1. Turn EFX on for Part 1.
F0 41 10 42 12 40 41 22 01 5C F7
2. Set the effect type to 6: Distortion (value: 01H 11H)
F0 41 10 42 12 40 03 00 01 11 2B F7
3. Set Drive (address: 40H 03H 03H) to 0.
F0 41 10 42 12 40 03 03 00 3A F7
4. Set Effect Control Source 1 (address: 40H 03H 1BH) to CC16 (10H).
F0 41 10 42 12 40 03 1B 10 12 F7
5. Set Effect Control Depth 1 (address: 40H 03H 1CH) to +100% (7FH).
F0 41 10 42 12 40 03 1C 7F 22 F7

< Modifying the value >

B0 10 00 Drive → 0
B0 10 01 Drive → 1
:
:
B0 10 7F Drive → 126
B0 10 7F Drive → 127

● Using Control Change 16 to modify the Speed value of 9: Rotary

< Settings >

1. Turn EFX on for Part 1.
F0 41 10 42 12 40 41 22 01 5C F7
2. Set the effect type to 9: Rotary (value: 01H 22H)
F0 41 10 42 12 40 03 00 01 22 1A F7
3. Set Speed (address: 40H 03H 0DH) to Slow.
F0 41 10 42 12 40 03 0D 00 30 F7
4. Set Effect Control Source 1 (address: 40H 03H 1BH) to CC16 (10H).
F0 41 10 42 12 40 03 1B 10 12 F7
5. Set Effect Control Depth 1 (address: 40H 03H 1CH) to +100% (7FH).
F0 41 10 42 12 40 03 1C 7F 22 F7

< Modifying values >

Since the Speed parameter has only two values, Slow and Fast, the lower half of the range (00H -- 3FH) will select Slow, and the upper half (40H--7FH) will select Fast.

B0 10 00	Speed	→ Slow
:	:	:
B0 10 3F	Speed	→ Slow
B0 10 40	Speed	→ Fast
:	:	:
B0 10 7F	Speed	→ Fast

● Using Control Change 16 to modify the Wah Man value of 50:GTR Multi3

< Settings >

- Turn EFX on for Part 1.
F0 41 10 42 12 40 41 22 01 5C F7
- Set the effect type to 50: GTR Multi 3 (value: 04H 02H)
F0 41 10 42 12 40 03 00 04 02 37 F7
- Set Wah Man (address: 40H 03H 04H) to 0.
F0 41 10 42 12 40 03 04 00 39 F7
- Set Effect Control Source 1 (address: 40H 03H 1BH) to CC16 (10H).
F0 41 10 42 12 40 03 1B 10 12 F7
- Set Effect Control Depth 1 (address: 40H 03H 1CH) to +100% (7FH).
F0 41 10 42 12 40 03 1C 7F 22 F7

< Modifying the value >

B0 10 00	Wah Man	→ 0
B0 10 01	Wah Man	→ 1
:	:	:
B0 10 7E	Wah Man	→ 126
B0 10 7F	Wah Man	→ 127

* For the correspondence between the hexadecimal values and the parameter values, refer to p.183.

● Using Control Change 17 to modify the Feedback value of 10: Stereo Flanger

Example 1: When Effect Control Depth is set to +100

< Settings >

- Turn EFX on for Part 1.
F0 41 10 42 12 40 41 22 01 5C F7
- Set the effect type to 10: Stereo Flanger (value: 01H 23H)
F0 41 10 42 12 40 03 00 01 23 19 F7
- Set Feedback (address: 40H 03H 08H) to -98%.
F0 41 10 42 12 40 03 08 00 35 F7
- Set Effect Control Source 2 (address: 40H 03H 1DH) to CC17 (11H).
F0 41 10 42 12 40 03 1D 11 0F F7
- Set Effect Control Depth 2 (address: 40H 03H 1EH) to +100% (7FH).
F0 41 10 42 12 40 03 1E 7F 20 F7

< Modifying the value >

The Feedback parameter changes in 2% steps, with 40H as the center. (For the correspondence between hexadecimal values and parameter values, refer to the table on p.183.)

B0 11 00	Feedback	→ -98%
:	:	:
B0 11 0F	Feedback	→ -98%
B0 11 10	Feedback	→ -96%
:	:	:
B0 11 3E	Feedback	→ -4%
B0 11 3F	Feedback	→ -2%
B0 11 40	Feedback	→ +/-0%
B0 11 41	Feedback	→ +2%
B0 11 42	Feedback	→ +4%
:	:	:
B0 11 70	Feedback	→ +96%
B0 11 71	Feedback	→ +98%
:	:	:
B0 11 7F	Feedback	→ +98%

● Using Control Change 17 to modify the Feedback value of 10: Stereo Flanger

Example 2: When Effect Control Depth is set to -100

< Settings >

- Turn EFX on for Part 1.
F0 41 10 42 12 40 41 22 01 5C F7
- Set the effect type to 10: Stereo Flanger (value: 01H 23H)
F0 41 10 42 12 40 03 00 01 23 19 F7
- Set Feedback (address: 40H 03H 08H) to +98% (7FH).
F0 41 10 42 12 40 03 08 7F 36 F7
- Set Effect Control Source 2 (address: 40H 03H 1DH) to CC17 (11H).
F0 41 10 42 12 40 03 1D 11 0F F7
- Set Effect Control Depth 2 (address: 40H 03H 1EH) to -100% (00H).
F0 41 10 42 12 40 03 1E 00 1F F7

< Modifying the value >

The Feedback parameter changes in 2% steps, with 40H as the center. (For the correspondence between hexadecimal values and parameter values, refer to the table on p.183.) Since Effect Control Depth is set to -100%, increasing control change values will cause the value of the Feedback parameter to decrease.

B0 11 00	Feedback	→ +98%
:	:	:
B0 11 0F	Feedback	→ +98%
B0 11 10	Feedback	→ +96%
:	:	:
B0 11 3E	Feedback	→ +4%
B0 11 3F	Feedback	→ +2%
B0 11 40	Feedback	→ +/-0%
B0 11 41	Feedback	→ -2%
B0 11 42	Feedback	→ -4%
:	:	:
B0 11 70	Feedback	→ -96%
B0 11 71	Feedback	→ -98%
:	:	:
B0 11 7F	Feedback	→ -98%

Chapter 5

Convenient functions

■ Create and save a sound (User Instrument)

You can modify the parameters of this unit sound to your taste, and save your new settings in Variation numbers 64 or 65 of the Native map / SC-88 map (p.98). A sound saved in this way is called a User Instrument, and this procedure is called User Editing. You can save 256 different sounds in this way.

The following parameters can be set

Vibrato
Filter
Envelope

These parameters are called User Instrument Parameters.

For the function of each parameter, refer to p.31.

The User Instrument sound that is actually heard will reflect the combination of the Part parameter settings and the User Instrument parameter settings. For example if the Vibrato Rate is set to +20 by the Part parameters and to -5 by the User Instrument parameters, the vibrato rate of the sound that is actually heard will be +15 (20-5=15).

Also, if the vibrato, filter, and envelope values are modified by MIDI messages, the values of the Part parameters (p.32) will be modified. In this case, the values of the User Instrument parameters will not change.

* The same contents are stored in both the SC-88 and Native maps.

* For an explanation of messages that modify the sound, such as System Exclusive messages and NRPN messages, refer to p.132, 133.

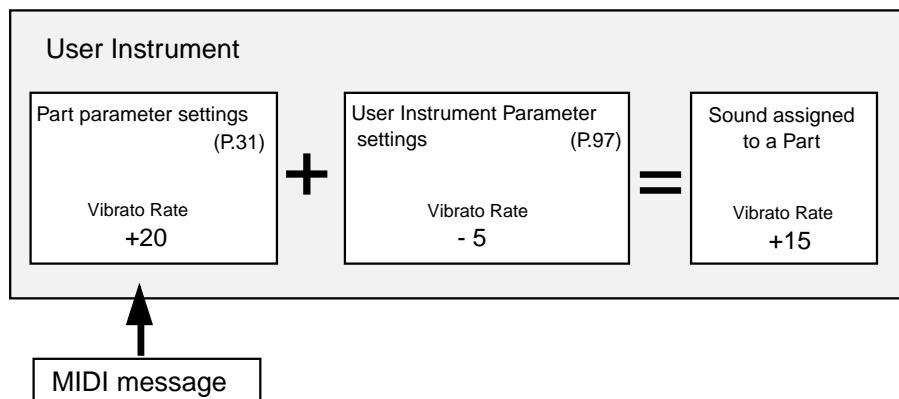

● Procedure for creating and storing a sound

1. **Make sure that the [ALL] indicator is dark.**
If it is lit, press the [ALL] button to turn it off.
2. **Use PART [l] [r] to select a normal Part, then use the INSTRUMENT [l] [r] buttons to select the sound you wish to start from.**

Your edits will apply to this sound.

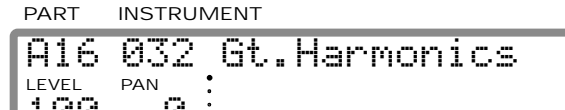

3. **Press [USER INST] and [SELECT] simultaneously, the indicator light red.**
Be aware that if this indicator is not lit, you will be editing not User Instrument parameters but Part parameters (p.31).
4. **Press the [SELECT] button and select the parameter you wish to modify. Use the appropriate parameter edit buttons [l] [r] to modify the value.**
For an explanation of parameters and the procedure for modifying them, refer to p.31.

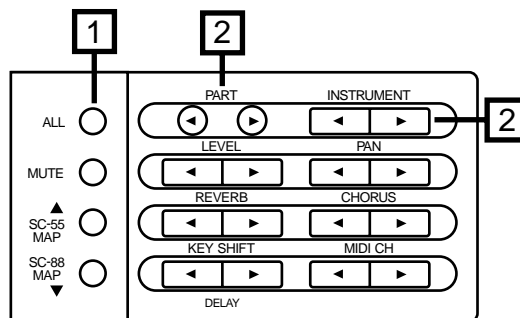

(Example) Vibrato editing display

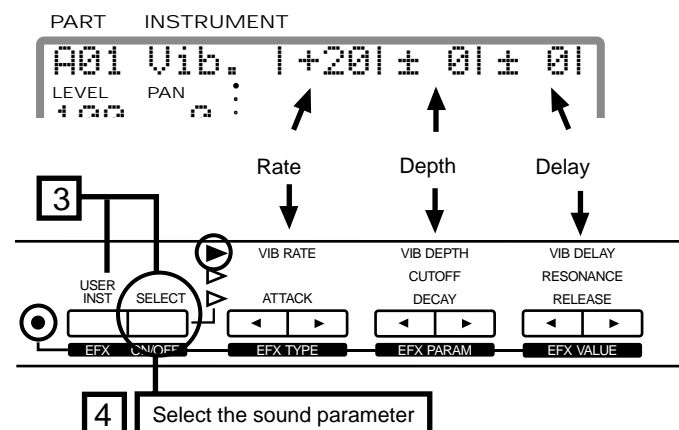

5. Simultaneously press [USER INST] and [SELECT].

The display will ask "Write UI 64/001?". Simultaneously pressing both INSTRUMENT [I] and [r] will move between the two numbers. Use INSTRUMENT [I] [r] to select instrument number (001-128) and the variation number (64 or 65) in which an original sound stored.

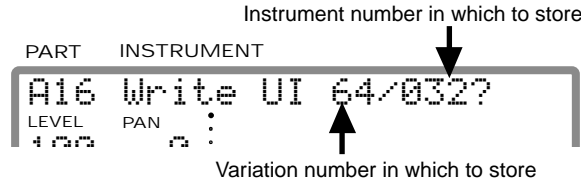

6. When you press [ALL] the sound will be stored.

If you decide not to store, press [MUTE].

7. Press the [USER INST] button to turn off the indicator and complete the procedure.

* User Instrument parameter values can be transmitted as MIDI Exclusive messages (p.107). Data that is transmitted in this way can be saved using a sequencer or computer, and re-transmitted back to this unit to save and restore User Instrument data.

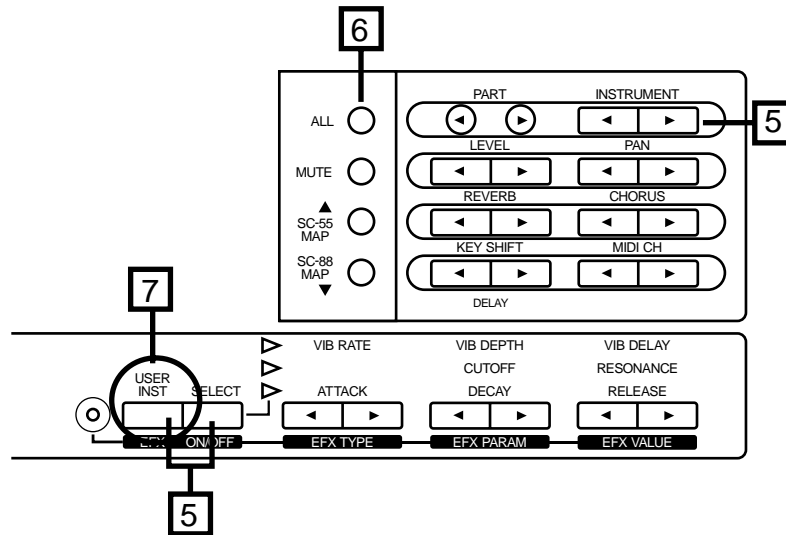

Native map

Storing Locations for User Instruments

Variation number	065	User Tone	User Tone	User Tone	User Tone	...	User Tone
	064	User Tone	User Tone	User Tone	User Tone	...	User Tone
	032			Syn Harpsi			
	024	Piano + Str.	Hard FM EP	Harpsi.c			003 Explosion
	016	European Pt	St.FM EP	Harpsi.w			002 Lasergun
	008	Piano 1w	Detuned EP 2	Couple Hps.			001 Machine Gun
	000	Piano 1	E.Piang 2	Harpsichord	Clav.	...	000 Gun Shot
		001	006	007	008		128
		Instrument number					

■ Creating and saving an Insertion effect (User Effect)

Insertion effect parameter settings that you make can be saved in memory. An Insertion effect that you save in this way is referred to as a User Effect. 64 User Effects can be stored.

* For the function of each parameter, refer to the applicable page. (p.57)

● Saving a User Effect

1. **Set the Insertion effect parameters.**
(“Insertion effect settings,” p.56)
2. **Press the [EFX] button to make the indicator orange.**
Caution is required at this point-- if you happen to change the effect type, all the effect parameters will revert to their defaults.
3. **Simultaneously press [EFX] and [ON/OFF].**
The display will ask “Write U.EFX 01?” Use INSTRUMENT [I][r] to select the number (01 to 64) where you wish to store the data.
4. **To store the data, press [ALL].**
To cancel without storing, press [MUTE].
5. **Press [EFX] to turn off the indicator and complete the procedure.**

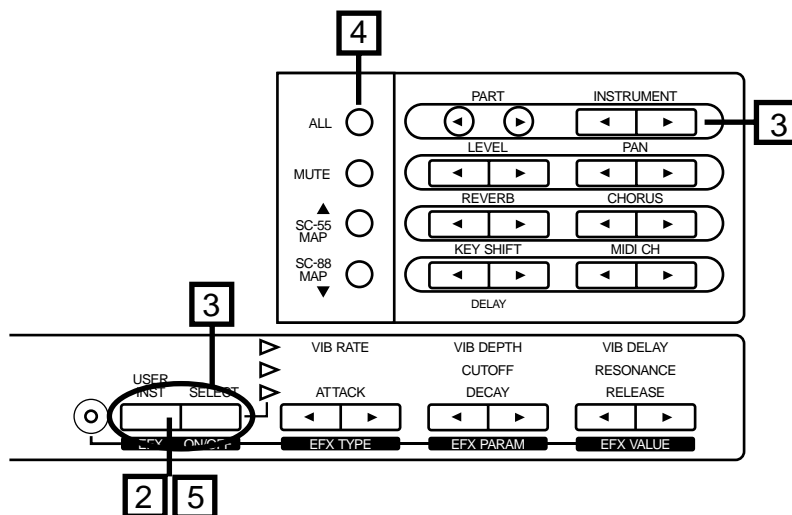

To load the User Effect that was stored, use the following procedure.

1. Press the [ALL] button to make the indicator light orange.
2. Press EFX TYPE [r] to display 64 PH/Auto Wah.
3. Then press EFX TYPE [r], and the User effect will be selected.
The “X” symbol of the effect number indicates that this is a User effect.

```

PART   INSTRUMENT
A01   01X Stereo-EQ
LEVEL  PAN       :
100   0         :
  
```

■ Creating and saving a Patch (User Patch)

You can modify the parameter values of Parts A01 and A02 as desired, assign a Patch name, and save it. A Patch saved in this way is referred to as a User Patch. 16 Patches can be saved in the Patch number locations U01 - U16.

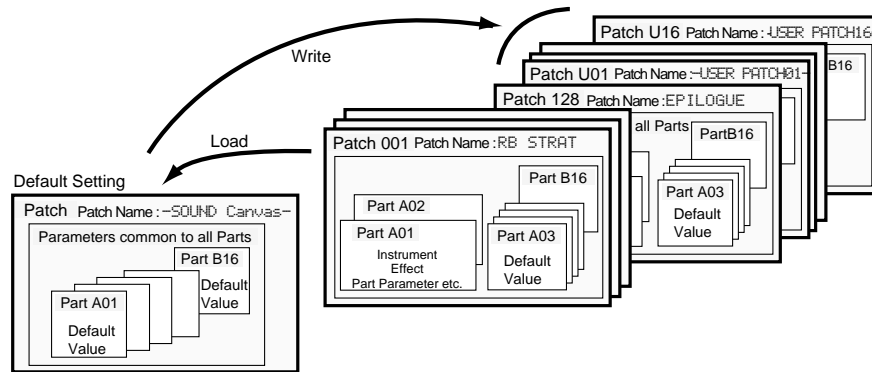

- * All Patch parameters (p.194) are stored. (List of parameters and procedures, p.150)
However, a distinction between GroupA and B of MIDI channels will not be stored. The MIDI channel will be saved as channel "A**" of Group A
- * Drum set parameters are not stored in a Patch.

● Naming a User Patch

1. Press the [ALL] button to make the button indicator light, and use INSTRUMENT [I][r] to select the Patch whose name you wish to modify.

2. Press [ALL] to load Patch.

To cancel without loading, press [MUTE].

3. Simultaneously press PAN [r] and CHORUS [r].

The specified character location will blink.



4. Use PART [I][r] to move the selected character location.

The blinking area will move.

5. Press INSTRUMENT [I][r] and the displayed character will change.

Select the desired character, and return to step 4.

Each time you press [ALL], the character will change case as Ā → ā → Ā → ā.

Pressing [MUTE] will select a space.

Pressing [SC-55MAP] will select 0.

Each time you press [SC-88MAP], the symbol will alternate & → & → & → &.

6. Simultaneously press PAN [r] and CHORUS [r] to end the procedure.

- * To save the User Patch name, perform the procedure of "Saving a User Patch."

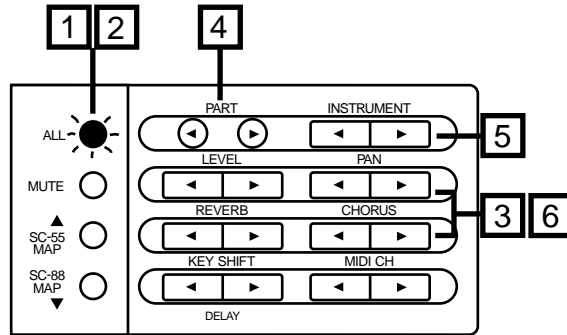

● Saving a User Patch

1. Make the desired settings for the parameters of Parts A01 and A02.
2. Press the [ALL] button to make the button indicator light.
3. Simultaneously press [USER INST] and [SELECT].

The display will ask "Write U.Patch01?". Press INSTRUMENT [I] [r] to select the number (01 - 16) where you wish to store the settings. If you select a number in which a User Patch has already been stored, a "*" symbol will appear, such as "Write*U.Patch01?"

4. If you wish to store the settings, press [ALL].

To cancel without storing, press [MUTE].

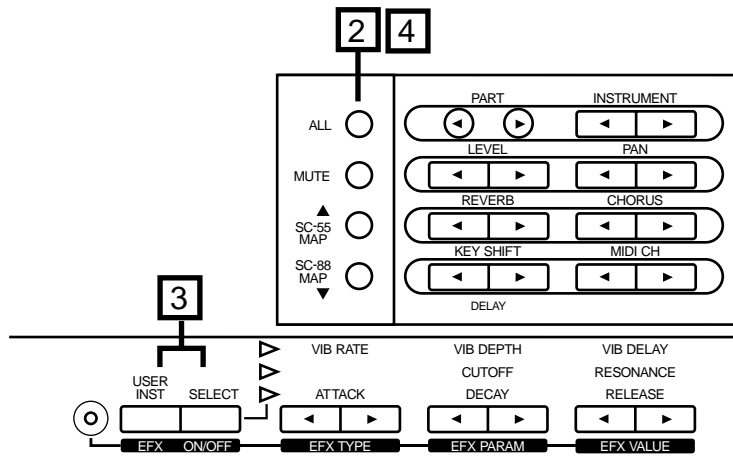

To load the User Patch that was stored, use the following procedure.

1. Press the [ALL] button to make the indicator light.
2. Press INSTRUMENT [r] to select 128 EPILOGUE.
3. Once again press INSTRUMENT [r], and the User Patches will be displayed. Select the User Patch that you wish to load.
4. Press the [ALL] button to load the User Patch.



■ Saving a Drum Set you created (User Drum)

You can modify drum instrument parameters to your liking, and save this data as a Drum Set. A Drum Set saved in this way is called a User Drum Set. You can save up to two Drum Sets, and since each set contains 128 instrumental sounds, this provides a total of 256 instrumental sounds (Drum Instruments). You can also give each User Drum Set a name of your choice. User Drum Sets are stored in Drum Set numbers 65 and 66 of the Native map / SC-88 map (p.104).

* The same contents are stored in both the SC-88 and Native maps.

● Naming a User Drum Set

1. Make sure that the [ALL] indicator is dark.

If it is lit, press [ALL] to turn it off.

2. Use PART [l] [r] to select a Drum Part, simultaneously press PAN [r] and CHORUS [r].

The character at the cursor location will blink.



3. Use PART [l] [r] to move the cursor where you wish to input a character.

The blinking area will move.

4. Use INSTRUMENT [l] [r] to select the desired character.

Then repeat from step **3**.

Each time you press [ALL], the character will change $\bar{a} \rightarrow a \rightarrow \bar{A} \rightarrow A$.

Pressing [MUTE] will enter a space.

Pressing [SC-55 MAP] will select 0.

Each time you press [SC-88 MAP], the symbol will change $\& \rightarrow \zeta \rightarrow \& \rightarrow \zeta$.

If you wish to change the User Drum Set number, simultaneously press both INSTRUMENT [l] and [r] buttons, and then use INSTRUMENT [l] [r] to select the number. However, be aware that if you change the number, the parameter settings will also change.



5. Simultaneously press PAN [r] and CHORUS [r] to end the procedure.

* To store the name of the User Drum Set in memory, follow the steps explained in "Storing an entire Drum Set (procedure 2)" on p.103, 105.

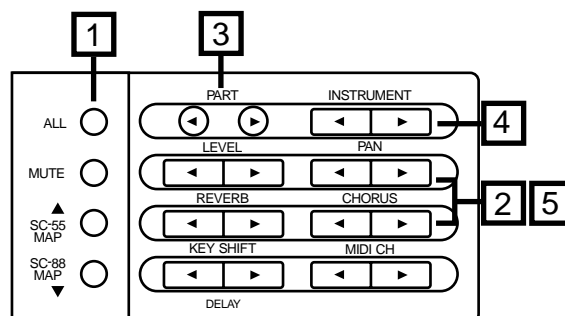

● Storing a Drum instrument

1. Select a Drum Part and Drum Set, and create a drum instrument (“Drum editing procedure” p.42).

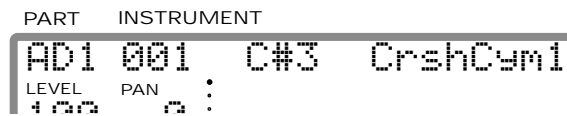

If the above screen is displayed after you create a drum instrument, you can use the following procedure to save your data as a User Drum Set. If the screen display is different than the one shown above, use following procedure **2, 3**.

2. Make sure that the [ALL] indicator is dark.

If it is lit, press [ALL] to turn it off.

3. Simultaneously press [SELECT] and EFX TYPE [I].

The display will show the Part Group (p.23), Part Mode (p.27), Drum Set number, Note name, and Drum Instrument name (p.43).

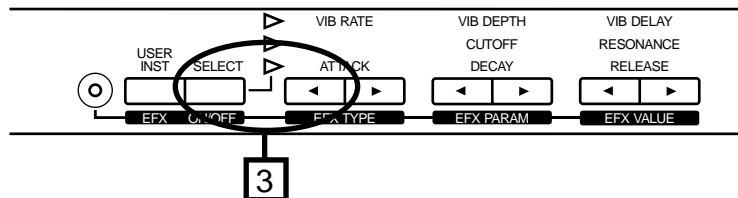
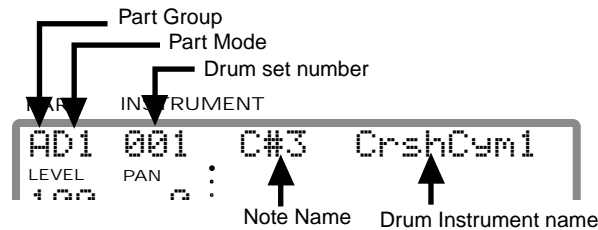

There are two ways to store an edited drum instrument. The first is to store each Drum Instrument individually (procedure 1). The second is to store an entire set of Drum Instruments as a Drum Set (procedure 2).

○ **Storing an individual Drum Instrument (procedure 1)**

The following procedure will store an individual Drum Instrument into the Note Name you specify.

4-1. To store an individual Drum Instrument, simultaneously press the [USER INST] and [SELECT] buttons.

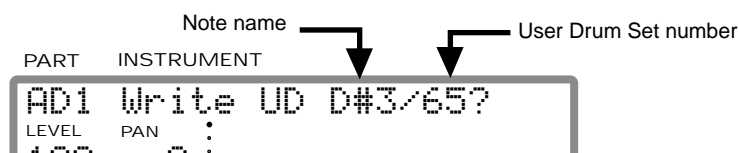

Use the INSTRUMENT [l] [r] buttons to specify the Note Name and the User Drum Set number (65/66) into which the data will be stored. When you simultaneously press the INSTRUMENT [l] [r] buttons, the cursor will move between the Note Name and the Drum Set number.

5. To store the data, press [ALL].

To quit without storing, press [MUTE].

Procedure 1

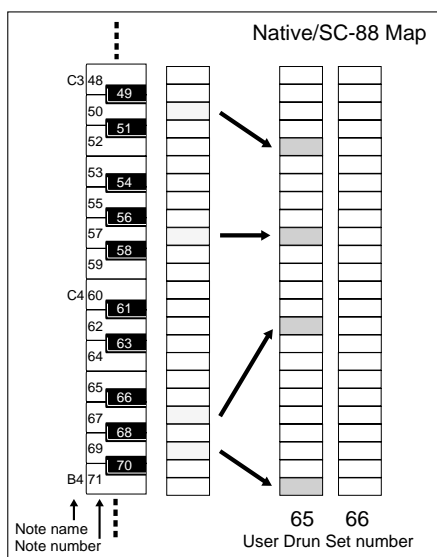

Procedure 2

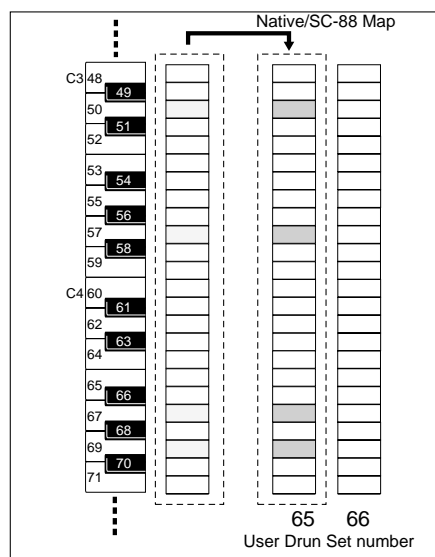

○ **Storing an entire Drum Set (procedure 2)**

The following procedure will store all the Drum Instruments for the entire currently selected Drum Set.

4-2. To store the entire Drum Set, simultaneously press EFX VALUE [l] [r] buttons.

The User Drum set number into which the data will be stored



Use the INSTRUMENT [l] [r] buttons to specify the User Drum Set number (65/66) into which the data will be stored.

5. To store the data, press [ALL].

To quit without storing, press [MUTE].

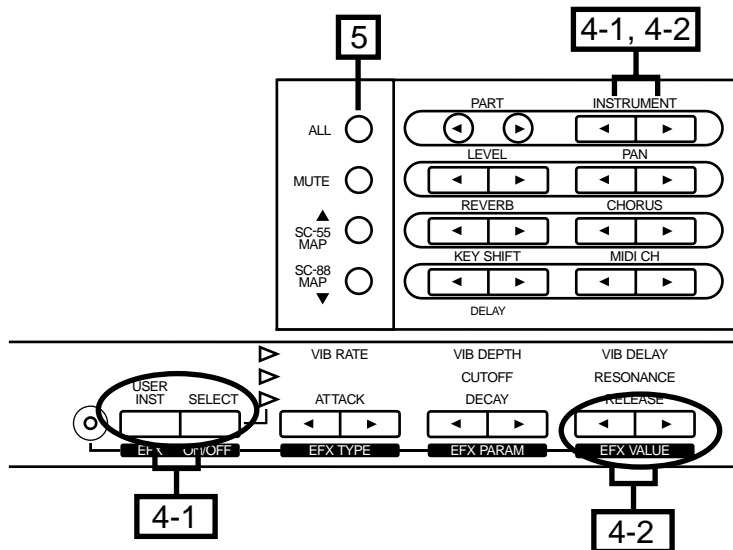

■ Copying or Exchanging settings between Parts / Initializing Part settings

The settings of the selected Part can be copied to another Part or initialized, and you can exchange settings between parts. By using these functions, you can create sounds more efficiently.

● Procedure

- 1. Make sure that the [ALL] indicator is dark.**
If it is lit, press the [ALL] button to make it go dark.
- 2. Use PART [l] [r] to select the source Part.**
- 3. Use the following procedure.**
 - (A) Copy:** While pressing [SELECT], press LEVEL [l].
The display will ask "Copy A01→A02?"
Use INSTRUMENT [l] [r] to select the copy destination Part.
 - (B) Initialize:** While pressing [SELECT], press LEVEL [r].
The display will ask "Clear A01?"
 - (C) Exchange:** While pressing [SELECT], press PAN [l].
The display will ask "Exchs A01↔A02?"
Use INSTRUMENT [l] [r] to select the Part to be exchanged.
- 4. To execute the specified operation, press the [ALL] button.**
To cancel without executing, press the [MUTE] button.

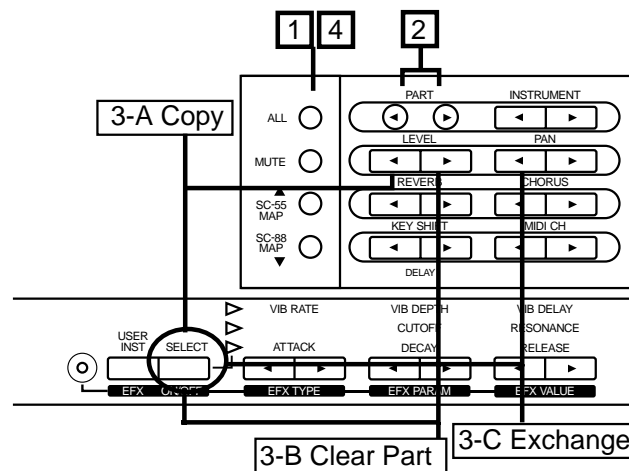

* It is not possible to copy or exchange Drum Parts.

■ Recording all settings on a sequencer

This unit can transmit the contents of its sound source memory as MIDI data. The data can be transmitted in two ways: Bulk Dump which transmits multiple parameters as a group, and Individual Data which allows parameters to be transmitted individually. All data is transmitted as System Exclusive messages.

Use Bulk Dump when you wish to save settings of this unit on a sequencer or personal computer. By transmitting a Bulk Dump, you can also set all parameters of two unit to identical settings.

By transmitting Individual Data, you can create data without having to look up individual System Exclusive messages, letting you create data more efficiently.

● Bulk Dump procedure

1. Set the MIDI OUT/THRU (p.135) select switch to OUT.
2. Use a MIDI cable to connect this unit MIDI OUT/THRU connector to the sequencer's MIDI IN connector.
3. Press [ALL] to make the button indicator light.
4. Simultaneously press both the INSTRUMENT [I] [r] buttons.
The display will ask "Dump ALL, Sure?", and the data is now ready to be transmitted.
5. Use INSTRUMENT [I] [r] to select the type of data you wish to transmit.

ALL	: all parameters of this unit (Including User parameters)
ALL-U	: all parameters except User Parameter (User Instrument, User Drum Set, User Effect and User Patch) settings
U. INST	: User Instrument settings
U. DRUM	: User Drum settings
U. Patch	: User Patch settings
U. EFX	: User Effect settings
GS A	: GS parameters for Part group A
GS B	: GS parameters for Part group B
6. Start the sequencer recording.
7. Press [ALL] and data transmission will begin.
The "Transmitting" display will appear while this unit transmits data.
To cancel data transmission, press [MUTE].
8. When data transmission is complete, stop recording on the sequencer.

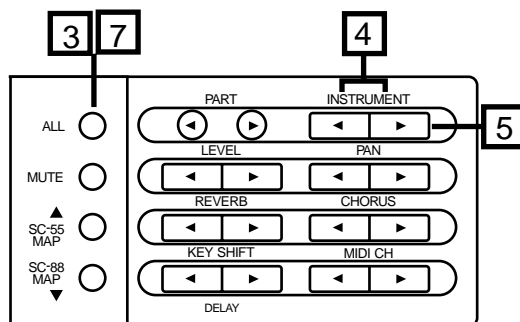

* Since this operation transmits a large amount of data, make sure that the receiving MIDI device has sufficient memory. If the receiving device has insufficient memory, recording will not be completed. If you transmit data for all Parts, the bulk data transmitted by this unit is about 40 Kbytes.

● Transmitting Individual Data

This data can be transmitted in one of three ways: Part parameters can be selected from a menu and transmitted, parameters common to all Parts can be selected from a menu and transmitted, or Insertion Effect parameters can be transmitted.

For the types of parameters which can be transmitted as Individual Data, refer to p.150 "Parameter list and operations."

* When selecting parameters common to all Parts from the menu, the following parameters cannot be transmitted.

Device ID
MUTE Lock
EQ Lock
Rx GM On
Rx GS Reset

- Transmission procedure for Part parameters
- Transmission procedure for parameters common to all parts

1. Part parameters:

Press the [ALL] button to make the indicator dark.

Parameters common to all parts:

Press the [ALL] button to light the indicator.

2. Simultaneously press the PART [l] and [r] buttons.

3. Use [u][d] to select the parameter you wish to transmit.

While holding [SELECT], you can press [u][d] to jump parameters.

4. Part parameters:

Use PART[l][r] to select the Part which will transmit the parameter, and use INSTRUMENT [l][r] to set the value.

Parameters common to all parts:

Use INSTRUMENT [l][r] to set the value.

5. Simultaneously press INSTRUMENT [l] and [r], and the data will be transmitted.

A display of "Transmitting" will appear while the data is being transmitted.

* Be aware that the screen data will not be transmitted from MIDI OUT connector if MIDI OUT/THRU Select (p.136) is set to THRU.

6. Simultaneously press PART [l] and [r] to end the procedure.

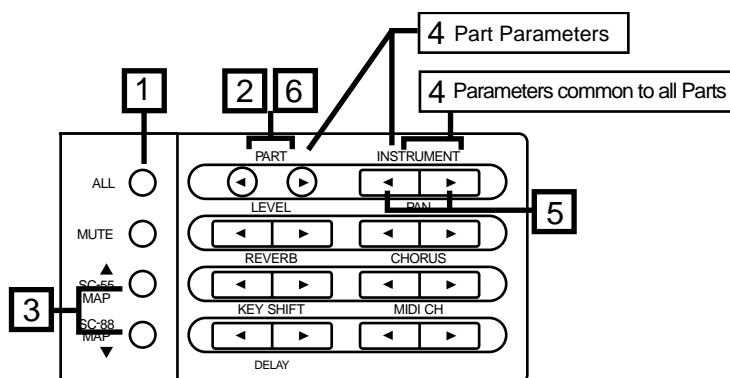

○ Transmission procedure for Insertion Effect parameters

1. Press the [EFX] button to make the indicator light orange.
2. Use the EFX TYPE and EFX PARAM buttons to select the parameter you wish to transmit, and use EFX VALUE to set the value.
3. Press EFX TYPE [l] or [r], and the Effect Type will be displayed. At this time, simultaneously press EFX VALUE [l] and [r], and the Effect Type data will be transmitted.
4. Press EFX PARAM [l] or [r], and the effect parameters will be displayed. At this time, simultaneously press EFX VALUE [l] and [r], and the effect parameter data will be transmitted.

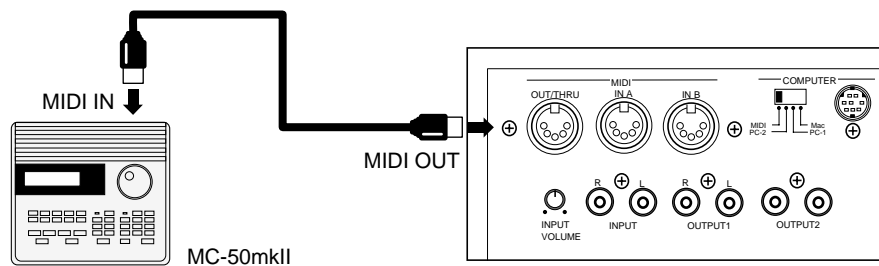
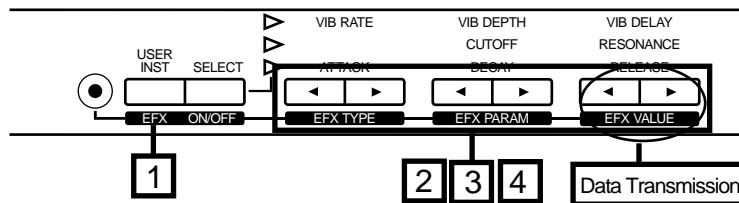

The data will not be transmitted when MIDI OUT/THRU Select (p.136) is set to THRU.

MIDI OUT/THRU Select : OUT
COMPUTER switch : MIDI

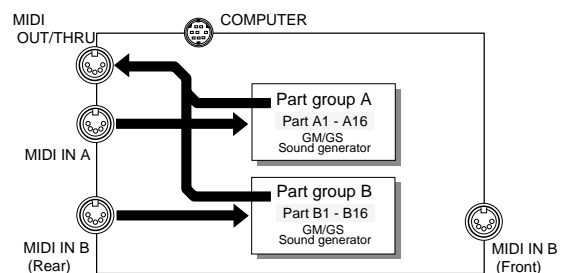

It is also possible to transfer data to a computer via the computer connector without using the MIDI connectors. (p.120)

MIDI OUT/THRU Select : OUT
COMPUTER switch : MAC, PC-1, PC-2

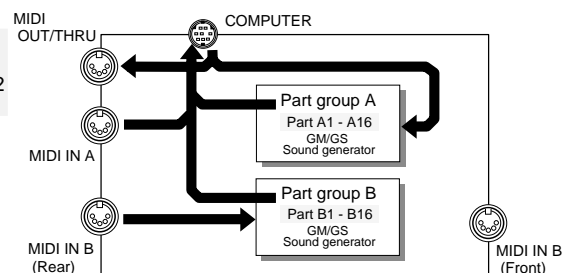

■ Draw pictures or characters in the display (Frame Draw)

You can use the square dots of this unit display to draw pictures or characters. This is called the Frame Draw function. Ten picture screens can be stored. Each of the ten screens is called a "Page." You can transmit the picture data as a MIDI System Exclusive message and save it to a sequencer or computer, and then re-transmit it to this unit to make pictures or characters be displayed in time with the music.

● Creating the picture or character data

1. **Simultaneously press the EFX TYPE [r] and EFX PARAM [l] buttons.**

The display will show "FrameDraw:Page 1".

2. **Use INSTRUMENT [l] [r] to select the page you wish to use.**

3. **Move the cursor, and use the button operations listed below to turn each dot on or off to create a picture or characters.**

The dot will blink at the cursor location.

[u] [d]	: move the cursor up/down
PART [l] [r]	: move the cursor left/right
[ALL]	: turn the dot on (lit)
[MUTE]	: turn the dot off (dark)
CHORUS [l] [r]	: shrink dots/expand dots
LEVEL [l] [r]	: move the displayed picture down/picture up
PAN [l] [r]	: move the displayed picture left/right
INSTRUMENT [l]*[r]	: to transmit the screen data to an external device

* indicates that both buttons must be pressed simultaneously.

* Be aware that the screen data will not be transmitted from MIDI OUT connector if MIDI OUT/THRU Select (p.136) is set to THRU.

4. **To invert / erase / copy the screen data, use the following procedures.**

(A) To invert the screen, press REVERB [l] or [r].

A message will ask "Invert Page *?". Use INSTRUMENT [l] [r] to specify the page to be inverted.

(B) To erase the screen, press MIDI CH [l] or [r].

A message will ask "Clear Page *?". Use INSTRUMENT [l] [r] to specify the page to be cleared.

(C) To copy the screen, press KEY SHIFT [l] or [r].

A message will ask "Copy to Page *?". Use INSTRUMENT [l] [r] to specify the copy destination page.

* In the messages given above, "*" indicates the screen page number.

5. **For each operation, press [ALL] to execute.**

To cancel without executing, press [MUTE].

6. **When you finish, simultaneously press EFX TYPE [r] and EFX PARAM [l] to end the procedure.**

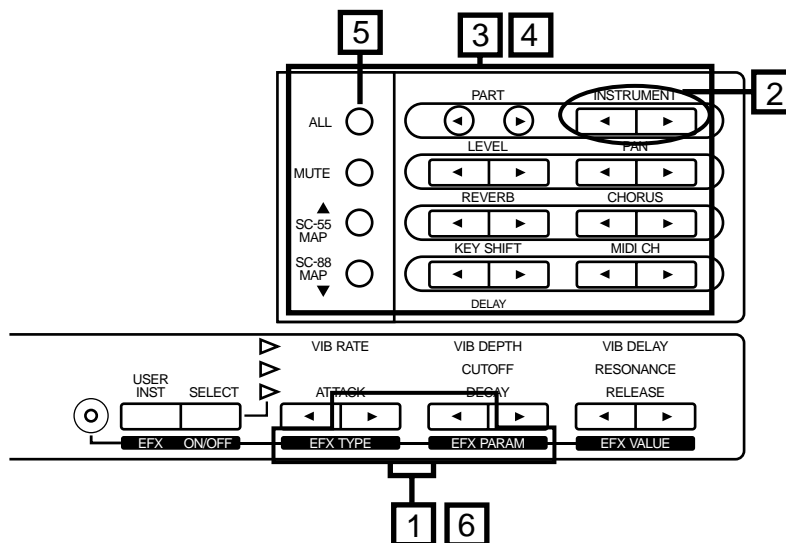

If you wish to display animated pictures

- (1) Use the LEVEL and PAN buttons in step 3 to move the picture and copy it to the next page to create each frame of the animation.
- (2) Then in step **3**. (INSTRUMENT [I]*[r]) transmit the data for each frame and save it in a sequencer (p.107).
- (3) Then, before you start to playback the song, transmit this display data to this unit.
- (4) Use the display select command (exclusive data p.193) to playback the animation.

This allows you to make moving pictures or characters appear in synchronization with the music.

* When screen data is received as a MIDI Exclusive message, the screen data in this unit will be overwritten and lost.

For this procedure, you will need a sequencer (such as the Roland MC-50mkII) that is able to edit, receive and transmit System Exclusive data. Some sequencing software for personal computers is also able to do this. Check the manual for your software.

■ Creating compatible data for the unit / SC-88

This unit has a SC-88-compatibility mode which is convenient when you wish to create data that will be compatible with both this unit and the SC-88.

This unit provides numerous additional sounds. The additional sounds include sounds which replace Capitals and Variation contained in the SC-88 map, and sounds located in new Variation. Of these, the sounds which replace SC-88 map contain the same type of sounds as in the SC-88, and are musically interchangeable with each other. By using these sounds, you can create songs that will playback on either instrument with the generally same musical result. Thus, the SC-88-compatibility mode provides an SC-88-compatible sound map. In the SC-88-compatible sound map, this unit's high-quality sounds are arranged in the same arrangement as the SC-88 map.

The initial settings of this unit, SC-88-compatibility mode-on, and the SC-88 map structure are as shown in the following illustration.

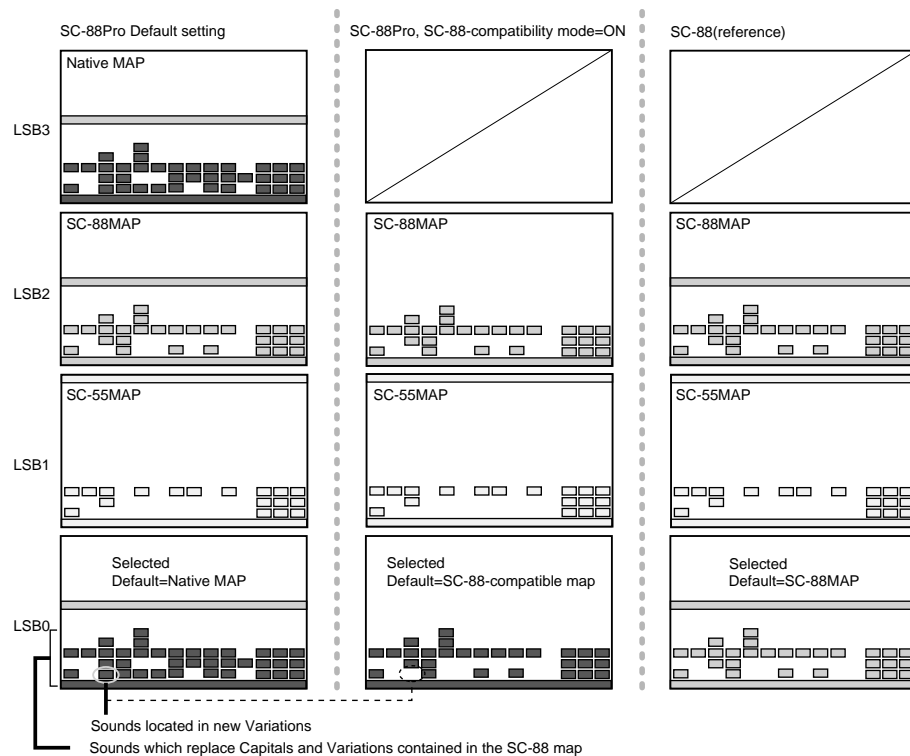

* The LSB is the lower byte of the Bank Select message. When the LSB is specified by a MIDI message, the condition will be as specified by the front panel [SC-88MAP] and [SC-55MAP] buttons. (p.127)

When compared with SC-88, the map structure in SC-88-compatibility mode differs only in that the SC-88-compatible map can be used, and the structure is identical in all other respects.

In SC-88-compatibility mode, specifying a sound with a MIDI message of LSB 0 will normally select the SC-88-compatibility map, but if you press the [SC-88 MAP] button, the SC-88 MAP will be selected. And if you press the [SC-55 MAP] button, the SC-55 MAP will be selected. With the SC-88-compatible map, sounds for this unit will be played, but with SC-88 MAP the same sounds as the SC-88 will be played.

When creating data that must be playable on both this unit and the SC-88, you should usually turn SC-88-compatibility mode on, and use LSB 0 to specify sounds. If you wish to specify SC-55 MAP (or SC-88 MAP), use LSB 1 (or LSB 2) to specify sounds.

* If you use Insertion effects, the SC-88 may not be able to produce the same playback.

● Setting procedure

1. Hold down [SELECT], and press [ALL].

The [ALL] button will blink, and the SC-88-compatibility mode will be turned on. At this time if you press the [SC-88 MAP] button, the [SC-88 MAP] button will light and the SC-88 map will be selected. Alternatively, if you press the [SC-55 MAP] button, the [SC-55 MAP] button will light and the SC-55 map will be selected.

2. To turn off SC-88-compatibility mode, hold down [SELECT] and press [ALL].

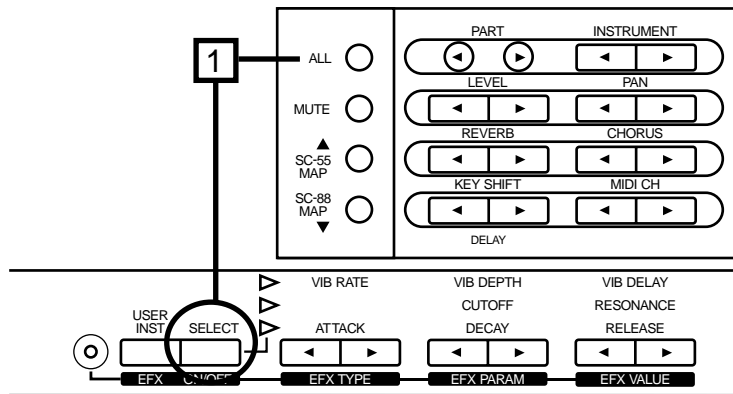

To maintain compatibility with various types of song data such as GM/GS, this unit has three sound maps. These can be accessed as follows.

Type of data	Map for playback	Map setting
GM/GS data	Native map	Default setting
"	SC-55 map	[SC-55MAP]: ON
"	SC-88 map	[SC-88MAP]: ON
Data for SC-88 (LSB0)	Native map	Default setting
" (LSB0)	SC-88 map	[SC-88MAP]: ON
Data for both this unit/SC-88 (LSB0)	SC-88 map	[SC-88MAP]: ON
Data for this unit	Native map	Default setting

For example if you wish to playback GM/GS data using Native map, select the default map setting.

■ Selecting the CM-64 sound map

This unit can be set to the sound map of the Roland CM-64 (Multi-timbre Sound Module). When you wish to play song data that was created for the CM-64, use the following procedure.

- * Be aware that if you select the CM-64 sound map, all previous settings will be lost.
- * If you wish to use the same sounds as the SC-55/55mk II, press [SC-55 MAP] button.

1. While holding down [SELECT], press INSTRUMENT [I].

The display will ask "Init CM-64, Sure?".

2. Press [ALL] and the CM-64 sound map will be selected.

To safely cancel the operation press [MUTE].

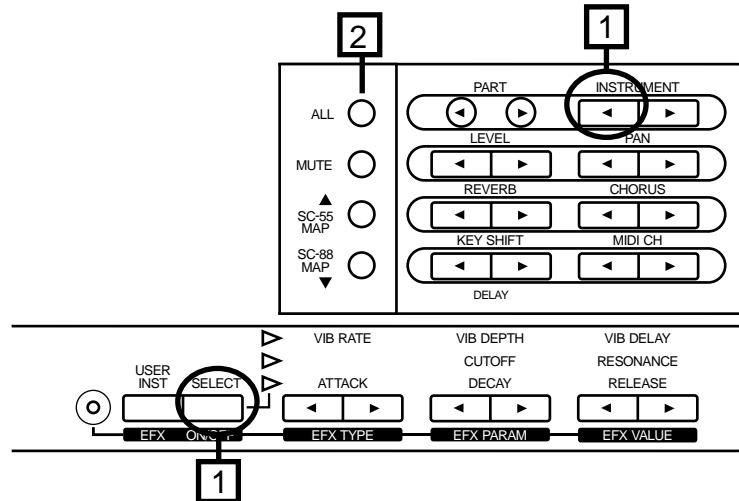

When the CM-64 sound map is selected, the settings of each Part (group A, B) will be as follows.

Part settings

Part name	Rx.Channel	Tone (VARIATION/INSTRUMENT NO)	LEVEL	PAN	REVERB	CHORUS	KEY SHIFT
1	1	Acou Piano 1 (127/001)	100	0	64	0	0
2	2	Slap Bass 1 (127/069)	100	L10	64	0	0
3	3	Str Sect 1 (127/049)	100	L10	64	0	0
4	4	Brs Sect 1 (127/096)	100	L10	64	0	0
5	5	Sax 1 (127/079)	100	L10	64	0	0
6	6	Ice Rain (127/042)	100	L46	64	0	0
7	7	Elec Piano 1 (127/004)	100	R27	64	0	0
8	8	Bottleblow (127/111)	100	L63	64	0	0
9	9	Orche Hit (127/123)	100	R63	64	0	0
10	10	CM-64/32L Set (128)	100	0	64	0	0
11	11	FRETLESS 1 (126/028)	100	0	64	0	0
12	12	CHOIR 1 (126/030)	100	R17	64	0	0
13	13	A.PIANO 1 (126/001)	100	0	64	0	0
14	14	E.ORGAN 2 (126/038)	100	R35	64	0	0
15	15	E.GUITAR 1 (126/014)	100	L37	64	0	0
16	16	SOFT TP 1 (126/047)	100	L19	64	0	0

* Bnd Range: +12, Mod LFO Pch: +4

* The names of these sounds are identical to the names on the CM-64, so they differ from what they are called on this unit.

Settings for all Parts

LEVEL	PAN	REVERB	CHORUS	KEY SHIFT
127	0	64	64	± 0

● Differences between the CM-64 and the unit

When the CM-64 sound map is selected, the playback result will be the same as if a CM-64 were used. However since the internal structure of the sound source is different, the result is not absolutely identical. Please be aware of the following main differences.

1. How the sounds change

When velocity, modulation and aftertouch etc. are used to add expression, the sounds will change in a way slightly different than the CM-64.

2. Exclusive data

This unit is not compatible with CM-64's Exclusive data. If CM-64's Exclusive data is received, this unit's settings will not change. This means that if the song data contains CM-64's sound data (Exclusive data), playing back that song data will not have the same result as it would have on the CM-64.

3. Pan

This unit's pan settings are opposite to those of the CM-64. Please reverse the left/right (L/R) connections of the audio output jacks.

■ Using the unit as two sound modules

This unit has two system modes: Single Module Mode (Mode 1) and Double Module Mode (Mode 2). When Double Module Mode is selected, two types of system effect can be used simultaneously. For example, you could use different types of reverb on Drum Parts than on Normal Parts. Other parameters can also be set separately in two groups.

Insertion effects can be used only for part A.

Normally this unit is in Single Module Mode.

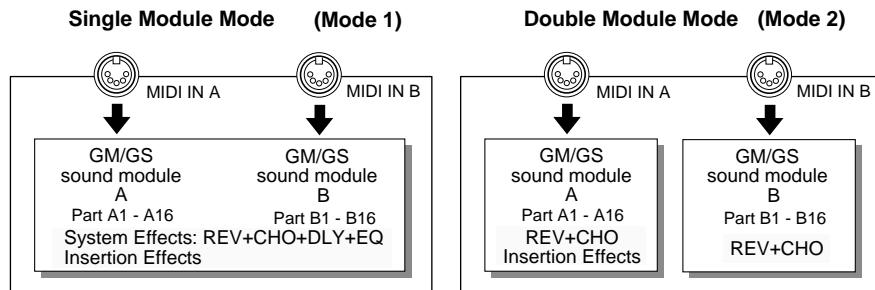

● Selecting Double Module Mode

1. While holding down the [SELECT] button, press KEY SHIFT [r].

The display will ask "Set Mode2, Sure?"

2. Press [ALL] button, and this unit will be in Double Module Mode.

To cancel the operation, press [MUTE].

At the left of the parameter names, there will be an indication of either A or B. This indicates whether you are setting parameters for Part Group A or B. The parameters indicated as either A or B can be set independently for Part Groups A or B. Use the PART [I] [r] buttons to move between groups A and B.



3. To return to Single Module Mode, while holding down the [SELECT] button, press KEY SHIFT [I]. And press [ALL] button.

To cancel the operation, press [MUTE].

- * The selection of Single or Double Module Mode is remembered when the power is turned off. The system mode will not change even if the power is turned off and then on again.
- * Be aware that if you change the operating system mode, the settings of each Part will be initialized (GS Reset).
- * In Double Module mode, the screen display will be inverted. To avoid this, select an appropriate Type setting for Display Type. (p.37)

In both Single Module Mode and Double Module Mode, MIDI messages received at MIDI IN A are sent to Group A Parts, and MIDI messages received at MIDI IN B are sent to Group B Parts (p.23). Be aware that the route by which data is passed between the two MIDI IN connectors and each Part is determined by the System parameter In Mode. (p.137) It is possible to specify the address for Exclusive messages so that an Exclusive message received at MIDI A will be passed to Group B Parts. (p.128)

In Double Module Mode, two groups are provided for the following parameters.

Master Level	(p.35)
Master Pan	(p.35)
Master KEY SHIFT	(p.35)
Master Tune	(p.14)
Reverb Type	(p.52)
Reverb Character	(p.52)
Reverb Pre-LPF (Reverb Pre Lowpass Filter)	(p.52)
Reverb Level	(p.52)
Reverb Time	(p.52)
Reverb Delay Feedback	(p.52)
Chorus Type	(p.53)
Chorus Pre-LPF (Chorus Pre-Lowpass Filter)	(p.53)
Chorus Level	(p.53)
Chorus Feedback (Chorus Feedback Level)	(p.53)
Chorus Delay (Chorus Delay Time)	(p.53)
Chorus Rate	(p.53)
Chorus Depth	(p.53)
Chorus Send Level To Reverb	(p.53)
Mute Lock	(p.140)
Rx GM On (General MIDI System On Receive Switch)	(p.140)
Rx GS Reset (GS Reset Receive Switch)	(p.140)
Device ID number	(p.134)

■ Initialize

● Initialize all Parts to the factory settings

This procedure will initialize all the settings of this unit to the factory settings. This will also initialize System parameters (p.36) and User parameters (p.96).

1. **While holding down [SELECT], simultaneously press both the INSTRUMENT [l] [r] buttons.**

The display will ask "Init All, Sure?".

2. **To initialize, press [ALL].**

To quit without initializing, press [MUTE].

* After the initialization has been performed, the indications in the display for the parameters listed below will show the factory default settings. In fact, however, the settings will not yet at that point be at the defaults. They will be placed at the defaults after you turn power on, then off again.

In Mode, OUT/THRU, IN B Sel. (p.135)

● Initialize for GM/GS

When you wish to playback song data carrying the GM/GS logo, you need to initialize this unit for GM/GS settings. When this is done, this unit will be set to the basic GM/GS settings appropriate for playing back song data carrying the GM/GS logo.

The beginning of song data carrying the GM/GS logo contains data which requests the sound source to initialize itself (General MIDI System On, GS Reset p.133). This means that if you are playing back the song data from the beginning, initialization will be done automatically, and there is no need for you to do it using the front panel buttons.

* Even if this unit is initialized for GS/GM, the System parameter settings (p.36) will not be affected.

* Even if the Backup Switch (p.37) is on, the following procedure will rewrite it to the factory setting.

1. **(For GM) While holding down [SELECT], press PART [r].**
(For GS) While holding down [SELECT], press INSTRUMENT [r].

The display will ask "Init GM, Sure?" or "Init GS, Sure?"

If you perform this operation in Double Module mode (p.116), the display will ask "Init GS A, Sure?". Use INSTRUMENT [l] [r] to specify which module A or B will be initialized.

2. **To initialize, press [ALL].**

To quit without initializing, press [MUTE].

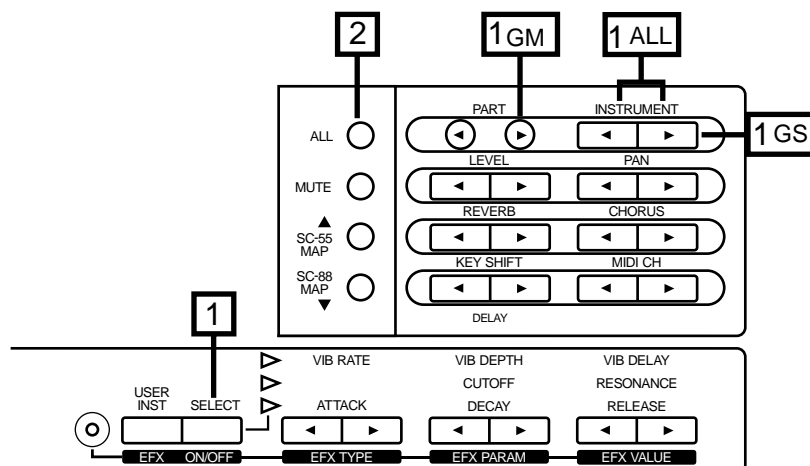

Chapter 6

**Using the unit
with a personal computer**

■ Connections with your computer

This unit can be controlled by music software running on a personal computer. This will allow you to create your own songs, and also to select sounds or edit sounds from the computer display. This type of system is known as a Desk Top Music System (DTMS). The functions provided by a DTMS differ widely depending on the software, so it is important that you choose software suited to your needs.

There are two ways to connect this unit to your computer; using the MIDI connectors or the computer connector. If you use the MIDI connectors, you will need to obtain a computer interface board (adapter) that has MIDI connectors (such as the Roland Super MPU, etc.). If you use this unit's computer connector, you can use a special cable to connect it directly with the computer, but your software must be able to correspond to the serial port.

If you wish to connect your computer via the MIDI connectors, refer to p.122 (Connecting a computer via the MIDI connectors) for how to make connections. The following explanation will show how to make connections using this unit computer connector.

● Connections with computer connector

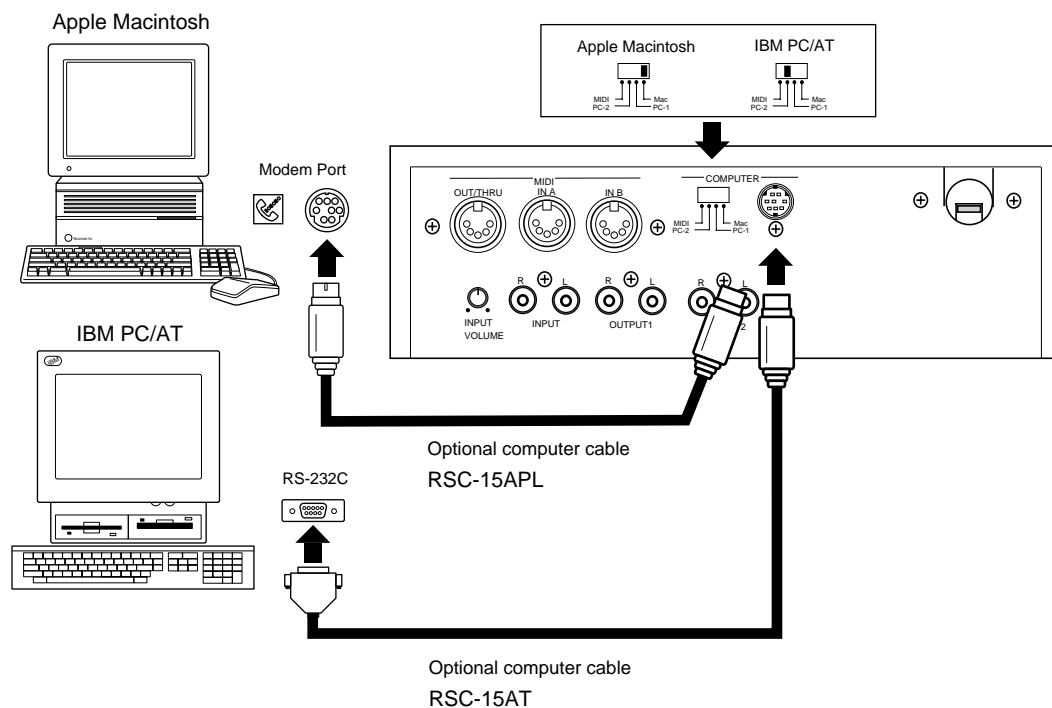

-
1. Turn power of this unit off, and set the **COMPUTER** switch located on the back of this unit.

Note

The Computer switch will be validated when the power is turned off and then on after the setting has been made.

* The setting will depend on the type of computer you have and the software you use.

The PC-1 baud rate is 31.25K (bit/sec), and the PC-2 baud rate is 38.4K (bit/sec). Set the computer switch to the baud rate required by your MIDI application (software). Carefully read the manual for your software regarding the switch setting.

In general, set the switch to Mac for Macintosh series computers, and to PC-2 for IBM PC/AT series computers.

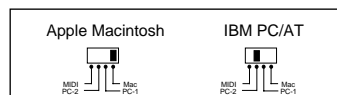

2. Connect the computer cable to the **RS232C** connector or modem port located on the back of your computer.

Types of computer cable

Macintosh series RSC-15APL

IBM PC/AT series RSC-15AT (This is a 9 pin cable. If you need a 25 pin cable, refer to the wiring diagram on p.149 and purchase an appropriate cable.)

3. Connect the other end of the computer cable to this unit's computer connector (**COMPUTER**).
4. Turn power of this unit on.

Caution when using this unit with the IBM PC/AT series

Even if this unit computer connector is connected to your personal computer, it will not operate correctly if the software (MIDI application) is incompatible. Be sure to use software that is compatible with the serial port of the personal computer. In some cases, other computer settings will be necessary, so read the owner's manual for your software carefully, and make the appropriate settings before use.

● Connections with MIDI connectors

* Set the Computer select switch located on the back of this unit to MIDI.

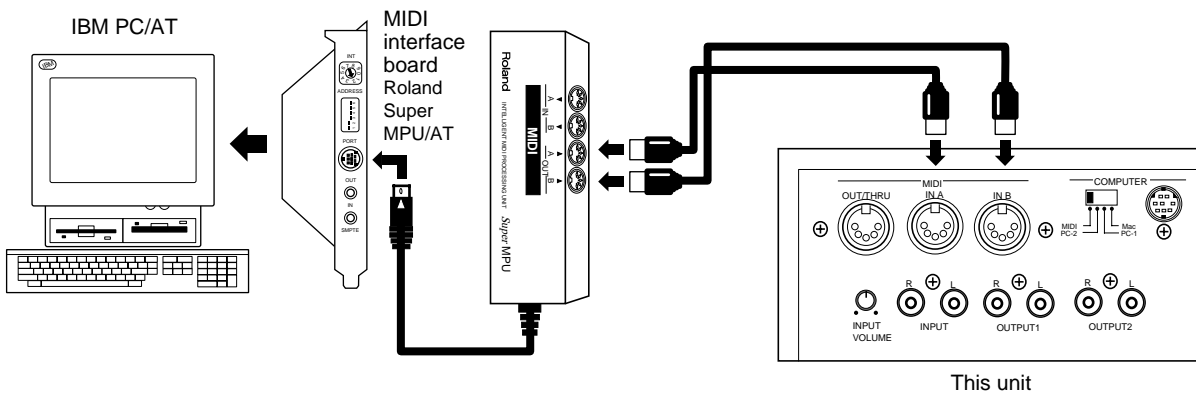
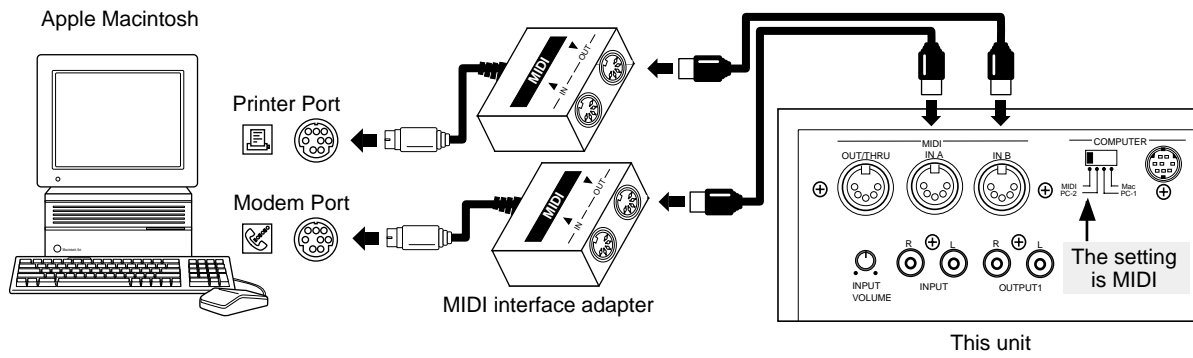

● MIDI data transfer with the computer

Depending on the setting of the computer switch, MIDI data flow will be different as follows (with the factory settings).

○ When the computer switch is set to PC-1, PC-2 or Mac

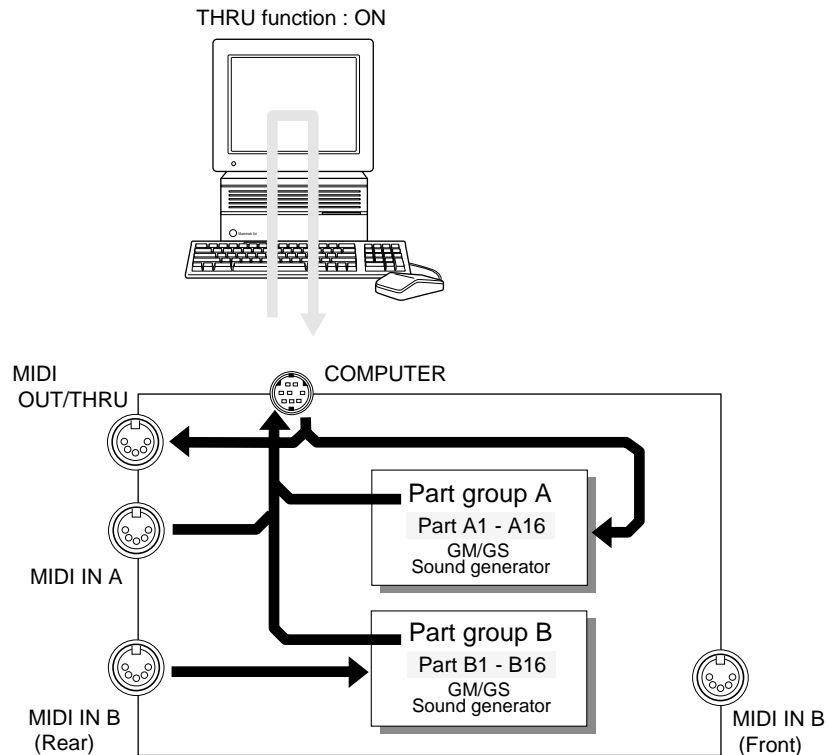

- * In order for data received at MIDI IN A to be sent to the sound generator section, the Thru function of the computer software must be turned on. When thru function is turned on, the data received at MIDI IN A will pass through the computer and be played by the sound generator section. When transmitting MIDI Exclusive data from the sound generator section via this unit's MIDI OUT/THRU connector, it is also necessary for thru function to be on.
- * Data received at MIDI IN B will not be sent to the computer connector, but will be passed directly to the sound generator section.
- * The number of sound generator Parts that can be controlled using the computer connector will depend on the software you are using. This means that if you are using the computer connector, you will not necessarily be able to play 32 Parts. Carefully read the operating manual for your software. Also be aware that although this unit allows two connectors MIDI IN A and B to be used for 32 Part performance, this may be impossible to achieve depending on your software.

○ When the computer switch is set to MIDI

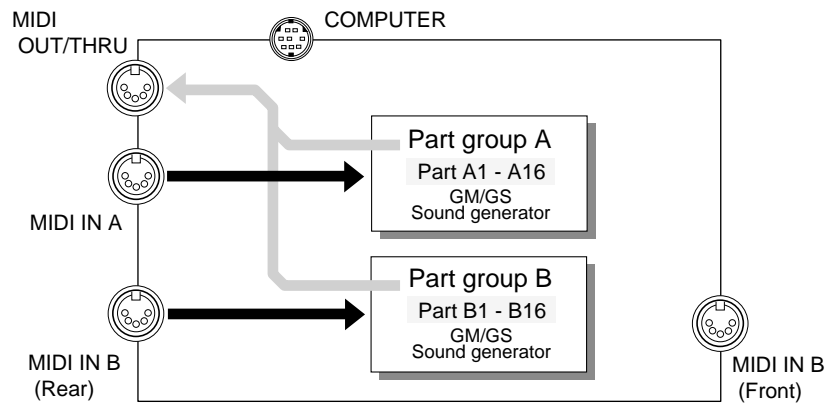

- * Be aware that when the computer switch located on the back of this unit is set to MIDI, data will not be exchanged via the computer connector.
- * If you wish to use the MIDI IN B located on the front panel, you must make the appropriate settings for IN B Select (p.135).
- * With the factory settings, MIDI OUT/THRU is set to function as MIDI OUT. If you wish to use it as MIDI THRU, set the MIDI OUT/THRU select switch (p.136) to THRU.
- * Exclusive data address settings are explained on p.128, 193.
- * With the factory settings, MIDI messages received at MIDI IN A are passed to Group A Parts, and MIDI messages received at MIDI IN B are passed to Group B Parts. In most situations there is no need to change this, but it is possible to change the MIDI signal flow as shown below (p.137, 138).

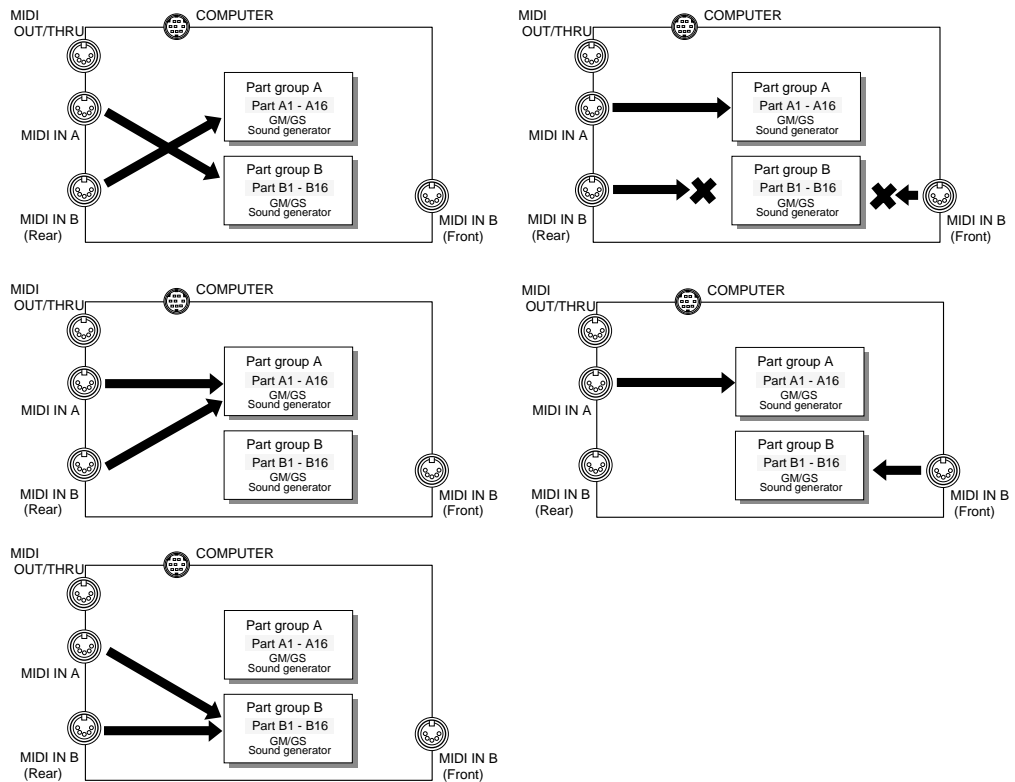

● Connecting another MIDI sound source to the unit

If you wish to connect another MIDI sound source to this unit's MIDI OUT/THRU connector, be aware of the following points.

○ When using another sound source to play data received at the computer connector

In this situation, set MIDI OUT/THRU Select (p.136) to OUT. Computer data received at the computer connector will be transmitted from this unit MIDI OUT/THRU connector.

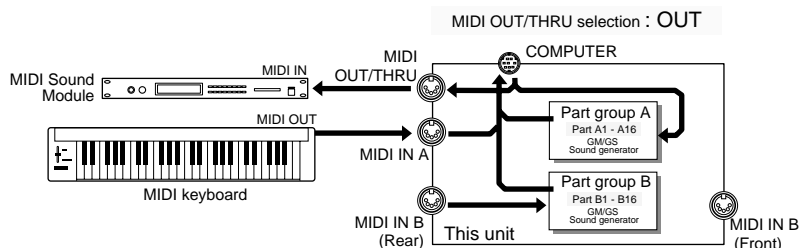

○ When using another sound source to play data received at MIDI IN A

In this situation, set MIDI OUT/THRU Select (p.136) to THRU. Data received at MIDI IN A will be transmitted just as it is from MIDI OUT/THRU.

* Data received at MIDI IN B will not be passed THRU even if THRU is selected. Regardless of the Input Mode setting (In mode p.137), data from MIDI IN B will not be THRUed.

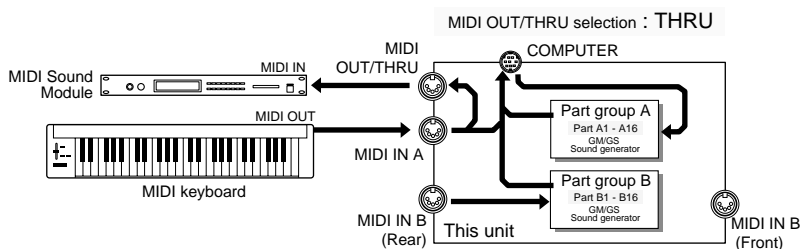

■ Using MIDI messages to select sounds

By sending MIDI messages from a MIDI keyboard or sequencer, you can remotely select the sound (Instrument) for each Part. When you press a sound select button on a MIDI keyboard, a MIDI message selecting a sound will be transmitted

You can also use your personal computer to select this unit sounds. You can specify sounds by inputting the Variation number and the Instrument number (p.21) into your computer program, but depending on your software the way in which numbers are displayed may differ, so be aware of this. On this unit, Variation numbers begin with 0, and Instrument numbers begin with 1.

Variation numbers correspond to MIDI Bank numbers, and Instrument numbers correspond to MIDI Program numbers.

- * MIDI Bank numbers have an upper (MSB) and lower (LSB) part. Each can specify a number 0 - 127, allowing you to specify $128 \times 128 = 16384$ banks. The upper part of the Bank number corresponds to this unit Variation number. The lower part switches between SC-55 map, SC-88 map and Native map. (MIDI Implementation, p.188).
- * For the relation between the sound names and program numbers of your MIDI keyboard, refer to the manual for your MIDI keyboard.
- * If you specify a sound number that this unit does not have, a sound will not change. Refer to the instrument table on p.154 when selecting sounds.

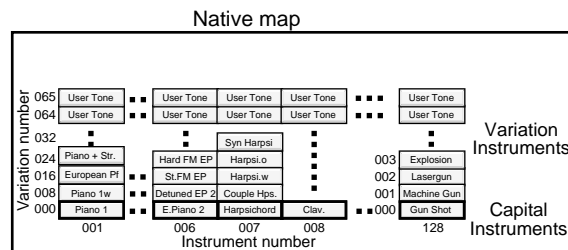

When creating MIDI messages on a sequencer or personal computer and transmitting them, use the following procedure.

1. The value of Control Change 0 : MIDI Bank Number (upper) (this unit's Variation number)
 2. The value of Control Change 32 : MIDI Bank Number (lower)
 3. Program Change value : MIDI Program Number (this unit's instrument number)
1. and 2. are the Bank Select message. Bank Select messages are a type of Control Change message (p.131).

For example if you wish to select the Instrument (Piano3w) with Variation number 8, Instrument number 3, you would transmit the following data to this unit. (Expressed in decimal notation.)

1. The value of Control Change 0 : 8 (Bank number (upper) 8; Variation number 8)
2. The value of Control Change 32 : 0
3. Program Change value : 2 (Program number 3 : Instrument number 3)

- * Note that the data actually transmitted as the Program number will be one less than the Program number.

The example above can be expressed in hexadecimal as follows.

1. BnH 00H 08H
2. BnH 20H 00H
3. CnH 02H

* H indicates that the value is expressed as a hexadecimal number. Decimal 32 is written as hexadecimal 20H.

* n indicates the MIDI channel.

* Note that for MIDI channels and Instrument numbers, the number is one less than the channel or Instrument number. For example if you wish to select a sound on the Part receiving MIDI channel 4, n would be 3. If you wish to select Instrument 3, the value in step 3 would be 2.

This unit processes the lower part of the bank select message (LSB) as follows (p.188).

Least significant byte (LSB)

00H The setting of the [SC-55 MAP] or [SC-88 MAP] button is followed. If the front panel [SC-55 MAP] button is lit, SC-55 map will be selected. If the front panel [SC-88 MAP] button is lit, SC-88 map will be selected. If the button is dark, Native map will be selected.

01H SC-55 map will be selected, and [SC-55 MAP] is lit.

02H SC-88 map will be selected, and [SC-88 MAP] is lit.

03H Native map will be selected, and [SC-55 MAP][SC-88 MAP] is dark.

If we use the previous example of selecting the Piano3w sound, we would transmit

1. BnH 00H 08H
2. BnH 20H 03H
3. CnH 02H

to this unit, and Piano3w of Native map will be selected. If we transmit BnH 20H 01H in step 2, the SC-55 map Piano3w will be selected. If we transmit BnH 20H 02H in step 2, the SC-88 map Piano3w will be selected.

* When SC-55 map is selected, " " symbol will be displayed at the left of the instrument name.

* When SC-88 map is selected, " ' symbol will be displayed at the left of the instrument name.

PART INSTRUMENT

```
A01 001 "Piano 1
LEVEL PAN :
100 a :
```

PART INSTRUMENT

```
A01 001 'Piano 1
LEVEL PAN :
100 a :
```

● Using MIDI messages to select Drum Sets

You can select Drum Sets by transmitting MIDI messages from a MIDI keyboard or sequencer, in the same way as you can select Instruments. When a Program Change message is received, the Drum Set will change. Transmit a Program Change message on the channel being received by the Drum Part. With the factory settings, Part 10 is the Drum Part (MIDI receive channel:10). On this unit, Drum Set numbers correspond to program numbers (p.163).

* Set the note numbers of the rhythm data being played back to match the note numbers of this unit Drum Set you are using (p.164).

Drum Set name and Drum Set number (Program number)



Exclusive data addresses

○ Receiving exclusive data

As listed in "MIDI Implementation" (p.193), the address of MIDI exclusive data (GS format) is defined in units of 16 Parts. In other words, starting from address 40 00 00 are the parameters for 16 Parts. This unit has data for another 16 Parts, making a total of 32 Parts. For this reason, this unit's MIDI exclusive data format expands the addressing, and places the remaining 16 Parts at starting address 50 00 00.

In the same way as with channel messages, exclusive data received at MIDI IN A is passed to Group A Parts, and exclusive data received at MIDI IN B is passed to Group B Parts. In other words, exclusive data for the 32 Parts is received using two MIDI IN connectors. If this is done, each MIDI IN receives exclusive data for 16 Parts, so it is not necessary to split up the data into addresses 40 00 00 and 50 00 00.

However it is also possible for this unit to receive exclusive data for all 32 Parts at a single MIDI IN. In this case it is necessary to use address 50 00 00. For example, the data at starting address 40 00 00 will be passed to Group A Parts, and the data at starting address 50 00 00 received at the same MIDI IN will be passed to Group B Parts. In other words, using starting address 50 00 00 means that the data will be passed to the Parts of the other Group than the MIDI IN that the data was received at.

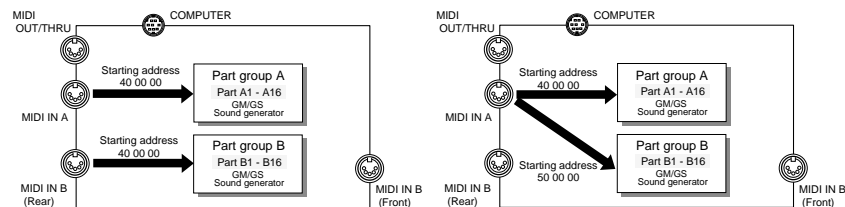

Only in the case of Exclusive data, the System parameter Input Mode (p.137) has no effect on the way in which data is passed from the two MIDI IN connectors to the Parts.

○ Transmitting exclusive data

Since this unit has only one MIDI OUT, the exclusive data transmitted is sent using the two address areas of 40 00 00 and 50 00 00. User sound data is located at starting areas of 20 00 00.

* Be aware that exclusive data will be not transmitted from MIDI OUT connector if the MIDI OUT/THRU select (p.137) is set to THRU.

Chapter 7

MIDI and the unit

■ About MIDI

MIDI stands for Musical Instrument Digital Interface. MIDI devices can transmit musically related data such as performance data or data to select sounds. Since MIDI is a world-wide standard, musical data can be sent and received between devices even if they are of different types and were made by different manufacturers. In the MIDI standard, data describing a musical performance such as “play a note” or “press the pedal” are transmitted as MIDI messages.

As long as you are using this unit to simply play commercially available music data or to provide sound for game software, it is not necessary to know about MIDI. Simply follow the instructions in the manual for your music data playback device (MIDI player) or your software.

The explanation that follows will help you use MIDI to control this unit in greater detail.

● How MIDI messages are transmitted and received

First we will briefly explain how MIDI messages are transmitted and received.

MIDI connectors

MIDI messages are transmitted and received using three types of connector. Connect MIDI cables to these connectors as appropriate for your setup.

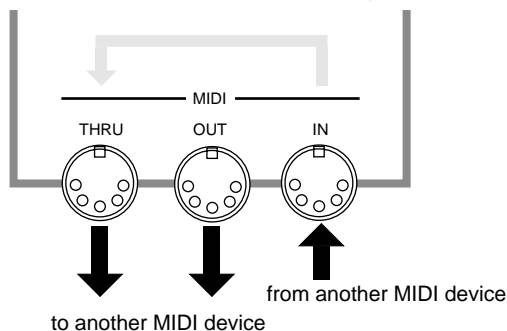

- MIDI IN** : This connector receives messages from another MIDI device.
- MIDI OUT** : This connector transmits messages from this unit.
- MIDI THRU** : This connector retransmits the messages received at MIDI IN.

* It is possible to use MIDI THRU to connect two or more MIDI devices, but in practice the limit is 5 units. This is because as the signal path becomes longer, the signal deteriorates and the messages can no longer be received correctly.

* On this unit, MIDI THRU and MIDI OUT share the same connector. The MIDI OUT/THRU Select switch (p.136) determines which function the connector will have.

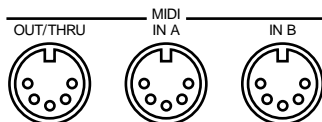

● MIDI channels and multi-timbral sound modules

MIDI transmits a wide variety of performance data over a single MIDI cable. This is made possible by MIDI channels. MIDI channels allow specific data to be selected out of a large amount of data. The concept is similar to the idea of TV channels. By changing the channel of a TV receiver you can view the programs of different stations. By setting the channel of the receiver to match the channel of the transmitter, you can receive only the program you wish to watch. In the same way, MIDI allows you to receive data only when the channel of the receiver matches the channel of the transmitter.

The cable from the antenna carries the TV signals from many broadcast stations.

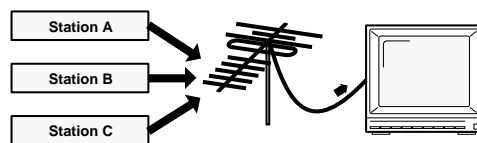

The TV is set to the channel of the station you wish to watch.

MIDI uses sixteen channels, numbered 1 — 16. Music data is received when the transmit channel of the transmitting device matches the receive channel of the receiving device. If you make MIDI channel settings as Fig.1, only sound source B will sound when you play the keyboard, and sound source A will not sound. This is because sound source B matches the transmit channel of the keyboard, but sound source A's channel does not match. Conversely, if you set the transmit channel of the keyboard to match sound source A, sound source A will sound (Fig.2).

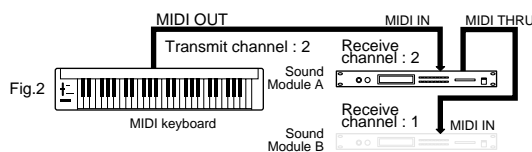
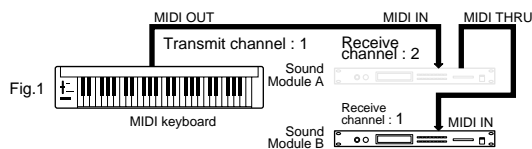

Since this unit has two MIDI IN connectors, it can receive a total of 32 channels simultaneously. By using 32 channels you can play ensembles of 32 Parts (p.23). Sound sources such as this unit which are able to simultaneously play many parts are called multi-timbral sound modules. Timbre is a word meaning sound.

This unit has two types of Parts: Normal Parts and Drum Parts (p.27). Normal Parts are used to play melody or bass lines. On GM/GS sound sources, the Drum Part uses channel 10.

■ MIDI messages that can be received by the unit

MIDI uses many different types of message to transmit musical performance data, and there are many types of MIDI message. For example, information indicating “which key was played how strongly” is transmitted as a Note message.

The way that a device responds when it receives each type of MIDI message (i.e., how it produces sound, etc.) will depend on the specifications of that device. This means that if the receiving device is not able to perform the function requested by the incoming message, the musical result will not be what you expected.

The main types of MIDI message received by this unit are as follows.

* MIDI messages for which reception capability is required by the GM system (level 1) are marked by a ☆ sign.

○ Note messages ☆

These messages convey notes played on the keyboard. They include the following information.

- Note number : a number indicating the note (key) that was pressed or released
- Note on : data indicating that the note (key) was pressed
- Note off : data indicating that the note (key) was released
- Velocity : a number indicating how strongly the note (key) was pressed

Note numbers are a number from 0 — 127 which indicate the keyboard key position, with middle C (C4) as note number 60.

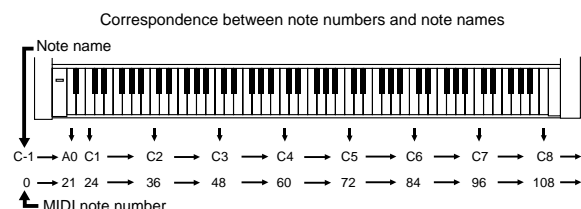

○ Pitch bend ☆

This message conveys the position of the bender lever (or pitch bend wheel). The pitch will change when this message is received.

○ Bank Select (Control Change number 0 and 32)

○ Program Change ☆

These messages are used to select sounds. Sounds are selected by a Program numbers 1 — 128. On this unit, these messages will select sounds (Instruments). By using Bank Select messages (which are a type of Control Change message), an even wider variety of sounds can be selected (p.126).

These messages can also be used to select Patches (p.41). However if settings have been made to allow Patches to be selected, the program change message for each Part will be ignored.

○ Control Change

These messages control parameters such as modulation and pan. The function of the message is determined by its Control Change number.

Modulation (control change number 1) ☆

This message controls vibrato.

Volume (control change number 7) ☆

This message controls the volume of a Part. When this message is received the volume of a Part will change.

Expression (control change number 11) ☆

This message conveys volume changes. It can be used to add expression during a song.

* The volume of a Part will be affected both by Volume messages (control change 7) and by Expression messages (control change 11). If a value of 0 is received for either of these messages, the Part volume will be 0 and will not rise even if the other message is sent with a higher value. Be aware of this.

Using Volume and Expression

It is convenient to use Volume and Expression in distinct ways, as follows.

Volume : Adjust the volume balance between Parts.

Expression : Create volume changes during a song (crescendo, decrescendo, etc.).

The reason for this differentiation is that if you use only Volume messages to create volume changes during the song, you will have to modify all of the Volume data in the song if you later decide to adjust the volume balance between the Parts. However if you use only Volume at the beginning of the song, and use only Expression during the song, it will be easy to adjust the volume balance between Parts for the entire song simply by modifying the Volume data at the beginning of the song, and the data for changes in dynamics during the song can remain as it was. This is very convenient when, for example, you decide to make a slight change in the balance between the piano and bass when the song is nearly completed.

Pan (control change number 10) ☆

This message controls the stereo position of a Part. (p.27, 35)

Hold (1) (control change number 64) ☆

This message conveys the up/down movements of the damper pedal, causing the currently sounding notes to be sustained. When a message of Hold On is received, notes will be sustained. In the case of decay-type instruments such as a piano, the sound will decay gradually until a Hold Off message is received. In the case of sustain-type instruments such as an organ, the sound will continue sustaining until a Hold Off message is received.

Sostenuto (control change number 66)

The sostenuto pedal on a piano sustains only the notes which were already sounding at the moment the pedal was pressed. The Sostenuto message conveys the movement of this pedal. When Sostenuto On is received, only the notes which were already on at that moment will be sustained. In the case of decay-type instruments such as a piano, the sound will decay gradually until a Sostenuto Off message is received. In the case of sustain-type instruments such as an organ, the sound will continue sustaining until a Sostenuto Off message is received.

Soft (control change number 67)

The soft pedal on a piano softens the tone during the time the pedal is pressed. The Soft message conveys the movement of this pedal. When Soft On is received, the cutoff frequency will be lowered, causing a softer sound. When Soft Off is received, the previous sound will return.

Reverb Send Level (control change number 91)

This message adds a reverb effect to the Part (Reverb Level p.52).

Chorus Send Level (control change number 93)

This message adds a chorus effect to the Part (Chorus Level p.53).

Delay Send Level (control change number 93)

This message adds a delay effect to the Part (Delay Level p.54).

Portamento (control change number 65)**Portamento Time (control change number 5)****Portamento Control (control change number 84)**

Portamento is an effect that creates a smooth change in pitch between the previously played note and the newly played note. When a Portamento message is received, the portamento effect will be turned on or off. Portamento Time controls the speed of the pitch change. Portamento Control specifies the Source Note number (the previously played note).

RPN LSB, MSB (control change number 100/101) ☆**Data Entry (control change number 6/38) ☆**

Since the function of the RPN (Registered Parameter Number) is defined in the MIDI specification, this message can be used between devices of different types. The RPN MSB and LSB messages specify the parameter which is to be modified, and then Data Entry messages can be used to modify the value of that parameter. RPN can be used to adjust Pitch Bend Sensitivity, Master Coarse Tune, and Master Fine Tune.

* *The values modified using RPN messages will not be initialized even if Program Change messages etc. are received to select other sounds.*

NRPN LSB, MSB (control change number 98/99)**Data Entry (control change number 6/38)**

NRPN (Non-registered Parameter Number) messages can be used to modify the values of sound parameters unique to a particular device. The NRPN MSB and LSB messages specify the parameter which is to be modified, and then Data Entry messages can be used to modify the value of that parameter.

Since the GS format defines the function of several NRPN messages, GS compatible application programs can use NRPN messages to modify sound data parameters for Vibrato, Cutoff Frequency, Resonance, and Envelope values.

* *The values modified using NRPN messages will not be initialized even if Program Change messages etc. are received to select other sounds.*

* *With the factory settings, this unit will ignore NRPN messages. After a GS Reset message is received, NRPN messages will be received. You can also turn Rx.NRPN on (NRPN Receive Switch, p.141) either from the front panel or by using exclusive messages, so that NRPN messages will be received.*

○ Aftertouch (Channel Pressure only) ☆

Aftertouch is a message which conveys the pressure applied to the keyboard after playing a note, so that this information can be used to control various aspects of the sound. There are two types of aftertouch message; Polyphonic Key Pressure which is transmitted separately for each note, and Channel Key Pressure which is transmitted as one value that affects all notes on the specified MIDI channel.

* *With the factory settings, Aftertouch messages will have no effect when received by this unit. In order for Aftertouch messages to do something, you need to set Aftertouch-related parameters. (p.30).*

○ All Sounds Off

This message completely turns off the sound of all currently-sounding notes. The sound of the specified channel will be forcibly turned off.

○ All Notes Off ☆

This message causes a Note Off to be sent to each note of the specified channel that is currently on. However if Hold 1 or Sostenuato are on, the sound will continue until these are turned off.

○ Reset All Controllers ☆

This message returns controller values to their initial settings. The following controller values for the specified channel will be reset to their initial values.

Controller	Initial value
Pitch Bend	0 (center)
Polyphonic Key Pressure	0 (minimum)
Channel Pressure	0 (minimum)
Modulation	0 (minimum)
Expression	127 (maximum)
Hold	0 (off)
Portamento	0 (off)
Soft	0 (off)
Sostenuato	0 (off)
RPN	number unset
NRPN	number unset

* Parameter values that were modified using RPN or NRPN will not change even when a Reset All Controller message is received.

○ Active Sensing

This message is used to check for broken MIDI connections, such as MIDI connectors that have been pulled out or MIDI cables that have been broken. This unit transmits Active Sensing messages from MIDI OUT at specific intervals. Once an Active Sensing message is received at MIDI IN, Active Sensing monitoring will begin, and if an Active Sensing message fails to arrive for more than 420 msec, it is assumed that the cable has been disconnected. If this happens, all currently sounding notes will be turned off, the same procedure will be executed as if a Reset All Controllers message was received, and Active Sensing monitoring will stop.

○ System Exclusive messages

Exclusive messages are used to control functions which are unique to specific devices. Although Universal System Exclusive messages can be used even between devices of different manufacturers, most exclusive messages cannot be used between devices of different types or different manufacturers.

In order to recognize the device for which the data is intended, Roland exclusive messages contain a manufacturer ID, device ID and model ID.

This unit exclusive messages use two model IDs; 42H for GS format, and 45H for SC-55 (88). The two numbers are used depending on the parameter you wish to modify. Be aware that if the appropriate ID number is not used, data will not be transferred. (p.134)

GM System On ☆ (Universal System Exclusive)

When GM System On is received, the unit will be set to the basic GM settings. Also, NRPN Bank Select messages will no longer be received after GM System On is received. The beginning of song data bearing the GM logo contains a GM System On message. This means that if you playback the data from the beginning, the sound generator device will be automatically initialized to the basic settings.

GS Reset (GS Format System Exclusive)

When GS Reset is received, the unit will be set to the basic GS settings. Also, NRPN messages specified in the GS format can be received after GS Reset is received. The beginning of song data bearing the GS logo contains a GS System Reset message. This means that if you playback the data from the beginning, the sound generator device will be automatically initialized to the basic settings.

Master Volume (Universal System Exclusive)

This is an exclusive message common to all MIDI devices that controls the master volume of all Parts.

Other exclusive messages

This unit can receive GS format exclusive messages (model ID 42H) that are common to all GS sound generators. This unit can also use exclusive messages (model ID 45H) that are especially for the SC-55 (88). Exclusive messages can be used to store this unit settings or to make fine adjustments to parameters.

For details of the exclusive message transmitted and received by this unit, refer to the explanation on p.191 and following.

■ Device ID number settings

The Device ID number is an identification number used when transmitting and receiving exclusive messages (p.133). This unit receives exclusive messages only if its own device ID number matches the device ID number of the message. This means that if you wish to transmit exclusive messages between devices, you must make sure that their device ID numbers match.

The device ID number is a number from 1 — 32. With the factory settings the number is 17.

- * If you wish to playback Roland SMF music data, be sure that the device ID number is set to 17. If it is not, playback will not be correct.
- * It is not possible to specify the device ID number separately for individual Parts.

How to make settings

1. Press [ALL] to make the button indicator light.
2. Simultaneously press both the PART[I]/[r] buttons.
3. Use [u]/[d] to select "Device ID".



4. Use INSTRUMENT[I]/[r] to modify the device ID number.
5. When you finish making settings, simultaneously press both PART[I]/[r] buttons to end the procedure.

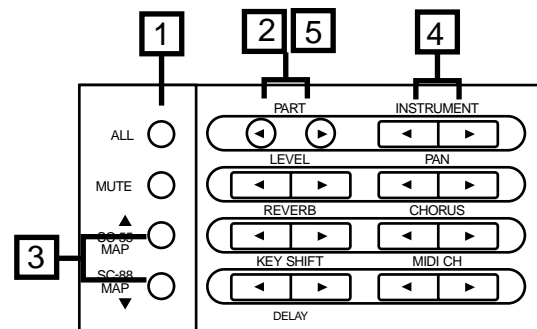

About MIDI implementation charts

MIDI allows many different types of device to be connected, but in some cases there will be types of message which cannot be conveyed meaningfully. For example if you wish to use keyboard aftertouch to control the sound but the sound generator connected to the keyboard does not receive aftertouch messages, you will not get the musical result you intend. In this way, only messages that are used by both devices will actually be conveyed.

The MIDI specification requires that the owner's manual for each MIDI device include a "MIDI Implementation Chart" (p.209) that shows the types of MIDI message which are actually transmitted and received by a device. Place the transmit column of the transmitting device's implementation chart side by side with the receive column of the receiving device's implementation chart. Messages which are marked as "O" in both charts can be conveyed successfully. If either chart shows a "X" for a certain type of message, that message cannot be conveyed.

For your reference, the data format for exclusive messages and other details of this unit MIDI implementation are given on p.188 and following.

■ MIDI message routing settings and switches

This unit provides various parameters that determine how incoming MIDI messages are passed to the Parts. For some types of MIDI message, a switch is provided to turn reception on or off. These parameters can be classified as “Switches which apply to all Parts” or “Switches which can be set individually for each Part.”

[1] Switches which apply to all Parts (A)

IN B Sel.	(IN B Select) Front/Rear
OUT/THRU	(MIDI OUT/THRU Select) OUT/THRU
In Mode	(Input Modes) Standard, X-connect, Merge → A, Merge → B, A only
Rx Sys. Mode	(System Mode Set Receive switch) On, Off

* After modifying the setting of the IN B Sel., OUT/THRU, or In Mode parameters, you must turn the power on once again. New settings of these parameters become valid when the power is turned on.

● Procedure

1. Simultaneously press [u] and [d].
2. Use [u] [d] to select the parameters you wish to set.



3. Use INSTRUMENT [l] [r] to set the value.
4. When you have set the value, simultaneously press [u] and [d] to end the procedure.
5. Turn on the power again. (Except when you have selected Rx Sys. Mode.)

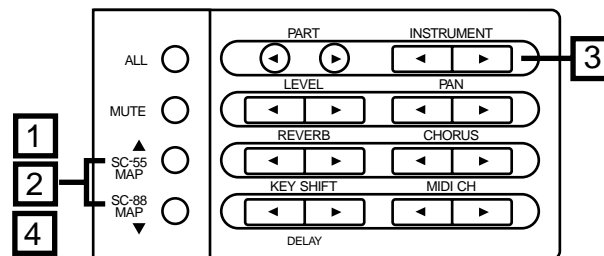

● How each parameter works

○ IN B Sel. (IN B Select) Front/Rear

This unit has two MIDI IN B connectors, one on the front panel and another on the rear panel. If the IN B Sel. parameter is set to Front, the front panel MIDI IN B can be used. If the IN B Sel. parameter is set to Rear, the rear panel MIDI IN B can be used. It is not possible to use both the front and the rear MIDI IN B connectors simultaneously.

<Set to Front>

<Set to Rear>

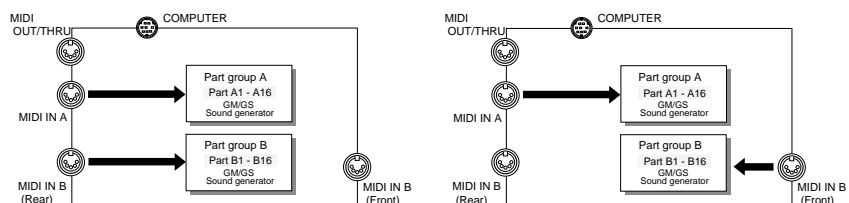

○ OUT/THRU (MIDI OUT/THRU Select) OUT/THRU

The MIDI OUT/THRU connector on the rear panel of this unit can function either as a MIDI OUT or a MIDI THRU. When the OUT/THRU select is set to OUT the connector will function as MIDI OUT, and when set to THRU it will function as MIDI THRU.

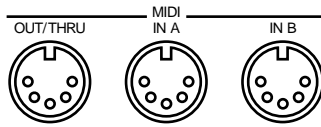

If THRU is selected, data received at MIDI IN A will be retransmitted from the MIDI OUT/THRU connector. Data received at MIDI IN B will never be “thru-ed”, regardless of the THRU setting, and regardless of the setting for In Mode.

If OUT is selected, exclusive data or data received at the computer connector can be transmitted from the MIDI OUT/THRU connector. (p.107, 123)

When the COMPUTER switch is set to MIDI

MIDI OUT/THRU Select : OUT

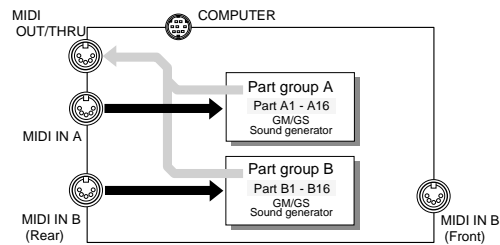

MIDI OUT/THRU Select : THRU

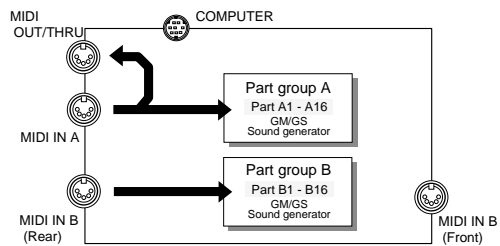

When the COMPUTER switch is set to PC-1, PC-2 or Mac

MIDI OUT/THRU Select : OUT

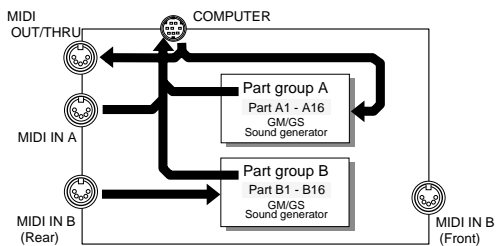

MIDI OUT/THRU Select : THRU

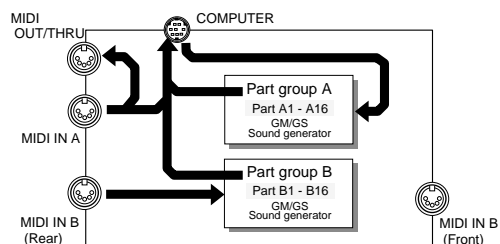

○ In Mode (Input Modes)

Standard, X-connect, Merge → A, Merge → B, A only

With the factory settings, MIDI messages received at MIDI IN A are passed to Group A Parts, and MIDI messages received at MIDI IN B are passed to Group B Parts. In normal circumstances, there is no need to change the standard setting, but it is also possible to change the MIDI signal in the following. (diagram on the following page)

Standard

MIDI messages received at MIDI IN A are passed to Group A Parts, and MIDI messages received at MIDI IN B are passed to Group B Parts. Standard is the factory setting.

X-connect (Cross connect)

This reverses the handling of Standard. MIDI messages received at MIDI IN A are passed to Group B Parts, and MIDI messages received at MIDI IN B are passed to Group A Parts.

Merge → A

MIDI messages received at either MIDI IN A or MIDI IN B are sent to Group A Parts. MIDI messages are not sent to Group B Parts, so they will not sound. For example, you might use this setting when you wish to play Group A Parts simultaneously from a MIDI keyboard and from a MIDI sequencer.

Merge → B

This reverses the handling of Merge → A. MIDI messages received at either MIDI IN A or MIDI IN B are sent to Group B Parts. MIDI messages are not sent to Group A Parts, so they will not sound.

A only

When using the Roland Super MPU (MIDI Processing Unit: two MIDI OUTs), some software will transmit the same data to both of this unit's MIDI IN connectors. This will cause two Parts to sound in unison, causing an unnatural effect. In such a case, do not use both MIDI INs. Either disconnect one of the MIDI cables, or use the preceding procedure to set to A only. When A only, data received at MIDI IN B will be ignored.

* *Be aware that if the computer switch on the rear panel of this unit is set to either PC-1, PC-2 or Mac, MIDI data received at MIDI IN A will not be sent to the Parts (the sound generator), but will be sent through the computer connector to the computer (p.123).*

* *The data sent from the computer through the computer connector will be treated as received from MIDI IN A, and will be passed to the various Parts according to the Input Modes setting.*

○ Rx Sys. Mode (System Mode Set Receive Switch): On/Off

The selection of Single Module Mode or Double Module Mode (p.116) is called the System Mode. The Rx Sys. Mode setting is the receive switch for MIDI messages (System Mode Set p.194) that select the System Mode. If Rx Sys Mode is turned Off, the mode will not change even if System Mode Set messages are received. If Rx Sys Mode is turned On, the mode will change.

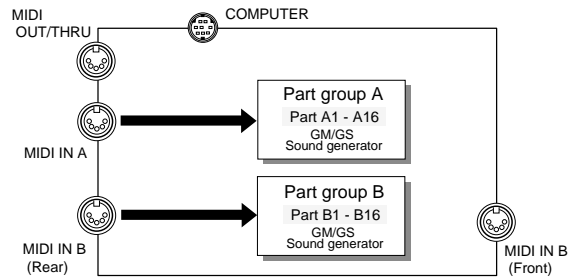

Standard

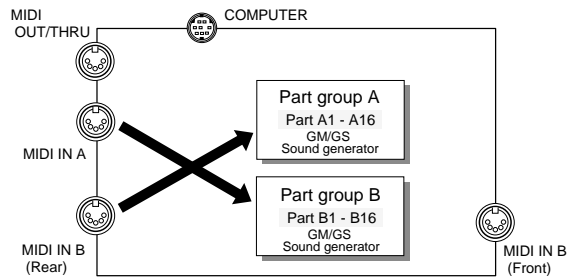

**X-connect
(Cross connect)**

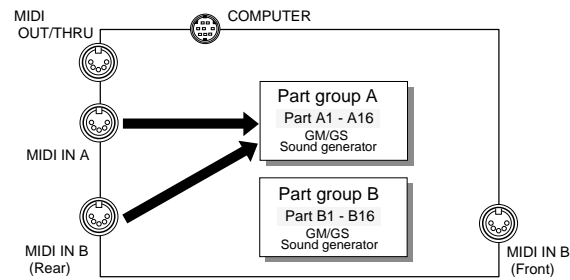

Merge ->A

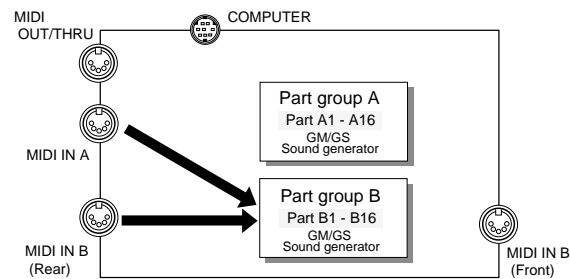

Merge ->B

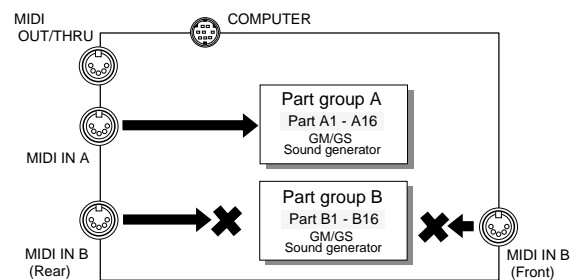

A only

[2] Switches which apply to all Parts (B)

MUTE Lock (Mute Lock) On/Off
EQ Lock (Equalizer Lock) On/Off
Rx GM On (GM System On Receive Switch) On/Off
Rx GS On (GS Reset Receive Switch) On/Off

● Procedure

1. Press [ALL] to make the button indicator light.
2. Simultaneously press both the PART [l] [r] buttons.
3. Press either [u] or [d] to select the parameter you wish to set.

```
PART  INSTRUMENT
ALL >Rx GS Reset: On
LEVEL PAN :
+000 0 :
```

4. Use the INSTRUMENT [l] [r] buttons to set the value.

```
PART  INSTRUMENT
ALL >Rx GS Reset: Off
LEVEL PAN :
+000 0 :
```

5. When you finish making settings, simultaneously press both the PART [l] [r] buttons to exit the procedure.

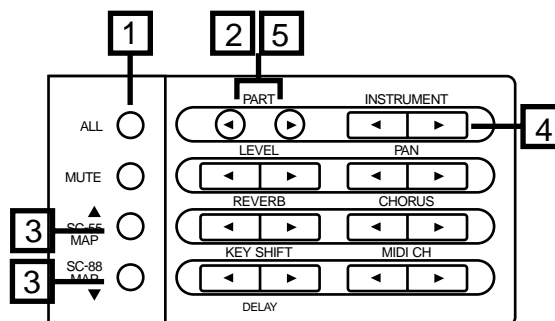

● How each switches works

○ MUTE Lock (Mute Lock) On/Off

When you once again playback a song that was previously played back, Part Mute settings (p.27) are sometimes defeated. This is because the beginning of the song data contains a message that causes this unit to reset to initial values (GM System On / GS Reset p.133). If MUTE Lock is turned on, muting will not be turned off even when GS Reset or GM System On is received, so there will be no need for you to remake mute settings. This is convenient when, for example, you are repeatedly playing back a song with a certain Part muted so that you can play that Part yourself.

* *Regardless of the MUTE Lock setting, All Mute (p.35) will not be defeated when GS Reset or GM System On are received.*

○ EQ Lock (Equalizer Lock) On/Off

When a GS Reset or GM System On message is received, the equalizer settings will be restored to the factory settings (initialized). If EQ Lock is turned on, this will not occur.

○ Rx GM On (GM System On Receive Switch) On/Off

○ Rx GS On (GS Reset Receive Switch) On/Off

GM System On and GS Reset (p.133) are MIDI exclusive messages that are included in the beginning of song data bearing the GM or GS logo. When song data is played back from the beginning, these messages cause the sound generator parameters to be reset to basic values so that playback will be correct. Thus, when playing back song data bearing the GM or GS logo, you should leave these parameters on. If these parameters are turned off, GM System On and GS Reset messages will be ignored.

When you play the General MIDI Score data, be sure to set the General MIDI System On Switch to ON and the Exclusive Receiving Switch to ON .

When you play Roland SMF Music data, be sure to set the Device ID number (p.134) to 17, the GS Reset Receiving Switch to ON .

The default settings are as above.

[3] Switches which can be set individually for each Part

○ Rx Bank Sel (Bank Select Receive Switch) On/Off

To remotely select this unit sounds from another MIDI device, you can send Bank Select messages and Program Change messages to this unit. If Rx Bank Sel is turned on, these MIDI messages can select Variation sounds (p.20) and User sounds (p.96). If this parameter is turned off, bank select messages will be ignored, meaning that MIDI messages cannot select Variation sounds or User sounds (they will select Capital sounds). If this parameter is turned off, a “_” will be displayed between the instrument number and the Instrument name.

For details on using MIDI messages to select sounds, refer to p.126.



○ Rx NRPN (NRPN Receive Switch) On/Off

NRPN (Non-registered Parameter Number p.132) messages allow you to modify vibrato, filter and envelope values (p.32) via MIDI. If Rx NRPN is on, these sound parameters can be modified by MIDI messages. If Rx NRPN is off, this will not be possible.

- * When GM System On is received, Bank Select Receive Switch and NRPN Receive Switch will be turned off.
- * When GS Reset is received, Bank Select Receive Switch and NRPN Receive Switch will be turned on.

● Procedure

1. **Make sure that the [ALL] indicator is dark.**
If it is lit, press the [ALL] button to turn it off.
2. **Simultaneously press both the PART [l] [r] buttons.**
3. **Use PART [l] [r] to select the Part whose setting you wish to modify.**
4. **Press [u] or [d] to select the parameters you wish to set.**



5. **Use INSTRUMENT [l] [r] to turn on or off.**
6. **When you finish making settings, simultaneously press both the PART [l] [r] buttons to end the procedure.**

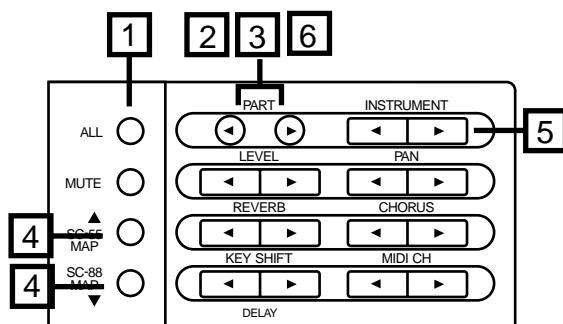

● Using NRPNs with GS Sound Modules

Included within the various types of Control Changes (often abbreviated as "CC") is an extended range known as NRPNs (non-registered parameter numbers). The NRPNs can be used with GS sound modules to alter various sound parameters, such as those for the vibrato, filters, and envelopes. There are distinct advantages to using Control Changes rather than Exclusive messages when wishing to modify sounds. They are not as complicated, they are easier to handle, and they do not require a large amount of data (p.132, 189). Such Control Change messages include a number (the Control Number) which specifies the type of function that is to be controlled.

The MIDI specifications do not define any specific functions which can be set using NRPNs. This is because the NRPNs are intended to serve as a flexible range of controls which can be assigned whatever parameters are required for a specific device in order to achieve the desired changes in its sounds, or enhance its expressive capabilities. In contrast, there is another type of extended form of control known as an RPN (registered parameter number). As their name suggests, RPN functions are all defined (registered) within the MIDI specifications (p.189).

When using an NRPN, the function (sound parameter) being dealt with needs to be specified by means of the numeric values that are supplied for the NRPN MSB (Controller No. 99) and NRPN LSB (Controller No. 98). By then sending the appropriate value for Data Entry (Controller No. 6), the change in the specified sound parameter is accomplished.

Note that instead of the hexadecimal notation that is used within the "MIDI Implementation" (p.189), the numbers for the combinations of values for NRPNs that appear in the chart below have all been converted to decimal. (Note also that these NRPNs are specific only to GS sound modules.)

NRPN MSB	NRPN LSB	Range	Function
1	8	0-64-127	Vibrato Rate *1 (p.32)
1	9	0-64-127	Vibrato Depth *1 (p.32)
1	10	0-64-127	Vibrato Delay *1 (p.32)
1	32	0-64-127	TVF Cutoff Frequency *1 (p.33)
1	33	0-64-127	TVF Resonance *1 (p.33)
1	99	0-64-127	TVF&TVA Envelope Attack Time *1 (p.33)
1	100	0-64-127	TVF&TVA Envelope Decay Time *1 (p.33)
1	102	0-64-127	TVF&TVA Envelope Release Time *1 (p.33)
24	rr	0-64-127	Drum Instrument Pitch Coarse *1 Alters the pitch of individual percussion instruments in the drum Part.
26	rr	0-127	Drum Instrument TVA Level Alters the volume of individual percussion instruments in the drum Part.
28	rr	0,1-64-127	Drum Instrument Pan Alters the panning for individual percussion instruments in the Drum Part. A setting of "0" provides random panning, while "1" selects the leftmost position, "64" the center, and "127" places it at the rightmost position.
29	rr	0-127	Drum Instrument Reverb Send Level Sets the reverb depth for individual percussion instruments in the Drum Part.
30	rr	0-127	Drum Instrument Chorus Send Level Sets the chorus depth for individual percussion instruments in the Drum Part.
31	rr	0-127	Drum Instrument Delay Send Level Determines the amount of delay for individual percussion instruments in the Drum Part (SC-88/this unit only)

For example, let's say that you want to alter the TVF Cutoff Frequency. First, you need to assert that it is the TVF Cutoff Frequency that you wish to control by sending the appropriate NRPN MSB and NRPN LSB combination.

The value for Controller No. 99 is the NRPN MSB, and that for Controller No. 98 is the NRPN LSB.

So, you would transmit these values:

Controller No. 99: 1

Controller No. 98: 32

The unit has thus been made aware that it is the TVF Cutoff Frequency that you are going to change. To go ahead and make the actual change, you would then use the Data Entry Control Change message to supply the new value (**xx**) for the TVF Cutoff Frequency.

Thus, you would send:

Controller No. 6: xx

As a result of transmitting the above three controller values, the TVF Cutoff Frequency will have been altered, and the timbre of the instrument selected for that Part should sound differently.

After altering sound parameters using an NRPN, we recommend that you make a habit of asserting a "null" by sending the RPN values shown below. This will tell the unit that you are finished working with the parameter that has been specified, and that it should stop waiting for any further new values for that parameter. (It cancels the standing request for change in a particular NRPN or RPN.) This way you can avoid having unexpected changes made if any unintended Data Entry values get sent afterwards.

Controller No. 101: 127

Controller No. 100: 127

For the "NRPN LSB rr" value, you need to supply the value which corresponds to the note number of the particular percussion instrument that you want to address (these numbers can be found in the Drum Set Chart at the rear of the manual → p.164).

For example, let's say that you want to set the High Bongo so that no reverb will be applied to it. This instrument is assigned note number 60 (middle C), and is contained in the Standard Set 1 Drum Set.

To accomplish this you would transmit these values:

Controller No. 99: 29

Controller No. 98: 60

Controller No. 6: 0

Note that these MIDI messages need to be sent in the order listed above.

Parameters marked with *1 in the chart at left can be altered in a relative manner, with a value of "0" being the default value. Depending on the particular sound you are working with, the type of change available will be different (in some cases you may not even notice any change). Also, the range of change will vary.

You may need to consult the manual that came with your equipment or software for details on how to properly input and transmit Control Change messages. Note, though, that some devices may only allow you to work with a limited range of controller numbers.

Make sure that you always follow the order shown above when transmitting RPN, NRPN, and Data Entry data. Be careful, since if you insert a multiple number of MIDI messages at the same point in time (or in very close range of each other) when using some types of music software, the messages can sometimes be sent out in an order different than originally intended. To avoid problems, always allow sufficient space between adjacent messages (at least 1 tick at 96 TPQN, and 5 ticks at 480 TPQN).

* TPQN: Ticks Per Quarter Note

* Any value which has been imposed by means of an NRPN will not be initialized even when a different sound is changed to in compliance with a received Program Change. Settings which have been made using NRPNs can only be initialized by sending a GS Reset, or by performing a GS Initialization (p.118).

* At the factory default settings, this unit will not respond to NRPN messages. However, after a GS Reset has been received it will recognize NRPNs. Alternately, you can enable recognition of NRPNs by turning on "Rx.NRPN" (NRPN reception switch p.141), either by using the panel buttons, or through Exclusive messages.

● When song data plays back with the wrong sounds

When song data created using the SC-55 or the SC-155 is played back by this unit, the sounds that were intended may not be selected. This can occur for one of the following two reasons.

1. The wrong Variation number was selected

When a Variation number for which sounds do not exist is selected on this unit, the display will show a message of No INSTRUMENT (or for the Drum Part, No DRUM SET). Even if the relevant Part is not displayed, this message will be displayed briefly when any Part receives such data.

The data which specifies sounds is usually placed in the beginning of the song data, so check whether this message appears when the song data starts. If this message appears, it is possible that a control change Bank Select message (or for the Drum Part, a program change) within the song is incorrect. (p.126) Refer to the instrument list (p.154), and modify the data value so that an existing sound is selected.

2. The wrong sound map was selected

On this unit, the lower byte (LSB) of a control change Bank Select message (control change 32) can be used to switch sound maps (p.126).

Control Change 32 values

- 00: The map selected by the panel buttons will be used.
- 01: The SC-55 map will be selected.
- 02: The SC-88 map will be selected.
- 03: The Native map will be selected.

If values other than these are transmitted to this unit, a map for which this unit has no sounds will be selected, so a message of No INSTRUMENT will appear. In the case of the SC-55/155/55mkII, the LSB of this Bank Select message is ignored, so sound selection will not be affected regardless of the value that is transmitted. However since Bank Select messages are used as a pair of upper and lower values (MSB and LSB), it is best to input 00 as the lower value (LSB) in your song data.

● Using screen display data for the SC-55 series

○ About screen display data

The level indicator area in the center of the SC-55/55mkII/SC-88/VL/Pro display (bar display) is able to display 16 x 16 dot graphics that are transmitted to it as exclusive messages. By transmitting this data together with the song data, you can make the display change as the song progresses.

The SC-88/VL/Pro can hold 10 pages of display data. Exclusive messages can be used to display a specific page, and to adjust the duration for which each page will be displayed (p.193).

Also, text can be displayed in the INSTRUMENT display area, allowing song titles or lyrics to be displayed.

Even display data for the SC-55/55mkII can be used without change to produce the same display. In this case, the data will be displayed as the first page of the 10 pages.

○ Frame Draw function (p.110)

The SC-88/Pro has a Frame Draw function. This function allows you to create display data for each page using the front panel buttons, and to transmit the data you create as an exclusive message. By using this to create data in the appropriate sequence and timing, you can create display data with movement.

● How to use a Part other than Part 10 as a Drum Part, so that two Drum Sets can be used simultaneously

○ About the Part mode

Each Part 1--16 can be used either for normal sounds (Normal Part) or for a drum set (Drum Part). This selection is made by the Part Mode setting. (p.27)

The mode of a Drum Part can be either Drum1 or Drum2. Since the same Drum Set will automatically be selected for Parts that have the same Part Mode, this means that up to 2 types of drum set can be used simultaneously.

For example if you set the Part Mode of Part 10 and Part 11 respectively to Drum1 and Drum2, you could select STANDARD1 Set for Part 10 and JAZZ Set for Part 11. If the Part Mode of both Parts 10 and 11 were set to Drum1, selecting STANDARD1 Set for Part 10 would automatically select STANDARD1 Set for Part 11 as well.

○ Settings via MIDI

To set the Part Mode using MIDI messages, you need to use system exclusive messages.

For example if you wish to set the Part Mode of Part 11 to Drum2, transmit the following message. (p.197)

```
F0 41 10 42 12 40 1A 15 02 0F F7
```

```
10 : Device ID (17)
```

```
40 1A 15 : Address (USE FOR RHYTHM PART of Part 11)
```

```
02 : Data (Part Mode Drum2)
```

To select a Drum Set after setting the Part Mode, transmit a program change to Part 11.

● Using Aftertouch

First connect a device that is able to transmit aftertouch messages to this unit. Be aware that some MIDI keyboards are not able to transmit aftertouch messages.

When this unit receives aftertouch messages, the way in which it responds will depend on its settings. With the factory settings or immediately after this unit has been initialized by a GS Reset etc., aftertouch messages will have no effect, so you will need to change the settings if you want aftertouch to do something.

Aftertouch parameters are divided into the following two groups.

• Channel aftertouch (CAf):

These messages apply an effect to the entire Part of a given channel. For example if you hold down a "C-E-G" chord and then press strongly on just the "C" note, the effect will apply to all notes "C-E-G."

• Polyphonic aftertouch (PAf):

These messages apply an effect independently for each note number. For example if you hold down a "C-E-G" chord and then press strongly on just the "C" note, the effect will apply only to the "C" note.

Of the Channel Aftertouch parameters, the following seven can be set from the panel (p.30).

CAf Range / CAf Cutoff / CAf Amp / CAf LFO Rate / CAf LFO Pitch / CAf LFO TVF / CAf LFO TVA

The other parameters (CAf: 7 types / PAf: 11 types) can be set by transmitting exclusive messages from a sequencer or computer. For details on the messages for these parameters, refer to MIDI Implementation p.198.

● **Using MIDI to control the depth of a System Effect**

○ **Reverb / Chorus / Delay**

The depth of the System effects Reverb / Chorus / Delay can be adjusted for each Part using control change messages (p.132)

Reverb Send Level (Controller number 91)
Chorus Send Level (Controller number 93)
Delay Send Level (Controller number 94)

The Reverb / Chorus / Delay effects use a portion of the sound from each Part to create a new effect sound (reverberance, etc.) which can then be added to the original sound.

The above three parameters control the amount of the sound (signal) of each Part that will be sent to the effect unit. Higher settings will increase the amount of the signal that is sent to the effect unit, causing more effect sound to be produced. The result is that the effect will be deeper.

○ **Equalizer**

The equalizer modifies the tonal character of the sound. You can specify whether or not the sound of a Part will be passed through the equalizer; i.e., turn the equalizer on/off. Settings are made using exclusive messages, not control change messages.

< Setting example >
Turning the equalizer on for Part 1:
F0 41 10 42 12 40 41 20 01 5E F7

Chapter 8

Appendix

■ Troubleshooting.....	146
■ If a message appears.....	148
■ Computer cable wiring diagrams.....	149
■ Parameter list and operations	150
■ Instrument list.....	154
■ Drum set list	163
■ Effect list.....	176
■ Effect data table	183
■ Preset Patch list	186
■ MIDI implementation	188
■ MIDI Implementation Chart	209
■ INDEX	210
■ Specifications	212

■ Troubleshooting

If the this unit does not function in the way you expect, first check the following points. If this does not resolve the problem, consult your dealer or a nearby Roland Service Station (listed at the end of this manual).

- * *If a message appears during operation, consult the following section "If a message appears."*
- * *If performance is incorrect when playing back song data carrying the GM/GS logo, check the following points.*
 - *That the Device ID is set to 17 (p.134)*
 - *That the GM System On / GS Reset Receive Switch (p.140) is turned on**The above settings are made when this unit is shipped from the factory.*

● **Cannot turn the power on**

- Is the power cable correctly plugged into an outlet?

● **No sound**

- Is the power turned on for the other devices connected to the this unit?
- Is the volume knob turned all the way down?
- Have you incorrectly connected the MIDI IN and OUT connectors? (p.8)
- Can you hear sound through headphones? (Preview the sound p.11) If you can hear sound through headphones, the problem may be that the audio cable transmitting the sound to the other devices is broken or incorrectly connected, or that there is a problem with your mixer/amp/speaker system.
- Do the bar indicators in the display move?
 - (1) If the bar indicators are moving

This unit is receiving MIDI data correctly. Check the volume knob position and the cable connections once again.
 - (2) If the bar indicators are not moving

Is the lowest dot in the bar display turned off?
Turn on the [ALL] button indicator. If all dots are off, the All Mute function is on. Turn off the All Mute function. (p.34)
Turn off the [ALL] button indicator. If some of the dots are off, the Part Mute function is on. Turn off the Part Mute function. (p.25)
- Is the overall volume for all parts turned down? (p.34)
- Has the Expression pedal etc. on a connected MIDI device turned the volume down?
- Are the settings for the OUTPUT1,2 jacks correct? (p.29, 38)
- Is the rear panel Computer switch set to the correct position for the software you are using? (p.120) After changing the position of the Computer switch you must turn power of this unit on.

● **A specific Part does not sound**

- Is the lowest dot in the bar display off? Parts for which this dot is off have been muted. Turn Part Mute off. (p.25)
- Is the volume level of the Part turned down? (p.25)
- Does the MIDI Receive channel of the Part match the MIDI Transmit channel of the connected MIDI device? (p.22)

● **A specific keyboard area does not sound**

- Has the Keyboard Range been set? (p.28)

● **Sound is heard but the bar indicator does not move**

- Are you receiving MIDI messages at MIDI IN B and viewing Part information for Group A? If so, press the PART [I] [r] buttons to display the Parts of Group B. If you press the [ALL] button to make the indicator light, Part information for both Groups A and B will be displayed.

● **Cannot select the desired sound**

- Are you sending an incorrect Program number? (p.126)
- Have you specified the MIDI receive channel of a Patch? (p.41)
- Are you selecting All SC-55 MAP or All SC-88 MAP? (p.35)

-
- **Sound is distorted**
 - Is an effect which distorts the sound being applied? (p.56)
 - If a specific sound or Part is distorted, lower the volume level of that Part. (p.25)
 - If all sounds are distorted, lower the overall volume level of all Parts (p.34), or use the Volume knob to lower the volume level.

 - **Pitch is incorrect**
 - Is the pitch of a specific Part incorrect? (p.28)
 - Is the pitch of all Parts incorrect by a semitone or more? (p.34)
 - Is the pitch of a specific Part incorrect by a semitone or more? (p.25)
 - Has a MIDI Pitch Bend message been received to change the pitch? Return the pitch bend lever or wheel to the central position. Or, transmit a Pitch Bend message with the central value (40 00H).

 - **Sound is wrong**
 - Have you selected another sound after modifying sound parameter settings (filter, etc.)? Restore all sound parameter settings to a value of 0. (p.31)

 - **Sounds are interrupted**
 - If you attempt to play more than 64 voices at once, sounds will be interrupted. (p.24)
 - Is the same data being sent simultaneously to MIDI IN A and MIDI IN B? (p.137)

 - **Able to play only from either MIDI IN A or MIDI IN B**
 - Make sure that the In Mode is set to Standard. (p.137)
 - Is the In Mode set to A Only? (p.137)

 - **Exclusive messages are not received**
 - Does the Device ID number of the transmitted exclusive message match the Device ID number of this unit? (p.134)

 - **This unit does not transmit MIDI data**
 - If you wish to transmit this unit data via the Computer connector, set the Computer switch to PC-1, PC-2 or Mac, depending on the software you are using. (p.120)
 - When the rear panel Computer switch is set to MIDI, this unit will not transmit data from the Computer connector. In this case, data will be transmitted from the MIDI OUT/THRU connector.
 - When the MIDI OUT/THRU select switch is set to THRU, data received at MIDI IN A will be transmitted from MIDI OUT/THRU. (p.136)

 - **MIDI sound sources connected to this unit are not played from a computer or sequencer**
 - Music data received at this unit Computer connector is transmitted from the MIDI OUT/THRU connector, but you need to make the following settings. (p.120, 136)
 - * Set the Computer switch to PC-1, PC-2 or Mac depending on your software
 - * Set MIDI OUT/THRU Select switch to OUT
 - MIDI data received at MIDI IN A is transmitted from the MIDI OUT/THRU connector, but you need to make the following settings (p.120, 136)
 - * Set the Computer switch to MIDI
 - * Set the MIDI OUT/THRU Select switch to THRU

* After changing the setting for IN B Sel., OUT/THRU, or In Mode, the power must be turned on again. These settings will take effect the next time the power is turned on.
-

■ If a message appears

If operation is incorrect or if the data cannot be processed correctly, an error message will appear in the display.

Consult the following list and take the appropriate action.

Battery Low

Cause : The memory backup battery inside this unit has run down.

Action : Consult a nearby Roland Service Station.

Check Sum Error

Cause : The check sum of the received exclusive message is incorrect.

Action : Check the data which was transmitted to this unit, and transmit it once again. Also make sure that the MIDI cable is not broken.

MIDI Buff. Full

Cause : A large amount of MIDI data was received by this unit in a time too short for correct processing to be done.

Action : Check whether a large amount of MIDI data is not being transmitted in a short time.

MIDI Off Line

Cause 1 : It is possible that the power has been turned off for the MIDI device connected to MIDI IN.

Action 1 : The problem is not with this unit. Check the power of the connected MIDI device.

Cause 2 : It is possible that a MIDI cable has been pulled out or broken.

Action 2 : Check the MIDI cables.

No INSTRUMENT

Cause : A sound (Instrument) which this unit does not have has been selected.

Action : The previously selected sound name will be displayed, and that sound will be heard. Carefully refer to the tables on p.154 to 162, and specify the correct bank number and program number.

No DRUM SET

Cause : A Drum Set which this unit does not have has been selected.

Action : The previously selected Drum Set name will be displayed, and that set will sound.

No PATCH

Cause : A Patch which this unit does not have has been selected.

Actcion : The previously selected Patch name will be displayed, and that Patch will sound.

Computer cable wiring diagrams

For Apple Macintosh (Sold separately: RSC-15APL)

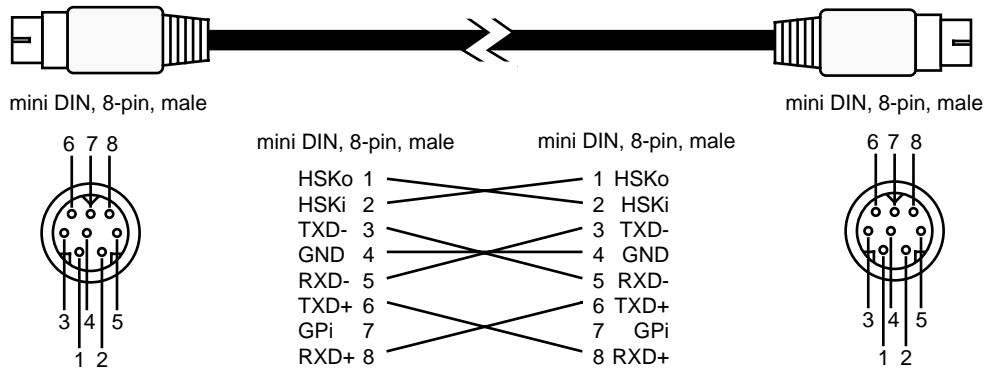

For IBM PC/AT (9-pin) (Sold separately: RSC-15AT)

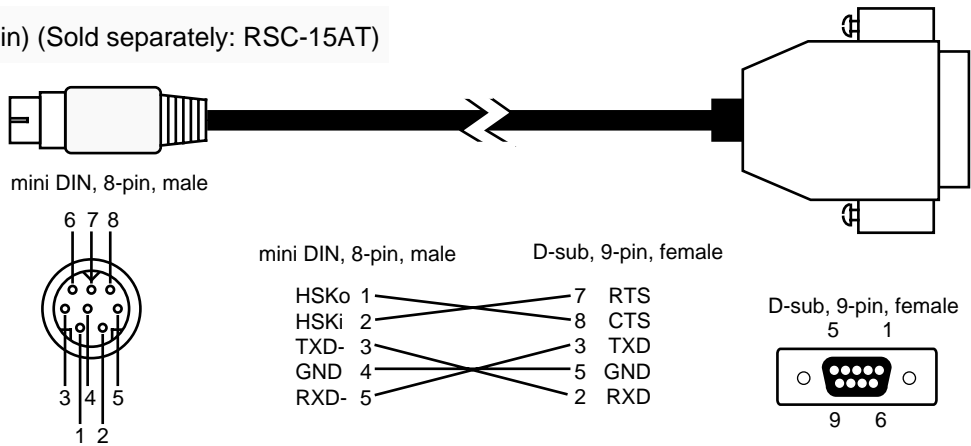

For IBM PC/AT (25-pin)

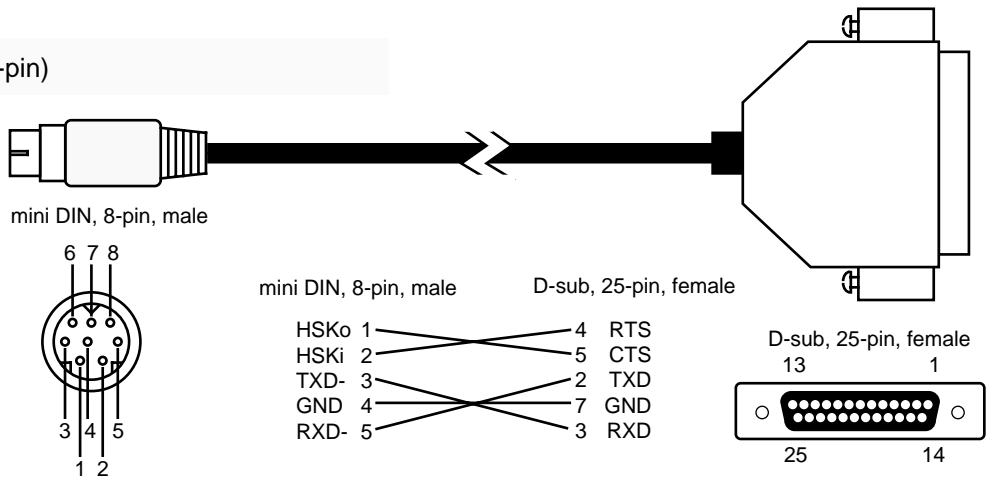

Parameter list and operations

Switching between the ALL display and PART display

ALL/PART Select	ALL/PART	[ALL]:lit/dark	
-----------------	----------	----------------	--

Overall Part settings([ALL]lit)

Level	*	0 - 127	LEVEL[] [r]	P.34
Pan	*	L63 - 0 - R63	PAN[] [r]	
Key Shift	*	-24 - 0 - +24	KEY SHIFT[] [r]	
Mute		Off, On	[MUTE]	
ALL SC-55 Map		Off, On	[SC-55 MAP]	
ALL SC-88 Map		Off, On	[SC-88 MAP]	
Reverb Level	*	0 - 64 - 127	REVERB[] [r]	P.50
Chorus Level	*	0 - 64 - 127	CHORUS[] [r]	
Delay Level	*	0 - 64 - 127	[SC-88 MAP]+DELAY[] [r] or [EFX]: OFF...EFX TYPE [] [r]	
Insertion Effect		Off, On	[EFX]:the indicator light orange...[ON/OFF]	P.56
Select a Patch		1 - 128,U01 - U16	[ALL]lit...INSTRUMENT[] [r]... [ALL]:execute, [MUTE]:cancel	P.40
M. Tune	+ *	415.3 - 440.0 - 466.2Hz	PART[] * [r]...[u][c]...INSTRUMENT[] [r]	P.14
MUTE Lock		Off, On	[SELECT]+[u][c]: Parameter jump	P.139
EQ Lock		Off, On		

Individual Part settings([ALL]dark...PART[] [r]:Select a Part)

Select a Part		A01 - B16	PART[] [r],[ALL]*[PART][] [r] : A, B select	P.18
Select an Instrument sound	*	1 - 128	INSTRUMENT[] [r]	P.18
Select a Variation sound	*	0 - 127	INSTRUMENT[] * [r]...INSTRUMENT[] [r]	P.20
Select a Drum Set	*	1 - 128	INSTRUMENT[] [r]	P.18
Level	*	0 - 100 - 127	LEVEL[] [r]	P.25
Pan	*	Rnd, L63 - 0 - R63	PAN[] [r]	
Key Shift	*	-24 - 0 - +24	KEY SHIFT[] [r]	
Mute	*	Off, On	[MUTE]	
SC-55 Map	*	Off, On	[SC-55 MAP]	
SC-88 Map	*	Off, On	[SC-88 MAP]	
Part Monitor		Off, On	[ALL]*[MUTE]	
Reverb Level	*	0 - 40 - 127	REVERB[] [r]	P.50
Chorus Level	*	0 - 127	CHORUS[] [r]	
Delay Level	*	0 - 127	[SC-88 MAP]+DELAY[] [r] or [EFX]: OFF...EFX TYPE [] [r]	
Insertion Effect	*	Off, On	[EFX]:the indicator light orange...[ON/OFF]	P.56
Part EQ	+ *	Off, On	PART[] * [r]...[u][c]... INSTRUMENT[] [r]:set value	P.26
Part Mode	+ *	Norm, Drum1, 2	[SELECT]+[u][c]: Parameter jump	
M/P Mode	+ *	Mono, Poly		
Fine Tune	+ *	-100- 0.0 - +100		
Velo Depth	+ *	0 - 64 - 127		
Velo Offset	+ *	0 - 64 - 127		
K.Range L	+ *	C-1 - G9		
K.Range H	+ *	C-1 - G9		
CC1 C.Number	+ *	0 - 16 - 95		
OUT Asgn	+ *	OUT-1/2/2L/2R		
S.Tune C-B	+ *	-64 - 0 - +63		
Mod Range	+ *	-24 - 0 - +24		
Mod Cutoff	+ *	-64 - 0 - +63		
Mod Amp	+ *	-64 - 0 - +63		
Mod LFO Rate	+ *	-64 - 0 - +63		
Mod LFO Pch	+ *	0 - 10 - 127		
Mod LFO TVF	+ *	0 - 127		
Mod LFO TVA	+ *	0 - 127		
Bnd Range	+ *	0 - +2 - +24		
Bnd Cutoff	+ *	-64 - 0 - +63		
Bnd Amp	+ *	-64 - 0 - +63		
Bnd LFO Rate	+ *	-64 - 0 - +63		
Bnd LFO Pch	+ *	0 - 127		
Bnd LFO TVF	+ *	0 - 127		
Bnd LFO TVA	+ *	0 - 127		

(Notes)...: continue to the next step

Boldface indicates the factory setting value.

*: Parameters which can be set in a Patch (p.108)

[A]*[B]: simultaneously press both buttons [A] and [B]

[A]+[B]: while holding button [A], press button [B]

+ : Parameters which can be transmitted as Individual data (p.39)

CAf Range	+ *	-24 - 0 - +24		P.26
CAf Cutoff	+ *	-64 - 0 - +63		
CAf Amp	+ *	-64 - 0 - +63		
CAf LFO Rate	+ *	-64 - 0 - +63		
CAf LFO Pch	+ *	0 - 127		
CAf LFO TVF	+ *	0 - 127		
CAf LFO TVA	+ *	0 - 127		
CC1 Range	+ *	-24 - 0 - +24		
CC1 Cutoff	+ *	-64 - 0 - +63		
CC1 Amp	+ *	-64 - 0 - +63		
CC1 LFO Rate	+ *	-64 - 0 - +63		
CC1 LFO Pch	+ *	0 - 127		
CC1 LFO TVF	+ *	0 - 127		
CC1 LFO TVA	+ *	0 - 127		
Vibrato Rate	*	-64 - 0 - +63	[SELECT]... EFX TYPE [I][r]:set value	P.31
Vibrato Depth	*	-64 - 0 - +63	[SELECT]... EFX PARAM [I][r]:set value	
Vibrato Delay	*	-64 - 0 - +63	[SELECT]... EFX VALUE [I][r]:set value	
Cutoff Frequency	*	-64 - 0 - +63	[SELECT]... EFX PARAM [I][r]:set value	
Resonance	*	-64 - 0 - +63	[SELECT]... EFX VALUE [I][r]:set value	
Attack Time	*	-64 - 0 - +63	[SELECT]... EFX TYPE [I][r]:set value	
Decay Time	*	-64 - 0 - +63	[SELECT]... EFX PARAM [I][r]:set value	
Release Time	*	-64 - 0 - +63	[SELECT]... EFX VALUE [I][r]:set value	

● Effects

System Effects	Reverb Type	+ *	Room1, 2, 3, Hall1, 2, Plate, Delay, Panning Delay	[ALL]lit...PART[I][r]...[u][d]... INSTRUMENT[I][r]:set value [SELECT]+[u][d]: Parameter jump	P.51
	Rev Charac.	+ *	0 - 4 - 7		
	Rev Pre-LPF	+ *	0 - 7		
	Rev Level	+ *	0 - 64 - 127		
	Rev Time	+ *	0 - 64 - 127		
	Rev Delay Fb	+ *	0 - 127		
	Rev Pre Delay T	+ *	0 - 127(ms)		
	Chorus Type	+ *	Chorus1, 2, 3, 4, Feedback Chorus, Flanger, Short Delay, Short Delay(FB)		
	Cho Pre-LPF	+ *	0 - 7		
	Cho Level	+ *	0 - 64 - 127		
	Cho Feedback	+ *	0 - 8 - 127		
	Cho Delay	+ *	0 - 80 - 127		
	Cho Rate	+ *	0 - 3 - 127		
	Cho Depth	+ *	0 - 19 - 127		
	Cho→Rev	+ *	0 - 127		
	Cho→Dly	+ *	0 - 127		
	Delay Type	+ *	Delay1, 2, 3, 4, Pan Delay1, 2, 3, 4, Delay To Reverb, Pan Repeat		
	Dly Pre-LPF	+ *	0 - 7		
	Dly Time C	+ *	0.1 - 340 - 1000(ms)		
	Dly T Ratio L	+ *	4 - 500(%)		
Dly T Ratio R	+ *	4 - 500(%)			
Dly Level C	+ *	0 - 127			
Dly Level L	+ *	0 - 127			
Dly Level R	+ *	0 - 127			
Dly Level	+ *	0 - 64 - 127			
Dly Fback	+ *	-64 - +16 - +63			
Dly→Rev	+ *	0 - 127			
Equalizer	Low Freq	+ *	200, 400	[ALL]lit...[SELECT]...	P.48
	High Freq	+ *	3K, 6K	EFX TYPE[I][r]:select Gain/Frequency...	
	Low Gain	+ *	-12 - 0 - +12	EFX PARAM[I][r],EFX VALUE[I][r]:set value...[SELECT]:end	
	High Gain	+ *	-12 - 0 - +12		
Insertion Effects	Type	+ *	0 - 64,1 ^x - 64 ^x	[EFX]...EFX TYPE[I][r]	P.56
	Parameter	+ *	---	[EFX]...EFX PARAM[I][r]... EFX VALUE[I][r]:set value	
	EFX C.Src1/2	+ *	Off,CC1 - 95,CAf,Bend	[ALL]lit...PART[I][r]...[u][d]... INSTRUMENT[I][r]:set value	P.92
	EFX C.Dep1/2	+ *	-100 - 0 - +100	[SELECT]+[u][d]: Parameter jump	

● Drum edit

		PART[][r]:select a Drum Part...INSTRUMENT[][r]:select a Drum Set... [SELECT]*EFX TYPE[]...INSTRUMENT[][r]:select a Drum Instrument...	P.42
Level	0 - 127	LEVEL[][r]	
Pan	Rnd, L63 - R63	PAN[][r]	
Reverb	0 - 127	REVERB[][r]	
Chorus	0 - 127	CHORUS[][r]	
Key Shift	0 - 127	KEY SHIFT[][r]	
Delay	0 - 127	EFX TYPE[][r]	
Assign Group	Non, 1 - 127	MIDI CH[][r]	

● User edit

User Instrument	Edit	[ALL]dark...INSTRUMENT[][r]:select an Instrument [USER INST]*[SELECT]:the indicator light red...[SELECT]... EFX TYPE[][r], EFX PARAM[][r], EFX VALUE[][r]:set value	P.96
	Store	[USER INST]*[SELECT]...INSTRUMENT[][r]:set Instrument number... INSTRUMENT[][r]...INSTRUMENT[][r]:set Variation number... [ALL]:execute, [MUTE]:cancel...[USER INST]:end	P.98
User Patch	Change the Patch name	[ALL]lit...PAN[r]*CHORUS[r]...PART[][r]:move cursor, INSTRUMENT[][r]:select character and symbols, [ALL]:A→a→A, [MUTE]:Space, [u]:0, [d]:&→(→&...PAN[r]*CHORUS[r]:end	P.100
	Store	[ALL]lit...[USER INST]*[SELECT]...INSTRUMENT[][r]:set Patch number... [ALL]:execute, [MUTE]:cancel	P.101
User Effect	Store	[EFX]:the indicator light orange...[EFX]*[ON/OFF]...INSTRUMENT[][r]:set Effect number [ALL]:execute, [MUTE]:cancel	P.99
User Drum	Change the Set name	[ALL]dark...[SELECT]*EFX TYPE[]...PAN[r]*CHORUS[r]... PART[][r]:move cursor, INSTRUMENT[][r]:select character and symbols, [ALL]:A→a→A, [MUTE]:Space, [u]:0, [d]:&→(→&...PAN[r]*CHORUS[r]:end	P.102
	Store an Instrument	[SELECT]*EFX TYPE[]...[USER INST]*[SELECT]... INSTRUMENT[][r]:set Drum Set number... INSTRUMENT[][r]...INSTRUMENT[][r]:set key name... [ALL]:execute, [MUTE]:cancel	P.104
	Store a Set	[SELECT]*EFX TYPE[]...EFX VALUE[][r]...INSTRUMENT[][r]:set Drum Set number... [ALL]:execute, [MUTE]:cancel	P.105

● MIDI-related

MIDI CH	* *1	A01 - A16, A-- B01 - B16, B--	PART[][r]...MIDI CH[][r] KEY SHIFT[r]*MIDI CH[]: A, B select	P.22
IN B Sel.		Rear, Front	[u]*[d]...[u][d]... INSTRUMENT[][r]:set value	P.135
OUT/THRU		OUT, THRU	* Setting becomes valid when the power is turned on	
In Mode		Standard, Xconnect		
Rx Sys Mode		Merge→A, Merge→B, A only		
Rx Sys Mode		Off, On		
Device ID		1 - 17 - 32	[ALL]lit...PART[][r]...[u][d]... INSTRUMENT[][r]:set value	P.134
Rx GM On		Off, On	[SELECT]+[u][d]: Parameter jump	P.139
Rx GS Reset		Off, On		
Rx Bank Sel	+ *	Off, On	[ALL]dark...PART[][r]...[u][d]... INSTRUMENT[][r]:set value	P.141
Rx NRPN	+ *	Off, On	[SELECT]+[u][d]: Parameter jump	
Send a Bulk dump		All, All-U, U, INST, U, DRUM U, EFX, U, Patch, GS A, GS B	[ALL]lit...INSTRUMENT[][r]...INSTRUMENT[][r] [ALL]: execute, [MUTE]: cancel	P.107
Send an Individual data		View Parameter...INSTRUMENT[][r] View Parameter of Insertion Effect...EFX VALUE[][r]		P.108

● System functions

Preview Note	C-1 - A4 - G9	[u]*[d]...[u][d]... INSTRUMENT[][r]:set value	P.36
Preview Velocity	0 - 100 - 127		
Display Type	Type1 - 8		
Peak Hold	Off, Type1 - 3		
LCD Contrast	1 - 8 - 16		
Backup	Off, On		
Sys OUT Mode	Sel/Fix		
Assign Lock	Off, On		
P.Load Init	Off, On		

● Other functions

SC-88-compatibility mode		Off, On	[SELECT]+[ALL]	P.112
Part	Copy	[ALL]dark...PART[I] [r]:select copying source Part...[SELECT]+LEVEL[I]... INSTRUMENT[I] [r]:select copying destination Part...[ALL]:execute, [MUTE]:cancel		P.106
	Initialize	[ALL]dark...[SELECT]+LEVEL[r]... INSTRUMENT[I] [r]:select Part...[ALL]:execute, [MUTE]:cancel		
	Exchange	[ALL]dark...PART[I] [r]:select exchanging source Part...[SELECT]+PAN[I]... INSTRUMENT[I] [r]:select exchanging destination Part...[ALL]:execute, [MUTE]:cancel		
View settings for 32 Parts in the Part display		EFX PARAM[r]*EFX VALUE[I]		P.23
Single Module Mode		[SELECT]+K SHIFT[I]...[ALL]:execute, [MUTE]:cancel		P.116
Double Module Mode		[SELECT]+K SHIFT[r]...[ALL]:execute, [MUTE]:cancel		
Reset to factory settings		[SELECT]+INSTRUMENT[I]*[r]...[ALL]:execute, [MUTE]:cancel		P.118
GM Initialize		[SELECT]+PART[r]...[ALL]:execute, [MUTE]:cancel		P.114
GS Initialize		[SELECT]+INSTRUMENT[r]...[ALL]:execute, [MUTE]:cancel		
CM-64 Sounds		[SELECT]+INSTRUMENT[I]...[ALL]:execute, [MUTE]:cancel		P.114
Draw pictures or characters on the screen (Frame Draw)		EFX TYPE[r]*EFX PARAM[I]...[ALL]:dot on,[MUTE]:dot off [u][d]:move cursor vertically, PART[I] [r]:move cursor horizontally INSTRUMENT[I] [r]:set page, LEVEL[I] [r]:move graphic vertically PAN[I] [r]:move graphic horizontally, INSTRUMENT[I]*[r]:transmit screen data to external device		P.110
	Invert	REVERB[I] [r]...INSTRUMENT[I] [r]:select page...[ALL]:execute, [MUTE]:cancel		
	Copy	K.SHIFT[I] [r]...INSTRUMENT[I] [r]:select page...[ALL]:execute, [MUTE]:cancel		
	Delete	MIDI CH[I] [r]...INSTRUMENT[I] [r]:select page...[ALL]:execute, [MUTE]:cancel		

(Notes)...: continue to the next step

Boldface indicates the factory setting value.

*: Parameters which can be set in a Patch (p.108)

[A]*[B]: simultaneously press both buttons [A] and [B]

[A]+[B]: while holding button [A], press button [B]

+: Parameters which can be transmitted as Individual data (p.39)

*1: A distinction between Group A and B of MIDI channels will not be stored in a Patch. The MIDI channel will be saved as channel "A**" of Group A.

Instrument list

Piano

PC	CC00	Native Map	Voices	SC88 Map	Voices	SC55 Map	Voices
001	000	Piano 1	1	Piano 1	1	Piano 1	1
	008	Piano 1w	1	Piano 1w	1	Piano 1w	1
	016	European Pf	1	Piano 1d	1	Piano 1d	1
	024	Piano + Str.	2	-----	-----	-----	
002	000	Piano 2	2	Piano 2	1	Piano 2	1
	008	Piano 2w	2	Piano 2w	1	Piano 2w	1
	016	Dance Piano	2	-----	-----	-----	
003	000	Piano 3	2	Piano 3	1	Piano 3	1
	001	EG+Rhodes 1	2	EG+Rhodes 1	2	-----	
	002	EG+Rhodes 2	2 #	EG+Rhodes 2	2	-----	
	008	Piano 3w	2	Piano 3w	1	Piano 3w	1
004	000	Honky-tonk	2	Honky-tonk	2	Honky-tonk	2
	008	Honky-tonk 2	2	Old Upright	2	HonkyTonk w	2
005	000	E.Piano 1	1	E.Piano 1	2	E.Piano 1	1
	008	St.Soft EP	2 #	St.Soft EP	2	Detuned EP1	2
	009	Cho.E.Piano	2	-----	-----	-----	
	010	SilentRhodes	2	-----	-----	-----	
	016	FM+SA EP	2 #	FM+SA EP	2	E.Piano 1v	2
	017	Dist E.Piano	2	-----	-----	-----	
	024	Wurly	2	60'sE.Piano	1	60s E.Piano	1
	025	Hard Rhodes	2 #	Hard Rhodes	2	-----	
	026	MellowRhodes	2 #	MellwRhodes	2	-----	
006	000	E.Piano 2	2 #	E.Piano 2	2	E.Piano 2	1
	008	Detuned EP 2	2 #	Detuned EP2	2	Detuned EP2	2
	016	St.FM EP	2 #	St.FM EP	2	E.Piano 2v	2
	024	Hard FM EP	2 #	Hard FM EP	2	-----	
007	000	Harpsichord	1 #	Harpsichord	1	Harpsichord	1
	001	Harpsichord2	2	-----	-----	-----	
	008	Coupled Hps.	2 #	Coupled Hps	2 *	Coupled Hps	2
	016	Harpsi.w	1 #	Harpsi.w	1	Harpsi.w	1
	024	Harpsi.o	2 #	Harpsi.o	2	Harpsi.o	2
	032	Synth Harpsi	2	-----	-----	-----	
008	000	Clav.	1 #	Clav.	1	Clav.	1
	008	Comp Clav.	1	-----	-----	-----	
	016	Reso Clav.	1	-----	-----	-----	
	024	Clav.o	2	-----	-----	-----	
	032	Analog Clav.	2	-----	-----	-----	
	033	JP8 Clav. 1	1	-----	-----	-----	
	035	JP8 Clav. 2	1	-----	-----	-----	

Chromatic percussion

009	000	Celesta	1 #	Celesta	1 *	Celesta	1
	001	Pop Celesta	2	-----	-----	-----	
010	000	Glockenspiel	1 #	Glockenspiel	1	Glockenspiel	1
011	000	Music Box	1 #	Music Box	1	Music Box	1
012	000	Vibraphone	1	Vibraphone	1	Vibraphone	1
	001	Pop Vibe.	2	Hard Vibe	2	-----	
	008	Vibraphone w	1	Vib.w	1 *	Vib.w	1
	009	Vibraphones	2	-----	-----	-----	
013	000	Marimba	1 #	Marimba	1	Marimba	1
	008	Marimba w	1 #	Marimba w	1	Marimba w	1

PC : program number(Instrument number)
 CC00 : value of controller number 0 (Bank number, Variation number)
 : : legato-enabled sounds
 Voices : number of voices used by the Instrument
 Remark # : same sounds as SC-88 map
 Remark * : same sound as SC-55 map
 Remark + : a percussive sound which cannot be played melodically. Use near C4 (note number 60).

PC	CC00	Native Map	Voices	SC88 Map	Voices	SC55 Map	Voices
	016	Barafon	1 #	Barafon	1	-----	
	017	Barafon 2	1 #	Barafon 2	1	-----	
	024	Log drum	1 #	Log drum	1	-----	
014	000	Xylophone	1 #	Xylophone	1	Xylophone	1
015	000	Tubular-bell	1 #	Tubularbell	1 *	Tubularbell	1
	008	Church Bell	1 #	Church Bell	1 *	Church Bell	1
	009	Carillon	1 #	Carillon	1 *	Carillon	1
016	000	Santur	1 #	Santur	1 *	Santur	1
	001	Santur 2	2 #	Santur 2	2	-----	
	008	Cimbalom	2 #	Cimbalom	2	-----	
	016	Zither 1	1	-----	-----	-----	
	017	Zither 2	2	-----	-----	-----	
	024	Dulcimer	2	-----	-----	-----	
017	000	Organ 1	2	Organ 1	1	Organ 1	1
	001	Organ 101	2	Organ 101	2	-----	
	008	Trem. Organ	2	DetunedOr.1	2	Detuned Or1	2
	009	Organ.o	2	Organ 109	2	-----	
	016	60's Organ 1	1	60'sOrgan 1	1	60's Organ1	1
	017	60's Organ 2	1	60'sOrgan 2	1	-----	
	018	60's Organ 3	1	60'sOrgan 3	1	-----	
	019	Farf Organ	1	-----	-----	-----	
	024	Cheese Organ	1 #	CheeseOrgan	1	-----	
	025	D-50 Organ	2	-----	-----	-----	
	026	JUNO Organ	2	-----	-----	-----	
	027	Hybrid Organ	2	-----	-----	-----	
	028	VS Organ	2	-----	-----	-----	
	029	Digi Church	2	-----	-----	-----	
	032	70's E.Organ	2	Organ 4	1	Organ 4	2
	033	Even Bar	2 #	Even Bar	2	-----	
	040	Organ Bass	1 #	Organ Bass	1	-----	
	048	5th Organ	2	-----	-----	-----	
018	000	Organ 2	2	Organ 2	1	Organ 2	1
	001	Jazz Organ	2	Organ 201	2	-----	
	002	E.Organ 16+2	2	-----	-----	-----	
	008	Chorus Or.2	2	DetunedOr.2	2	Detuned Or2	2
	009	Octave Organ	2	-----	-----	-----	
	032	Perc.Organ	2	Organ 5	2	Organ 5	2
019	000	Organ 3	2 #	Organ 3	2 *	Organ 3	2
	008	Rotary Org.	1 #	Rotary Org.	1	-----	
	016	Rotary Org.S	1 #	RotaryOrg.S	1	-----	
	017	Rock Organ 1	2	-----	-----	-----	
	018	Rock Organ 2	2	-----	-----	-----	
	024	Rotary Org.F	1 #	RotaryOrg.F	1	-----	
020	000	Church Org.1	1 #	ChurchOrg.1	1	Church Org1	1
	008	Church Org.2	2 #	ChurchOrg.2	2	Church Org2	2
	016	Church Org.3	2 #	ChurchOrg.3	2	Church Org3	2
	024	Organ Flute	1 #	Organ Flute	1	-----	
	032	Trem.Flute	2 #	Trem.Flute	2	-----	
	033	Theater Org.	2	-----	-----	-----	

PC	CC00	Native Map	Voices	SC88 Map	Voices	SC55 Map	Voices	PC	CC00	Native Map	Voices	SC88 Map	Voices	SC55 Map	Voices
021	000	Reed Organ	1 #	Reed Organ	1 *	Reed Organ	1	009	Feedback Gt2	2 #	FeedbackGt2	2	----		
	008	Wind Organ	2	----	----	----		016	Power Guitar	2 #	PowerGuitar	2	----		
022	000	Accordion Fr	1	AccordionFr	1	Accordion F	2	017	Power Gt.2	2	Power Gt.2	2	----		
	008	Accordion lt	1	Accordionlt	2	Accordion l	2	018	5th Dist.	2 #	5th Dist.	2	----		
	009	Dist. Accord	2	----	----	----		024	Rock Rhythm	2 #	Rock Rhythm	2	----		
	016	Cho. Accord	2	----	----	----		025	Rock Rhythm2	2 #	RockRhythm2	2	----		
	024	Hard Accord	2	----	----	----									
	025	Soft Accord	2	----	----	----									
023	000	Harmonica	1	Harmonica	1	Harmonica	1	032	000	Gt.Harmonics	1 #	Gt.Harmonix	1 *	Gt.Harmonix	1
	001	Harmonica 2	1	Harmonica 2	2	----			008	Gt. Feedback	1 #	Gt.Feedback	1 *	Gt.Feedback	1
024	000	Bandoneon	2	Bandoneon	1	Bandoneon	2		009	Gt.Feedback2	2	----	----		
	008	Bandoneon 2	2	----	----	----			016	Ac.Gt.Harmnx	1 #	Ac.Gt.Harm.	1	----	
	016	Bandoneon 3	2	----	----	----			024	E.Bass Harm.	1	----	----		
Guitar								Bass							
025	000	Nylon-str.Gt	2	Nylonstr.Gt	1	Nylon Gt.	1	033	000	Acoustic Bs.	1	AcousticBs.	2	Acoustic Bs	1
	008	Ukulele	1 #	Ukulele	1	Ukulele	1		001	Rockabilly	2	----	----		
	016	Nylon Gt.o	2	Nylon Gt.o	2	Nylon Gt.o	2		008	Wild A.Bass	2	----	----		
	024	Velo Harmnix	1 #	VeloHarmnix	1	----			016	Bass + OHH	2	----	----		
	032	Nylon Gt 2	1	Nylon Gt.2	1	Nylon Gt.2	1	034	000	Fingered Bs.	1	FingeredBs.	1	Fingered Bs	1
	040	Lequint Gt.	1 #	Lequint Gt.	1	----			001	Fingered Bs2	2	FingeredBs2	2	----	
026	000	Steel-str.Gt	1	Steelstr.Gt	1	Steel Gt.	1		002	Jazz Bass	1 #	Jazz Bass	1	----	
	008	12-str.Gt	2	12-str.Gt	2	12-str.Gt	2		003	Jazz Bass 2	2	----	----		
	009	Nylon+Steel	2	Nylon+Steel	2	----			004	Rock Bass	2	----	----		
	016	Mandolin	2 #	Mandolin	2	Mandolin	1		008	ChorusJazzBs	2	----	----		
	017	Mandolin 2	2	----	----	----			016	F.Bass/Harm.	1	----	----		
	018	MandolinTrem	2	----	----	----		035	000	Picked Bass	1	Picked Bass	1	Picked Bass	1
	032	Steel Gt.2	1 #	Steel Gt.2	1	----			001	Picked Bass2	2	----	----		
027	000	Jazz Gt.	1	Jazz Gt.	1 *	Jazz Gt.	1		002	Picked Bass3	2	----	----		
	001	Mellow Gt.	2 #	Mellow Gt.	2	----			003	Picked Bass4	2	----	----		
	008	Pedal Steel	1 #	Pedal Steel	1	Hawaiian Gt	1		008	Muted PickBs	1	MutePickBs.	1	----	
028	000	Clean Gt.	1	Clean Gt.	1	Clean Gt.	1		016	P.Bass/Harm.	1	----	----		
	001	Clean Half	1	----	----	----		036	000	Fretless Bs.	1 #	FretlessBs.	1	Fretless Bs	1
	002	Open Hard 1	2	----	----	----			001	Fretless Bs2	2	FretlessBs2	2	----	
	003	Open Hard 2	1	----	----	----			002	Fretless Bs3	2 #	FretlessBs3	2	----	
	004	JC Clean Gt.	1	----	----	----			003	Fretless Bs4	2 #	FretlessBs4	2	----	
	008	Chorus Gt.	2	Chorus Gt.	2	Chorus Gt.	2		004	Syn Fretless	2 #	SynFretless	2	----	
	009	JC Chorus Gt	2	----	----	----			005	Mr.Smooth	2 #	Mr.Smooth	2	----	
	016	TC FrontPick	1	----	----	----			008	Wood+FlessBs	2	----	----		
	017	TC Rear Pick	1	----	----	----		037	000	Slap Bass 1	1 #	Slap Bass 1	1	Slap Bass 1	1
	018	TC Clean ff	2	----	----	----			001	Slap Pop	1	----	----		
	019	TC Clean 2:	2	----	----	----			008	Reso Slap	1 #	Reso Slap	1	----	
									009	Unison Slap	2	----	----		
029	000	Muted Gt.	1	Muted Gt.	1	Muted Gt.	1	038	000	Slap Bass 2	2 #	Slap Bass 2	2	Slap Bass 2	1
	001	Muted Dis.Gt	1 #	MutedDis.Gt	1	----			008	FM Slap	2	----	----		
	002	TC Muted Gt.	2	----	----	----		039	000	Synth Bass 1	2 #	SynthBass 1	2	Syn.Bass 1	1
	008	Funk Pop	1 #	Funk Pop	1	Funk Gt.	1		001	SynthBass101	1 #	Syn.Bass101	1 *	Syn.Bass101	1
	016	Funk Gt.2	1 #	Funk Gt.2	1	Funk Gt.2	1		002	CS Bass	2	----	----		
030	000	OverdriveGt	2	OverdriveGt	1	OverdriveGt	1		003	JP-4 Bass	1	----	----		
	001	Overdrive 2	2	----	----	----			004	JP-8 Bass	2	----	----		
	002	Overdrive 3	2	----	----	----			005	P5 Bass	1	----	----		
	003	More Drive	2	----	----	----			006	JPMG Bass	2	----	----		
	008	LP OverDrvGt	2	----	----	----			008	Acid Bass	1 #	Acid Bass	1	Syn.Bass 3	1
	009	LP OverDrv:	2	----	----	----			009	TB303 Bass	1 #	TB303 Bass	1	----	
031	000	DistortionGt	2	DistortionGt	1	Dist.Gt.	1		010	Tekno Bass	2 #	Tekno Bass	2	----	
	001	Dist. Gt2 :	2	Dist. Gt2	2	----			011	TB303 Bass 2	1	----	----		
	002	Dazed Guitar	2 #	DazedGuitar	2	----			012	Kicked TB303	2	----	----		
	003	Distortion:	2	----	----	----			013	TB303 Saw Bs	1	----	----		
	004	Dist.Fast :	2	----	----	----			014	Rubber303 Bs	1	----	----		
	008	Feedback Gt.	2 #	FeedbackGt.	2	Feedback Gt	2		015	Reso 303 Bs	1	----	----		
									016	Reso SH Bass	1 #	Reso SHBass	1	----	

PC	CC00	Native Map	Voices	SC88 Map	Voices	SC55 Map	Voices
	017	303 Sqr Bs	1	----		----	
	018	TB303 DistBs	1	----		----	
	024	Arpeggio Bs	1	----		----	
040	000	Synth Bass 2	2 #	SynthBass 2	2	Syn.Bass 2	2
	001	SynthBass201	2 #	Syn.Bass201	2	----	
	002	Modular Bass	2 #	ModularBass	2	----	
	003	Seq Bass	2 #	Seq Bass	2	----	
	004	MG Bass	1	----		----	
	005	Mg Oct Bass 1	2	----		----	
	006	MG Oct Bass2	2	----		----	
	007	MG Blip Bs:	2	----		----	
	008	Beef FM Bass	2 #	Beef FMBass	2	Syn.Bass 4	2
	009	Dly Bass	2	X Wire Bass	2	----	
	010	X Wire Bass	2 #	----		----	
	011	WireStr Bss	2	----		----	
	012	Blip Bass :	2	----		----	
	013	RubberBass 1	2	----		----	
	016	RubberBass 2	2	Rubber Bass	2 *	Rubber Bass	2
	017	SH101 Bass 1	1 #	SH101Bass 1	1	----	
	018	SH101 Bass 2	1 #	SH101Bass 2	1	----	
	019	Smooth Bass	2 #	Smooth Bass	2	----	
	020	SH101 Bass 3	1	----		----	
	021	Spike Bass	1	----		----	
	022	House Bass:	2	----		----	
	023	KG Bass	2	----		----	
	024	Sync Bass	2	----		----	
	025	MG 5th Bass	2	----		----	
	026	RND Bass	2	----		----	
	027	WowMG Bass	2	----		----	
	028	Bubble Bass	2	----		----	

Strings/orchestra

041	000	Violin :	2	Violin	1	Violin	1
	001	Violin Atk:	2	----		----	
	008	Slow Violin	1	Slow Violin	1	Slow Violin	1
042	000	Viola :	2	Viola	1	Viola	1
	001	Viola Atk.:	2	----		----	
043	000	Cello :	2	Cello	1	Cello	1
	001	Cello Atk.:	2	----		----	
044	000	Contrabass	1	Contrabass	1	Contrabass	1
045	000	Tremolo Str	1 #	Tremolo Str	1	Tremolo Str	1
	008	Slow Tremolo	1 #	SlowTremolo	1	----	
	009	Suspense Str	2 #	SuspenseStr	2	----	
046	000	PizzicatoStr	1 #	Pizz. Str.	1	Pizzicato	1
	001	Vcs&Cbs Pizz	2	----		----	
	002	Chamber Pizz	2	----		----	
	003	St.Pizzicato	2	----		----	
	008	Solo Pizz.	1	----		----	
	016	Solo Spic.	1	----		----	
047	000	Harp	1 #	Harp	1	Harp	1
	016	Synth Harp	1	----		----	

PC	CC00	Native Map	Voices	SC88 Map	Voices	SC55 Map	Voices
048	000	Timpani	1 #	Timpani	1	Timpani	1
Ensemble							
049	000	Strings :	2	Strings	1	Strings	1
	001	Bright Str:	1	Strings 2	1	----	
	002	ChamberStr:	2	----		----	
	003	Cello sect.	1	----		----	
	008	Orchestra	2	Orchestra	2	Orchestra	2
	009	Orchestra 2	2	Orchestra 2	2	----	
	010	Tremolo Orch	2 #	TremoloOrch	2	----	
	011	Choir Str.	2	Choir Str.	2	----	
	012	Strings+Horn	2	----		----	
	016	St. Strings	2	St.Strings	2	----	
	024	Velo Strings	2 #	VeloStrings	2	----	
	032	Oct Strings1	2	----		----	
	033	Oct Strings2	2	----		----	
050	000	SlowStrings	1	SlowStrings	1	SlowStrings	1
	001	SlowStrings2	1	Slow Str. 2	1	----	
	008	Legato Str.	2 #	Legato Str.	2	----	
	009	Warm Strings	2 #	WarmStrings	2	----	
	010	St.Slow Str.	2	St.SlowStr.	2	----	
051	000	Syn.Strings1	2	SynStrings1	2	SynStrings1	1
	001	OB Strings	2	OB Strings	2	----	
	002	StackStrings	2	----		----	
	003	JP Strings	2	----		----	
	008	Syn.Strings3	2 #	SynStrings3	2 *	SynStrings3	2
	009	Syn.Strings4	2	----		----	
	016	High Strings	2	----		----	
	017	Hybrid Str.	2	----		----	
	024	Tron Strings	2	----		----	
	025	Noiz Strings	2	----		----	
052	000	Syn.Strings2	2 #	SynStrings2	2 *	SynStrings2	2
	001	Syn.Strings5	2	----		----	
	002	JUNO Strings	2	----		----	
	008	Air Strings	2	----		----	
053	000	Choir Aahs	1	Choir Aahs	1	Choir Aahs	1
	008	St.ChoirAahs	2	St.Choir	2	----	
	009	Melted Choir	2	Mello Choir	2	----	
	010	Church Choir	2	----		----	
	016	Choir Hahs	1	----		----	
	024	Chorus Lahs	1	----		----	
	032	Chorus Aahs	2	ChoirAahs 2	1 *	Choir Aahs2	1
	033	Male Aah+Str	2	----		----	
054	000	Voice Oohs	1 #	Voice Oohs	1 *	Voice Oohs	1
	008	Voice Dahs	1	----		----	
055	000	SynVox	1 #	SynVox	1 *	SynVox	1
	008	Syn.Voice	2 #	Syn.Voice	2	----	
	009	Silent Night	2	----		----	
	016	VP330 Choir	1	----		----	
	017	Vinyl Choir	2	----		----	
056	000	OrchestraHit	2 #	Orch. Hit	2	Orchest.Hit	2
	008	Impact Hit	2 #	Impact Hit	2	----	

PC : program number(*Instrument number*)
CC00 : value of controller number 0 (*Bank number, Variation number*)
 : : legato-enabled sounds
Voices : number of voices used by the *Instrument*
Remark # : same sounds as SC-88 map
*Remark ** : same sound as SC-55 map
Remark + : a percussive sound which cannot be played melodically. Use near C4
 (*note number 60*).

PC	CC00 Native Map	Voices	SC88 Map	Voices	SC55 Map	Voices	PC	CC00 Native Map	Voices	SC88 Map	Voices	SC55 Map	Voices
009	Philly Hit	2 #	Philly Hit	2	----		064	000 SynthBrass 2	2	Syn.Brass 2	2 *	Syn.Brass 2	2
010	Double Hit	2 #	Double Hit	2	----		001	Soft Brass	2	Soft Brass	2	----	
011	Perc.Hit	1	----		----		002	Warm Brass	2	----		----	
012	Shock Wave	2	----		----		008	SynBrass sfz	1	Syn.Brass 4	1 *	Syn.Brass 4	1
016	Lo Fi Rave	2 #	Lo Fi Rave	2	----		009	OB Brass	2	----		----	
017	Techno Hit	1	----		----		010	Reso Brass	2	----		----	
018	Dist.Hit	1	----		----		016	Velo Brass 1	2 #	VeloBrass 1	2	Analog Brs2	2
019	Bam Hit	1	----		----		017	Transbrass	2	VeloBrass 2	2	----	
020	Bit Hit	1	----		----		Reed						
021	Bim Hit	1	----		----		065	000 Soprano Sax	1	Soprano Sax	1	Soprano Sax	1
022	Technorg Hit	1	----		----		008	SopranoExp.	1	----		----	
023	Rave Hit	2	----		----		066	000 Alto Sax	1	Alto Sax	1	Alto Sax	1
024	Strings Hit	2	----		----		008	AltoSax Exp.	1	Hyper Alto	1	----	
025	Stack Hit	2	----		----		009	Grow Sax	1	----		----	
Brass							016	AltoSax + Tp	2	----		----	
057	000 Trumpet	1	Trumpet	1	Trumpet	1	067	000 Tenor Sax	2	Tenor Sax	2	Tenor Sax	1
001	Trumpet 2	1 #	Trumpet 2	1	----		001	Tenor Sax :	2	----		----	
002	Trumpet :	1	----		----		008	BreathyTn.:	1	BreathyTnr.	1	----	
008	Flugel Horn	1 #	Flugel Horn	1	----		009	St.Tenor Sax	2	----		----	
016	4th Trumpets	2	----		----		068	000 Baritone Sax	2	BaritoneSax	1	BaritoneSax	1
024	Bright Tp.	2	Bright Tp.	2	----		001	Bari. Sax :	2	----		----	
025	Warm Tp.	2 #	Warm Tp.	2	----		069	000 Oboe	1	Oboe	1	Oboe	1
032	Syn. Trumpet	1	----		----		008	Oboe Exp.	1	----		----	
058	000 Trombone	1	Trombone	1	Trombone	1	016	Multi Reed	1	----		----	
001	Trombone 2	1	Trombone 2	2 *	Trombone 2	2	070	000 English Horn	1 #	EnglishHorn	1	EnglishHorn	1
002	Twin bones	2	----		----		071	000 Bassoon	1 #	Bassoon	1	Bassoon	1
008	Bs. Trombone	1	----		----		072	000 Clarinet	1	Clarinet	1	Clarinet	1
059	000 Tuba	1 #	Tuba	1	Tuba	1	008	Bs Clarinet	1 #	Bs Clarinet	1	----	
001	Tuba 2	1 #	Tuba 2	1	----		016	Multi Wind	1	----		----	
060	000 MutedTrumpet	1 #	Muted Tp.	1	MuteTrumpet	1	Pipe						
008	Muted Horns	1	----		----		073	000 Piccolo	1 #	Piccolo	1	Piccolo	1
061	000 French Horns	1 #	FrenchHorns	1	French Horn	2	001	Piccolo :	1	----		----	
001	Fr.Horn 2	2 #	Fr.Horn 2	2 *	Fr.Horn 2	2	008	Nay	2	----		----	
002	Horn + Orche	2	----		----		009	Nay Tremolo	2	----		----	
003	Wide FreHrns	2	----		----		016	Di	2	----		----	
008	F.Hrn Slow:	1	Fr.HornSolo	1	----		074	000 Flute	1 #	Flute	1	Flute	1
009	Dual Horns	2	----		----		001	Flute 2 :	1	----		----	
016	Synth Horn	2	Horn Orch	2	----		002	Flute Exp.	1	----		----	
024	F.Horn Rip	1	----		----		003	Flt Travelso	2	----		----	
062	000 Brass 1	2	Brass 1	1 *	Brass 1	1	008	Flute + Vln	2	----		----	
001	Brass ff	1	----		----		016	Tron Flute	1	----		----	
002	Bones Sect.	1	----		----		075	000 Recorder	1 #	Recorder	1 *	Recorder	1
008	Brass 2	2	Brass 2	2	Brass 2	2	076	000 Pan Flute	2 #	Pan Flute	2	Pan Flute	1
009	Brass 3	2	----		----		008	Kawala	2 #	Kawala	2	----	
010	Brass sfz	2	----		----		016	Zampona	2	----		----	
016	Brass Fall	1 #	Brass Fall	1	----		017	Zampona Atk	1	----		----	
017	Trumpet Fall	1	----		----		077	000 Bottle Blow	2 #	Bottle Blow	2	Bottle Blow	2
024	Octave Brass	2	----		----		078	000 Shakuhachi	2 #	Shakuhachi	2 *	Shakuhachi	2
025	Brass + Reed	2	----		----		001	Shakuhachi:	2	----		----	
063	000 SynthBrass1	2	SynthBrass1	2	Syn.Brass 1	2	079	000 Whistle	1 #	Whistle	1 *	Whistle	1
001	JUNO Brass	2	Poly Brass	2	----		001	Whistle 2	2	----		----	
002	StackBrass	2	----		----		080	000 Ocarina	1 #	Ocarina	1 *	Ocarina	1
003	SH-5 Brass	2	----		----		Synth lead						
004	MKS Brass	2	----		----		081	000 Square Wave	2	Square Wave	2 *	Square Wave	2
008	Pro Brass	2	Syn.Brass 3	2 *	Syn.Brass 3	2	001	MG Square	1	Square	1 *	Square	1
009	P5 Brass	2	Quack Brass	2	----		002	Hollow Mini	1 #	Hollow Mini	1	----	
016	Oct SynBrass	2	OctaveBrass	2	Analog Brs1	2	003	Mellow FM	2 #	Mellow FM	2	----	
017	Hybrid Brass	2	----		----								

PC	CC00	Native Map	Voices	SC88 Map	Voices	SC55 Map	Voices	PC	CC00	Native Map	Voices	SC88 Map	Voices	SC55 Map	Voices
	004	CC Solo	2 #	CC Solo	2	----		085 000	Charang	2 #	Charang	2 *	Charang	2	
	005	Shmoog	2 #	Shmoog	2	----		008	Dist.Lead	2 #	Dist.Lead	2	----		
	006	LM Square	2 #	LM Square	2	----		009	Acid Guitar1	2	----	----			
	008	2600 Sine	1	Sine Wave	1 *	Sine Wave	1	010	Acid Guitar2	2	----	----			
	009	Sine Lead	1	----	----	----		016	P5 Sync Lead	1	----	----			
	010	KG Lead	1	----	----	----		017	Fat Sync Lead	2	----	----			
	016	P5 Square	1	----	----	----		018	Rock Lead	2	----	----			
	017	OB Square	1	----	----	----		019	5th DecaSync	2	----	----			
	018	JP-8 Square	1	----	----	----		020	Dirty Sync	1	----	----			
	024	Pulse Lead	2	----	----	----		024	JUNO Sub Osc	1	----	----			
	025	JP8 PulseLd1	2	----	----	----		086 000	Solo Vox	2 #	Solo Vox	2 *	Solo Vox	2	
	026	JP8 PulseLd2	1	----	----	----		008	Vox Lead	2	----	----			
	027	MG Reso. Pls	1	----	----	----		009	LFO Vox	2	----	----			
082 000	Saw Wave	2	Saw Wave	2 *	Saw Wave	2		087 000	5th Saw Wave	2 #	5th Saw	2 *	5th Saw	2	
	001	OB2 Saw	1	Saw	1 *	Saw	1	001	Big Fives	2 #	Big Fives	2	----		
	002	Pulse Saw	2 #	Pulse Saw	2	----		002	5th Lead	2	----	----			
	003	Feline GR	2 #	Feline GR	2	----		003	5th Ana.Clav	2	----	----			
	004	Big Lead	2 #	Big Lead	2	----		008	4th Lead	2	----	----			
	005	Velo Lead	2 #	Velo Lead	2	----		088 000	Bass & Lead	2 #	Bass & Lead	2 *	Bass & Lead	2	
	006	GR-300	2 #	GR-300	2	----		001	Big & Raw	2 #	Big & Raw	2	----		
	007	LA Saw	1 #	LA Saw	1	----		002	Fat & Perky	2 #	Fat & Perky	2	----		
	008	Doctor Solo	2 #	Doctor Solo	2 *	Doctor Solo	2	003	JUNO Rave	1	----	----			
	009	Fat Saw Lead	2	----	----	----		004	JP8 BsLead 1	1	----	----			
	011	D-50 Fat Saw	2	----	----	----		005	JP8 BsLead 2	2	----	----			
	016	Waspy Synth	2 #	Waspy Synth	2	----		006	SH-5 Bs.Lead	2	----	----			
	017	PM Lead	1	----	----	----		Synth pad, etc							
	018	CS Saw Lead	1	----	----	----		089 000	Fantasia	2 #	Fantasia	2 *	Fantasia	2	
	024	MG Saw 1	1	----	----	----		001	Fantasia 2	2 #	Fantasia 2	2	----		
	025	MG Saw 2	1	----	----	----		002	New Age Pad	2	----	----			
	026	OB Saw 1	1	----	----	----		003	Bell Heaven	2	----	----			
	027	OB Saw 2	1	----	----	----		090 000	Warm Pad	1 #	Warm Pad	1 *	Warm Pad	1	
	028	D-50 Saw	1	----	----	----		001	Thick Matrix	2	Thick Pad	2	----		
	029	SH-101 Saw	1	----	----	----		002	Horn Pad	2 #	Horn Pad	2	----		
	030	CS Saw	1	----	----	----		003	Rotary Strng	2 #	RotaryStrng	2	----		
	031	MG Saw Lead	1	----	----	----		004	OB Soft Pad	2	Soft Pad	2	----		
	032	OB Saw Lead	1	----	----	----		008	Octave Pad	2	----	----			
	033	P5 Saw Lead	2	----	----	----		009	Stack Pad	2	----	----			
	034	MG unison	2	----	----	----		091 000	Polysynth	2 #	Polysynth	2 *	Polysynth	2	
	035	Oct Saw Lead	2	----	----	----		001	80's PolySyn	2 #	80'sPolySyn	2	----		
	040	SequenceSaw1	2	----	----	----		002	Polysynth 2	2	----	----			
	041	SequenceSaw2	1	----	----	----		003	Poly King	2	----	----			
	042	Reso Saw	1	----	----	----		008	Power Stack	2	----	----			
	043	Cheese Saw 1	1	----	----	----		009	Octave Stack	2	----	----			
	044	Cheese Saw 2	2	----	----	----		010	Reso Stack	1	----	----			
	045	Rhythmic Saw	2	----	----	----		011	Techno Stack	2	----	----			
083 000	Syn.Calliope	2 #	SynCalliope	2 *	SynCalliope	2		092 000	Space Voice	1 #	Space Voice	1 *	Space Voice	1	
	001	Vent Synth	2 #	Vent Synth	2	----		001	Heaven II	2 #	Heaven II	2	----		
	002	Pure PanLead	2 #	PurePanLead	2	----		002	SC Heaven	2	----	----			
084 000	Chiffer Lead	2 #	ChifferLead	2 *	ChifferLead	2		008	Cosmic Voice	2	----	----			
	001	TB Lead	2	----	----	----		009	Auh Vox	1	----	----			
	008	Mad Lead	2	----	----	----		010	AuhAuh	2	----	----			

PC : program number(Instrument number)
 CC00 : value of controller number 0 (Bank number, Variation number)
 : : legato-enabled sounds
 Voices : number of voices used by the Instrument
 Remark # : same sounds as SC-88 map
 Remark * : same sound as SC-55 map
 Remark + : a percussive sound which cannot be played melodically. Use near C4 (note number 60).

PC	CC00 Native Map	Voices	SC88 Map	Voices	SC55 Map	Voices
	011 Vocorderman	2	----	----		
093 000	Bowed Glass	2 #	Bowed Glass	2 *	Bowed Glass	2
	001 SoftBellPad	2	----	----		
	002 JP8 Sqr Pad	2	----	----		
	003 7thBelPad	2	----	----		
094 000	Metal Pad	2 #	Metal Pad	2 *	Metal Pad	2
	001 Tine Pad	2 #	Tine Pad	2	----	
	002 Panner Pad	2 #	Panner Pad	2	----	
095 000	Halo Pad	2 #	Halo Pad	2 *	Halo Pad	2
	001 Vox Pad	2	----	----		
	002 Vox Sweep	2	----	----		
	008 Horror Pad	2	----	----		
096 000	Sweep Pad	1 #	Sweep Pad	1 *	Sweep Pad	1
	001 Polar Pad	1 #	Polar Pad	1	----	
	008 Converge	1 #	Converge	1	----	
	009 Shwimmer	2 #	Shwimmer	2	----	
	010 Celestial Pd	2 #	CelestialPd	2	----	
	011 Bag Sweep	2	----	----		
Synth SFX						
097 000	Ice Rain	2 #	Ice Rain	2 *	Ice Rain	2
	001 Harmo Rain	2 #	Harmo Rain	2	----	
	002 African wood	2 #	AfricanWood	2	----	
	003 Anklung Pad	2	----	----		
	004 Rattle Pad	2	----	----		
	008 Clavi Pad	2 #	Clavi Pad	2	----	
098 000	Soundtrack	2 #	Soundtrack	2 *	Soundtrack	2
	001 Ancestral	2 #	Ancestral	2	----	
	002 Prologue	2 #	Prologue	2	----	
	003 Prologue 2	2	----	----		
	004 Hols Strings	2	----	----		
	008 Rave	2 #	Rave	2	----	
099 000	Crystal	2 #	Crystal	2 *	Crystal	2
	001 Syn Mallet	1 #	Syn Mallet	1 *	Syn Mallet	1
	002 Soft Crystal	2 #	SoftCrystal	2	----	
	003 Round Glock	2 #	Round Glock	2	----	
	004 Loud Glock	2 #	Loud Glock	2	----	
	005 GlockenChime	2 #	GlocknChime	2	----	
	006 Clear Bells	2 #	Clear Bells	2	----	
	007 ChristmasBel	2 #	X'mas Bell	2	----	
	008 Vibra Bells	2 #	Vibra Bells	2	----	
	009 Digi Bells	2 #	Digi Bells	2	----	
	010 Music Bell	2	----	----		
	011 Analog Bell	1	----	----		
	016 Choral Bells	2 #	ChoralBells	2	----	
	017 Air Bells	2 #	Air Bells	2	----	
	018 Bell Harp	2 #	Bell Harp	2	----	
	019 Gamelimba	2 #	Gamelimba	2	----	
	020 JUNO Bell	2	----	----		
100 000	Atmosphere	2 #	Atmosphere	2 *	Atmosphere	2
	001 Warm Atmos	2 #	Warm Atmos	2	----	
	002 Nylon Harp	2 #	Nylon Harp	2	----	
	003 Harpvox	2 #	Harpvox	2	----	
	004 HollowReleas	2 #	HollowRels.	2	----	
	005 Nylon+Rhodes	2 #	NylonRhodes	2	----	
	006 Ambient Pad	2 #	Ambient Pad	2	----	
	007 Invisible	2	----	----		
	008 Pulsey Key	2	----	----		
	009 Noise Piano	2	----	----		

PC	CC00 Native Map	Voices	SC88 Map	Voices	SC55 Map	Voices
101 000	Brightness	2 #	Brightness	2 *	Brightness	2
	001 Shining Star	2	----	----		
	002 OB Stab	1	----	----		
	008 Org Bell	2	----	----		
102 000	Goblin	2 #	Goblin	2 *	Goblin	2
	001 Goblinson	2 #	Goblinson	2	----	
	002 50's Sci-Fi	2 #	50's Sci-Fi	2	----	
	003 Abduction	2	----	----		
	004 Auhbient	2	----	----		
	005 LFO Pad	2	----	----		
	006 Random Str	2	----	----		
	007 Random Pad	2	----	----		
	008 LowBirds Pad	2	----	----		
	009 Falling Down	2	----	----		
	010 LFO RAVE	2	----	----		
	011 LFO Horror	2	----	----		
	012 LFO Techno	2	----	----		
	013 Alternative	2	----	----		
	014 UFO FX	2	----	----		
	015 Gargle Man	1	----	----		
	016 Sweep FX	1	----	----		
103 000	Echo Drops	1 #	Echo Drops	1 *	Echo Drops	1
	001 Echo Bell	2 #	Echo Bell	2 *	Echo Bell	2
	002 Echo Pan	2 #	Echo Pan	2 *	Echo Pan	2
	003 Echo Pan 2	2 #	Echo Pan 2	2	----	
	004 Big Panner	2 #	Big Panner	2	----	
	005 Reso Panner	2 #	Reso Panner	2	----	
	006 Water Piano	2 #	Water Piano	2	----	
	008 Pan Sequence	2	----	----		
	009 Aqua	2	----	----		
104 000	Star Theme	2 #	Star Theme	2 *	Star Theme	2
	001 Star Theme 2	2 #	StarTheme 2	2	----	
	008 Dream Pad	2	----	----		
	009 Silky Pad	2	----	----		
	016 New Century	1	----	----		
	017 7th Atmos.	2	----	----		
	018 Galaxy Way	2	----	----		
Ethnic, etc						
105 000	Sitar	1 #	Sitar	1 *	Sitar	1
	001 Sitar 2	2 #	Sitar 2	2 *	Sitar 2	2
	002 Detune Sitar	2 #	DetuneSitar	2	----	
	003 Sitar 3	2	----	----		
	008 Tambra	1 #	Tambra	1	----	
	016 Tamboura	2 #	Tamboura	2	----	
106 000	Banjo	1 #	Banjo	1	Banjo	1
	001 Muted Banjo	1 #	Muted Banjo	1	----	
	008 Rabab	2 #	Rabab	2	----	
	009 San Xian	2	----	----		
	016 Gopichant	2 #	Gopichant	2	----	
	024 Oud	2 #	Oud	2	----	
	028 Oud+Strings	2	----	----		
	032 Pi Pa	1	----	----		
107 000	Shamisen	1 #	Shamisen	1 *	Shamisen	1
	001 Tsugaru	2 #	Tsugaru	2	----	
	008 Syn Shamisen	2	----	----		
108 000	Koto	2	Koto	1 *	Koto	1
	001 Gu Zheng	2	----	----		
	008 Taisho Koto	1 #	Taisho Koto	1	Taisho Koto	2

PC	CC00	Native Map	Voices	SC88 Map	Voices	SC55 Map	Voices
	016	Kanoon	2 #	Kanoon	2	----	
	019	Kanoon+Choir	2	----	----		
	024	Oct Harp	1	----	----		
109 000	Kalimba	1	Kalimba	1	Kalimba	1	
	008	Sanza	2	----	----		
110 000	Bagpipe	1 #	Bagpipe	1	Bagpipe	1	
	008	Didgeridoo	1 +	----	----		
111 000	Fiddle	1 #	Fiddle	1 *	Fiddle	1	
	008	Er Hu	1	----	----		
	009	Gao Hu	1	----	----		
112 000	Shanai	1 #	Shanai	1 *	Shanai	1	
	001	Shanai 2	1 #	Shanai 2	1	----	
	008	Pungi	1 #	Pungi	1	----	
	016	Hichiriki	2 #	Hichiriki	2	----	
	024	Mizmar	1	----	----		
	032	Suona 1	1	----	----		
	033	Suona 2	1	----	----		

Percussive

113 000	Tinkle Bell	1 #	Tinkle Bell	1 *	Tinkle Bell	1	
	008	Bonang	1 #	Bonang	1	----	
	009	Gender	1 #	Gender	1	----	
	010	Gamelan Gong	1 #	GamelanGong	1	----	
	011	St.Gamelan	2 #	St.Gamelan	2	----	
	012	Jang-Gu	2	----	----		
	016	RAMA Cymbal	1 #	RAMA Cymbal	1	----	
114 000	Agogo	1 #	Agogo	1	Agogo	1	
	008	Atarigane	1 #	Atarigane	1	----	
	016	Tambourine	1 +	----	----		
115 000	Steel Drums	1 #	Steel Drums	1 *	Steel Drums	1	
	001	Island Mlt	2	----	----		
116 000	Woodblock	1 # +	Woodblock	1 * +	Woodblock	1 +	
	008	Castanets	1 # +	Castanets	1 * +	Castanets	1 +
	016	Angklung	1	----	----		
	017	Angkl Rhythm	2	----	----		
	024	Finger Snaps	1 +	----	----		
	032	909 HandClap	1 +	----	----		
117 000	Taiko	1 # +	Taiko	1 * +	Taiko	1 +	
	001	Small Taiko	1 +	----	----		
	008	Concert BD	1 # +	Concert BD	1 * +	Concert BD	1 +
	016	Jungle BD	1 +	----	----		
	017	Techno BD	1 +	----	----		
	018	Bounce	1 +	----	----		
118 000	Melo. Tom 1	1 # +	Melo. Tom 1	1 * +	Melo. Tom 1	1 +	
	001	Real Tom	2 # +	Real Tom	2 +	----	
	008	Melo. Tom 2	1 # +	Melo. Tom 2	1 * +	Melo. Tom 2	1 +
	009	Rock Tom	2 # +	Rock Tom	2 +	----	
	016	Rash SD	1 +	----	----		
	017	House SD	1 +	----	----		
	018	Jungle SD	1 +	----	----		
	019	909 SD	1 +	----	----		

PC : program number(Instrument number)
CC00 : value of controller number 0 (Bank number, Variation number)
: : legato-enabled sounds
Voices : number of voices used by the Instrument
Remark # : same sounds as SC-88 map
Remark * : same sound as SC-55 map
Remark + : a percussive sound which cannot be played melodically. Use near C4 (note number 60).

PC	CC00	Native Map	Voices	SC88 Map	Voices	SC55 Map	Voices
119 000	Synth Drum	1 # +	Synth Drum	1 * +	Synth Drum	1 +	
	008	808 Tom	2 # +	808 Tom	2 +	808 Tom	1 +
	009	Elec Perc	1 # +	Elec Perc	1 * +	Elec Perc	1 +
	010	Sine Perc.	1	----	----		
	011	606 Tom	1 +	----	----		
	012	909 Tom	1 +	----	----		
120 000	Reverse Cym.	1 # +	Reverse Cym	1 * +	Reverse Cym	1 +	
	001	Reverse Cym2	1 # +	ReverseCym2	1 +	----	
	002	Reverse Cym3	1 +	----	----		
	008	Rev.Snare 1	1 # +	Rev.Snare 1	1 +	----	
	009	Rev.Snare 2	1 # +	Rev.Snare 2	1 +	----	
	016	Rev.Kick 1	1 # +	Rev.Kick 1	1 +	----	
	017	Rev.ConBD	1 # +	Rev.ConBD	1 +	----	
	024	Rev.Tom 1	1 # +	Rev.Tom 1	1 +	----	
	025	Rev.Tom 2	1 # +	Rev.Tom 2	1 +	----	

SFX

121 000	Gt.FretNoise	1 #	Gt.FretNoiz	1 *	Gt.FretNoiz	1	
	001	Gt.Cut Noise	1 # +	Gt.CutNoise	1 * +	Gt.CutNoise	1 +
	002	String Slap	1 # +	String Slap	1 * +	String Slap	1 +
	003	Gt.CutNoise2	1 # +	Gt.CutNz. 2	1 +	----	
	004	Dist.CutNoiz	1 # +	Dist.CutNz.	1 +	----	
	005	Bass Slide	1 # +	Bass Slide	1 +	----	
	006	Pick Scrape	1 # +	Pick Scrape	1 +	----	
	008	Gt. FX Menu	1	----	----		
	009	Bartok Pizz.	1	----	----		
	010	Guitar Slap	1 +	----	----		
	011	Chord Stroke	1	----	----		
	012	Biwa Stroke	1 +	----	----		
	013	Biwa Tremolo	1 +	----	----		
122 000	Breath Noise	1 #	BreathNoise	1 *	BreathNoise	1	
	001	Fl.Key Click	1 # +	Fl.KeyClick	1 * +	Fl.KeyClick	1 +
123 000	Seashore	1 # +	Seashore	1 * +	Seashore	1 +	
	001	Rain	1 # +	Rain	1 * +	Rain	1 +
	002	Thunder	1 # +	Thunder	1 * +	Thunder	1 +
	003	Wind	1 # +	Wind	1 * +	Wind	1 +
	004	Stream	2 # +	Stream	2 * +	Stream	2 +
	005	Bubble	2 # +	Bubble	2 * +	Bubble	2 +
	006	Wind 2	1 +	----	----		
	016	Pink Noise	1	----	----		
	017	White Noise	1	----	----		
124 000	Bird	2 # +	Bird	2 * +	Bird	2 +	
	001	Dog	1 # +	Dog	1 * +	Dog	1 +
	002	Horse-Gallop	1 # +	HorseGallop	1 * +	HorseGallop	1 +
	003	Bird 2	1 # +	Bird 2	1 * +	Bird 2	1 +
	004	Kitty	1 # +	Kitty	1 +	----	
	005	Growl	1 # +	Growl	1 +	----	
125 000	Telephone 1	1 # +	Telephone 1	1 * +	Telephone 1	1 +	
	001	Telephone 2	1 # +	Telephone 2	1 * +	Telephone 2	1 +
	002	DoorCreaking	1 # +	Creaking	1 * +	Creaking	1 +
	003	Door	1 # +	Door	1 * +	Door	1 +
	004	Scratch	1 # +	Scratch	1 * +	Scratch	1 +

PC	CC00 Native Map	Voices SC88 Map	Voices SC55 Map	Voices
005	Wind Chimes	2 # + Wind Chimes	2 * + Wind Chimes	2 +
007	Scratch 2	1 # + Scratch 2	1 + ----	
008	ScratchKey	2 + ----	----	
009	TapeRewind	1 + ----	----	
010	Phono Noise	1 + ----	----	
011	MC-500 Beep	1 ----	----	
126 000	Helicopter	1 # + Helicopter	1 * + Helicopter	1 +
001	Car-Engine	1 # + Car-Engine	1 * + Car-Engine	1 +
002	Car-Stop	1 # + Car-Stop	1 * + Car-Stop	1 +
003	Car-Pass	1 # + Car-Pass	1 * + Car-Pass	1 +
004	Car-Crash	2 # + Car-Crash	2 * + Car-Crash	2 +
005	Siren	1 # + Siren	1 * + Siren	1 +
006	Train	1 # + Train	1 * + Train	1 +
007	Jetplane	2 # + Jetplane	2 * + Jetplane	2 +
008	Starship	2 # + Starship	2 * + Starship	2 +
009	Burst Noise	2 # + Burst Noise	2 * + Burst Noise	2 +
010	Calculating	2 + ----	----	
011	Perc. Bang	2 + ----	----	
127 000	Applause	2 # + Applause	2 * + Applause	2 +
001	Laughing	1 # + Laughing	1 * + Laughing	1 +
002	Screaming	1 # + Screaming	1 * + Screaming	1 +
003	Punch	1 # + Punch	1 * + Punch	1 +
004	Heart Beat	1 # Heart Beat	1 * Heart Beat	1
005	Footsteps	1 # + Footsteps	1 * + Footsteps	1 +
006	Applause 2	2 # + Applause 2	2 + ----	
007	Small Club	2 + ----	----	
008	ApplauseWave	2 + ----	----	
016	Voice One	1 + ----	----	
017	Voice Two	1 + ----	----	
018	Voice Three	1 + ----	----	
019	Voice Tah	1 + ----	----	
020	Voice Whey	1 + ----	----	
128 000	Gun Shot	1 # + Gun Shot	1 * + Gun Shot	1 +
001	Machine Gun	1 # + Machine Gun	1 * + Machine Gun	1 +
002	Lasergun	1 # + Lasergun	1 * + Lasergun	1 +
003	Explosion	2 # + Explosion	2 * + Explosion	2 +
004	Eruption	1 + ----	----	
005	Big Shot	2 + ----	----	

SC-55 MAP (CM-64 Sound Map)

CM-64				CM-64				CM-64			
PC	CC00	Instrument	No. of voices	PC	CC00	Instrument	No. of voices	PC	CC00	Instrument	No. of voices
001	126	Piano 2	1	001	127	Acou Piano1	1	065	127	Acou Bass 1	1
002	126	Piano 2	1	002	127	Acou Piano2	1	066	127	Acou Bass 2	1
003	126	Piano 2	1	003	127	Acou Piano3	1	067	127	Elec Bass 1	1
004	126	Honky-tonk	2	004	127	Elec Piano1	1	068	127	Elec Bass 2	1
005	126	Piano 1	1	005	127	Elec Piano2	1	069	127	Slap Bass 1	1
006	126	Piano 2	1	006	127	Elec Piano3	1	070	127	Slap Bass 2	1
007	126	Piano 2	1	007	127	Elec Piano4	1	071	127	Fretless 1	1
008	126	E.Piano 1	1	008	127	Honkytonk	2	072	127	Fretless 2	1
009	126	Detuned EP1	2	009	127	Elec Org 1	1	073	127	Flute 1	1
010	126	E.Piano 2	1	010	127	Elec Org 2	2	074	127	Flute 2	1
011	126	Steel Gt.	1	011	127	Elec Org 3	1	075	127	Piccolo 1	1
012	126	Steel Gt.	1	012	127	Elec Org 4	1	076	127	Piccolo 2	2
013	126	12-str.Gt	2	013	127	Pipe Org 1	2	077	127	Recorder	1
014	126	Funk Gt.	1	014	127	Pipe Org 2	2	078	127	Pan Pipes	1
015	126	Muted Gt.	1	015	127	Pipe Org 3	2	079	127	Sax 1	1
016	126	Slap Bass 1	1	016	127	Accordion	2	080	127	Sax 2	1
017	126	Slap Bass 1	1	017	127	Harpsi 1	1	081	127	Sax 3	1
018	126	Slap Bass 1	1	018	127	Harpsi 2	2	082	127	Sax 4	1
019	126	Slap Bass 1	1	019	127	Harpsi 3	1	083	127	Clarinet 1	1
020	126	Slap Bass 2	1	020	127	Clavi 1	1	084	127	Clarinet 2	1
021	126	Slap Bass 2	1	021	127	Clavi 2	1	085	127	Oboe	1
022	126	Slap Bass 2	1	022	127	Clavi 3	1	086	127	Engl Horn	1
023	126	Slap Bass 2	1	023	127	Celesta 1	1	087	127	Bassoon	1
024	126	Fingered Bs	1	024	127	Celesta 2	1	088	127	Harmonica	1
025	126	Fingered Bs	1	025	127	Syn Brass 1	2	089	127	Trumpet 1	1
026	126	Picked Bass	1	026	127	Syn Brass 2	2	090	127	Trumpet 2	1
027	126	Picked Bass	1	027	127	Syn Brass 3	2	091	127	Trombone 1	2
028	126	Fretless Bs	1	028	127	Syn Brass 4	2	092	127	Trombone 2	2
029	126	Acoustic Bs	1	029	127	Syn Bass 1	1	093	127	Fr Horn 1	2
030	126	Choir Aahs	1	030	127	Syn Bass 2	2	094	127	Fr Horn 2	2
031	126	Choir Aahs	1	031	127	Syn Bass 3	2	095	127	Tuba	1
032	126	Choir Aahs	1	032	127	Syn Bass 4	1	096	127	Brs Sect 1	1
033	126	Choir Aahs	1	033	127	Fantasy	2	097	127	Brs Sect 2	2
034	126	SlowStrings	1	034	127	Harmo Pan	2	098	127	Vibe 1	1
035	126	Strings	1	035	127	Chorale	1	099	127	Vibe 2	1
036	126	SynStrings3	2	036	127	Glasses	2	100	127	Syn Mallet	1
037	126	SynStrings3	2	037	127	Soundtrack	2	101	127	Windbell	2
038	126	Organ 1	1	038	127	Atmosphere	2	102	127	Glock	1
039	126	Organ 1	1	039	127	Warm Bell	2	103	127	Tube Bell	1
040	126	Organ 1	1	040	127	Funny Vox	1	104	127	Xylophone	1
041	126	Organ 2	1	041	127	Echo Bell	2	105	127	Marimba	1
042	126	Organ 1	1	042	127	Ice Rain	2	106	127	Koto	1
043	126	Organ 1	1	043	127	Oboe 2001	2	107	127	Sho	2
044	126	Organ 2	1	044	127	Echo Pan	2	108	127	Shakuhachi	2
045	126	Organ 2	1	045	127	Doctor Solo	2	109	127	Whistle 1	2
046	126	Organ 2	1	046	127	School Daze	1	110	127	Whistle 2	1
047	126	Trumpet	1	047	127	Bellsinger	1	111	127	Bottleblow	2
048	126	Trumpet	1	048	127	Square Wave	2	112	127	Breathpipe	1
049	126	Trombone	1	049	127	Str Sect 1	1	113	127	Timpani	1
050	126	Trombone	1	050	127	Str Sect 2	1	114	127	Melodic Tom	1
051	126	Trombone	1	051	127	Str Sect 3	1	115	127	Deep Snare	1 +
052	126	Trombone	1	052	127	Pizzicato	1	116	127	Elec Perc 1	1 +
053	126	Trombone	1	053	127	Violin 1	1	117	127	Elec Perc 2	1 +
054	126	Trombone	1	054	127	Violin 2	1	118	127	Taiko	1 +
055	126	Alto Sax	1	055	127	Cello 1	1	119	127	Taiko Rim	1
056	126	Tenor Sax	1	056	127	Cello 2	1	120	127	Cymbal	1
057	126	BaritoneSax	1	057	127	Contrabass	1	121	127	Castanets	1 +
058	126	Alto Sax	1	058	127	Harp 1	1	122	127	Triangle	1 +
059	126	Brass 1	1	059	127	Harp 2	1	123	127	Orche Hit	1
060	126	Brass 1	1	060	127	Guitar 1	1	124	127	Telephone	1 +
061	126	Brass 2	2	061	127	Guitar 2	1	125	127	Bird Tweet	1 +
062	126	Brass 2	2	062	127	Elec Gtr 1	1	126	127	OneNote Jam	1 +
063	126	Brass 1	1	063	127	Elec Gtr 2	1	127	127	Water Bell	2
064	126	Orchest.Hit	2	064	127	Sitar	2	128	127	Jungle Tune	2

■ Drum set list

The drum sets of this unit are organized as follows.

The Native map has 25 types, the SC-88 map has 14 types, and the SC-55 map has 10 types.

PC	Native Map		SC-88Map	SC-55Map
001	STANDARD 1		STANDARD 1	STANDARD
002	STANDARD 2	#	STANDARD 2	---
003	STANDARD 3	*	---	---
009	ROOM	#	ROOM	ROOM
010	HIP HOP		---	---
011	JUNGLE		---	---
012	TECHNO		---	---
017	POWER		POWER	POWER
025	ELECTRONIC	#	ELECTRONIC	ELECTRONIC
026	TR-808		TR-808/909	TR-808
027	DANCE		DANCE	---
028	CR-78		---	---
029	TR-606		---	---
030	TR-707		---	---
031	TR-909		---	---
033	JAZZ		JAZZ	JAZZ
041	BRUSH		BRUSH	BRUSH
049	ORCHESTRA	#	ORCHESTRA	ORCHESTRA
050	ETHNIC	#	ETHNIC	---
051	KICK & SNARE	#	KICK & SNARE	---
053	ASIA		---	---
054	CYMBAL&CLAPS		---	---
057	SFX		SFX	SFX
058	RHYTHM FX	#	RHYTHM FX	---
059	RHYTHM FX 2		---	---
128	---		---	CM-64/32L

: Same as the SC-88 map drum sets

* : Sounds in the STANDARD 3 drum set that have "RND" appended to their name (such as Kick, Snare, and Hi-Hat) in the list on the next page are sounds which will change randomly with each note played (these changes affect the timbre and timing). The purpose of this is to create a more natural sounding performance--even if all note messages for percussive instruments are sent with absolute precision, subtle fluctuations will be applied so the performance sounds less mechanical.

Note, however, that you may not always be able to obtain the desired effect, depending on the circumstances.

Native Drum set (1)

#: Same Drum Set as SC-88 map

	PC1	PC2	PC3	PC9	PC10	
	STANDARD 1	STANDARD 2 #	STANDARD 3	ROOM #	Hip-Hop	
	22	MC-500 Beep 1	←	←	←	
	23	MC-500 Beep 2	←	←	←	
C1	24	Concert SD	←	←	←	
	25	Snare Roll	←	←	←	
	26	Finger Snap 2	Finger Snap	Finger Snap	←	
	27	High Q	←	←	←	
	28	Slap	←	←	←	
	29	Scratch Push [EXC7]	←	←	Scratch Push 2 [EXC7]	
	30	Scratch Pull [EXC7]	←	←	Scratch Pull 2 [EXC7]	
	31	Sticks	←	←	←	
	32	Square Click	←	←	←	
	33	Metronome Click	←	←	←	
	34	Metronome Bell	←	←	←	
	35	Standard 1 Kick 2	Standard 2 Kick 2	Standard 3 Kick 2	Room Kick 2	Hip-Hop Kick 2
C2	36	Standard 1 Kick 1	Standard 2 Kick 1	[RND] Kick	Room Kick 1	Hip-Hop Kick 1
	37	Side Stick	←	←	←	TR-808 Rim Shot
	38	Standard 1 Snare 1	Standard 2 Snare 1	[RND] Snare	Room Snare 1	Rap Snare
	39	TR-909 Hand Clap	Hand Clap	[RND] Hand Clap *	Hand Clap	←
	40	Standard 1 Snare 2	Standard 2 Snare 2	Standard 3 Snare 2	Room Snare 2	Hip-Hop Snare 2
	41	Low Tom 2 *	←	←	Room Low Tom 2 *	TR-909 Low Tom 2
	42	Closed Hi-Hat [EXC1]	Closed Hi-Hat [EXC1]	[RND] Closed Hi-Hat [EXC1]	Closed Hi-Hat 3 [EXC1]	Room Closed Hi-Hat [EXC1]
	43	Low Tom 1 *	←	←	Room Low Tom 1 *	TR-909 Low Tom 1
	44	Pedal Hi-Hat [EXC1]	Pedal Hi-Hat [EXC1]	[RND] Pedal Hi-Hat [EXC1]	Pedal Hi-Hat [EXC1]	Pedal Hi-Hat [EXC1]
	45	Mid Tom 2 *	←	←	Room Mid Tom 2 *	TR-909 Mid Tom 2
	46	Open Hi-Hat [EXC1]	Open Hi-Hat [EXC1]	[RND] Open Hi-Hat [EXC1]	Open Hi-Hat 3 [EXC1]	Room Open Hi-Hat [EXC1]
	47	Mid Tom 1 *	←	←	Room Mid Tom 1 *	TR-909 Mid Tom 1
C3	48	High Tom 2 *	←	←	Room High Tom 2 *	TR-909 High Tom 2
	49	Crash Cymbal1	←	[RND] Crash Cymbal	←	TR-909 Crash Cymbal
	50	High Tom 1 *	←	←	Room High Tom 1 *	TR-909 High Tom 1
	51	Ride Cymbal 1	←	[RND] Ride Cymbal 1 *	←	←
	52	Chinese Cymbal	←	←	←	Reverse Cymbal
	53	Ride Bell	←	[RND] Ride Bell 1	←	←
	54	Tambourine	←	←	←	Shake Tambourine
	55	Splash Cymbal	←	←	←	←
	56	Cowbell	←	←	←	TR-808 Cowbell
	57	Crash Cymbal 2	←	←	←	←
	58	Vibra-slap	←	←	←	←
	59	Ride Cymbal 2	←	[RND] Ride Cymbal 2 *	←	←
C4	60	High Bongo	←	←	←	←
	61	Low Bongo	←	←	←	←
	62	Mute High Conga	←	←	←	←
	63	Open High Conga	←	←	←	←
	64	Low Conga	←	←	←	←
	65	High Timbale	←	←	←	←
	66	Low Timbale	←	←	←	←
	67	High Agogo	←	←	←	←
	68	Low Agogo	←	←	←	←
	69	Cabasa	←	←	←	←
	70	Maracas	←	←	←	TR-808 Maracas
	71	Short High Whistle [EXC2]	←	←	←	←
C5	72	Long Low Whistle [EXC2]	←	←	←	←
	73	Short Guiro [EXC3]	←	←	←	←
	74	Long Guiro [EXC3]	←	←	←	CR-78 Guiro [EXC3]
	75	Claves	←	←	←	TR-808 Claves
	76	High Wood Block	←	←	←	←
	77	Low Wood Block	←	←	←	←
	78	Mute Cuica [EXC4]	←	←	←	High Hoo [EXC4]
	79	Open Cuica [EXC4]	←	←	←	Low Hoo [EXC4]
	80	Mute Triangle [EXC5]	←	←	←	Mute Triangle
	81	Open Triangle [EXC5]	←	←	←	Open Triangle
	82	Shaker	←	←	←	TR-626 Shaker
	83	Jingle Bell	←	←	←	←
C6	84	Bell Tree	Bar Chimes	←	←	←
	85	Castanets	←	←	←	←
	86	Mute Surdo [EXC6]	←	←	←	←
	87	Open Surdo [EXC6]	←	←	←	←
	88	Applause 2 *	←	←	←	Small Club 1 *
	89	---	---	---	---	---
	90	---	---	---	---	---
	91	---	---	---	---	---
	92	---	---	---	---	---
	93	---	---	---	---	---
	94	---	---	---	---	---
	95	---	---	---	---	---
C7	96	---	---	---	---	---

Note Number

PC : Program Number (Drum Set Number) ← : Same as the percussion sound of *STANDARD1*(PC1). [88] : Same as the percussion sound of SC-88
 --- : No sound [EXC] : Percussion sound of the same number will not be heard at the same time. [55] : Same as the percussion sound of SC-55
 * : Tones which are created using two voices

Native Drum set (2)

#: Same Drum Set as SC-88 map

	PC 11 JUNGLE	PC 12 TECHNO	PC 17 POWER	PC 25 ELECTRONIC #	PC 26 TR-808
	22	←	←	←	←
	23	←	←	←	←
C1	24	←	←	←	←
	25	←	←	←	←
	26	←	←	Finger Snap 2	←
	27	←	←	←	←
	28	←	←	←	←
	29	Scratch Push 2	[EXC7] Scratch Push 2	[EXC7] Scratch Push 2	[EXC7] Scratch Push 2
	30	Scratch Pull 2	[EXC7] Scratch Pull 2	[EXC7] Scratch Pull 2	[EXC7] Scratch Pull 2
	31	←	←	←	←
	32	←	←	←	←
	33	←	←	←	←
	34	←	←	←	←
	35	Jungle Kick 2	Techno Kick 2	Power Kick 2	Electric Kick 2
C2	36	Jungle Kick 1	Techno Kick 1	Power Kick 1	Electric Kick 1 *
	37	←	TR-808 Rim Shot	←	TR-808 Rim Shot
	38	Jungle Snare 1	Techno Snare 1	Power Snare 1	Electric Snare 1
	39	Hand Clap 2	TR-707 Hand Clap	Hand Clap	Hand Clap
	40	Jungle Snare 2	Techno Snare 2	Power Snare 2	Electric Snare 2
	41	TR-909 Low Tom 2	TR-808 Low Tom 2 *	Power Low Tom 2 *	Electric Low Tom 2 *
	42	TR-606 Closed Hi-Hat [EXC1]	TR-707 Closed Hi-Hat [EXC1]	←	Closed Hi-Hat 2 [EXC1]
	43	TR-909 Low Tom 1	TR-808 Low Tom 1 *	Power Low Tom 1 *	Electric Low Tom 1 *
	44	Jungle Hi-Hat [EXC1]	CR-78 Closed Hi-Hat [EXC1]	←	Pedal Hi-Hat [EXC1]
	45	TR-909 Mid Tom 2	TR-808 Mid Tom 2 *	Power Mid Tom 2 *	Electric Mid Tom 2 *
	46	TR-606 Open Hi-Hat [EXC1]	TR-909 Open Hi-Hat [EXC1]	←	Open Hi-Hat 2 [EXC1]
	47	TR-909 Mid Tom 1	TR-808 Mid Tom 1 *	Power Mid Tom 1 *	Electric Mid Tom 1 *
C3	48	TR-909 High Tom 2	TR-808 High Tom 2 *	Power High Tom 2 *	Electric High Tom 2 *
	49	TR-808 Crash Cymbal	TR-909 Crash Cymbal	←	TR-808 Crash Cymbal
	50	TR-909 High Tom 1	TR-808 High Tom 1 *	Power High Tom 1 *	Electric High Tom 1 *
	51	←	←	←	TR-606 Ride Cymbal
	52	Reverse Cymbal	Reverse Cymbal	←	Reverse Cymbal
	53	←	←	←	←
	54	Shake Tambourine	Shake Tambourine	←	CR-78 Tambourine
	55	←	←	←	←
	56	TR-808 Cowbell	TR-808 Cowbell	←	TR-808 Cowbell
	57	←	TR-909 Crash Cymbal	←	TR-909 Crash Cymbal
	58	←	←	←	←
	59	←	←	←	Ride Cymbal 2
C4	60	←	CR-78 High Bongo	←	CR-78 High Bongo
	61	←	CR-78 Low Bongo	←	CR-78 Low Bongo
	62	←	TR-808 High Conga	←	TR-808 High Conga
	63	←	TR-808 Mute Conga	←	TR-808 Mute Conga
	64	←	TR-808 Low Conga	←	TR-808 Low Conga
	65	←	←	←	←
	66	←	←	←	←
	67	←	←	←	←
	68	←	←	←	←
	69	←	←	←	←
	70	TR-808 Maracas	TR-808 Maracas	←	TR-808 Maracas
	71	←	←	←	←
C5	72	←	←	←	←
	73	←	←	←	←
	74	CR-78 Guiro [EXC3]	CR-78 Guiro [EXC3]	←	CR-78 Guiro [EXC3]
	75	TR-808 Claves	TR-808 Claves	←	TR-808 Claves
	76	←	←	←	←
	77	←	←	←	←
	78	High Hoo [EXC4]	High Hoo [EXC4]	←	High Hoo [EXC4]
	79	Low Hoo [EXC4]	Low Hoo [EXC4]	←	Low Hoo [EXC4]
	80	Mute Triangle	Mute Triangle	←	Mute Triangle
	81	Open Triangle	Open Triangle	←	Open Triangle
	82	TR-626 Shaker	TR-626 Shaker	←	TR-626 Shaker
	83	←	←	←	←
C6	84	←	←	←	←
	85	←	←	←	←
	86	←	←	←	←
	87	←	←	←	←
	88	Small Club 1 *	←	←	Small Club 1 *
	89	---	---	---	---
	90	---	---	---	---
	91	---	---	---	---
	92	---	---	---	---
	93	---	---	---	---
	94	---	---	---	---
	95	---	---	---	---
C7	96	---	---	---	---

PC : Program Number (Drum Set Number) ← : Same as the percussion sound of "STANDARD1"(PC1). [88] : Same as the percussion sound of SC-88
 --- : No sound [EXC]: Percussion sound of the same number will not be heard at the same time. [55] : Same as the percussion sound of SC-55
 * : Tones which are created using two voices

Native Drum set (3)

#: Same Drum Set as SC-88 map

	PC 27 DANCE		PC 28 CR-78		PC 29 TR-606		PC 30 TR-707
C1	22	←	←	←	←	←	←
	23	←	←	←	←	←	←
	24	←	←	←	←	←	←
	25	←	←	←	←	←	←
	26	Finger Snap 2	←	←	←	←	←
	27	←	←	←	←	←	←
	28	←	←	←	←	←	←
	29	Scratch Push 2	[EXC7] Scratch Push 2	[EXC7] Scratch Push 2	[EXC7] Scratch Push 2	[EXC7] Scratch Push 2	[EXC7] Scratch Push 2
	30	Scratch Pull 2	[EXC7] Scratch Pull 2	[EXC7] Scratch Pull 2	[EXC7] Scratch Pull 2	[EXC7] Scratch Pull 2	[EXC7] Scratch Pull 2
	31	←	←	←	←	←	←
	32	←	←	←	←	←	←
	33	←	←	←	←	←	←
	34	←	←	←	←	←	←
	35	TR-909 Comp Kick	CR-78 Kick 2	CR-78 Kick 2	TR-707 Kick 2	TR-707 Kick 2	TR-707 Kick 2
C2	36	Electric Kick 2	CR-78 Kick 1	TR-606 Kick 1	TR-707 Kick 1	TR-707 Kick 1	TR-707 Kick 1
	37	←	CR-78 Rim Shot	CR-78 Rim Shot	TR-707 Rim Shot	TR-707 Rim Shot	TR-707 Rim Shot
	38	House Snare	CR-78 Snare 1	TR-606 Snare 1	TR-707 Snare 1	TR-707 Snare 1	TR-707 Snare 1
	39	←	TR-707 Hand Clap	TR-707 Hand Clap	TR-707 Hand Clap	TR-707 Hand Clap	TR-707 Hand Clap
	40	Dance Snare 2	CR-78 Snare 2	TR-606 Snare 2	TR-707 Snare 2	TR-707 Snare 2	TR-707 Snare 2
	41	Electric Low Tom 2	* CR-78 Low Tom 2	* TR-606 Low Tom 2	TR-707 Low Tom 2	TR-707 Low Tom 2	* TR-707 Low Tom 2
	42	CR-78 Closed Hi-Hat	[EXC1] CR-78 Closed Hi-Hat	[EXC1] TR-606 Closed Hi-Hat	[EXC1] TR-707 Closed Hi-Hat	[EXC1] TR-707 Closed Hi-Hat	[EXC1] TR-707 Closed Hi-Hat
	43	Electric Low Tom 1	* CR-78 Low Tom 1	* TR-606 Low Tom 1	TR-707 Low Tom 1	TR-707 Low Tom 1	* TR-707 Low Tom 1
	44	TR-808 Closed Hi-Hat 2	[EXC1] TR-606 Closed Hi-Hat	[EXC1] TR-606 Closed Hi-Hat	[EXC1] TR-707 Closed Hi-Hat	[EXC1] TR-707 Closed Hi-Hat	[EXC1] TR-707 Closed Hi-Hat
	45	Electric Mid Tom 2	* CR-78 Mid Tom 2	* TR-606 Mid Tom 2	TR-707 Mid Tom 2	TR-707 Mid Tom 2	* TR-707 Mid Tom 2
	46	CR-78 Open Hi-Hat	[EXC1] CR-78 Open Hi-Hat	[EXC1] TR-606 Open Hi-Hat	[EXC1] TR-707 Open Hi-Hat	[EXC1] TR-707 Open Hi-Hat	[EXC1] TR-707 Open Hi-Hat
	47	Electric Mid Tom 1	* CR-78 Mid Tom 1	* TR-606 Mid Tom 1	TR-707 Mid Tom 1	TR-707 Mid Tom 1	* TR-707 Mid Tom 1
C3	48	Electric High Tom 2	* CR-78 High Tom 2	* TR-606 High Tom 2	TR-707 High Tom 2	TR-707 High Tom 2	* TR-707 High Tom 2
	49	TR-808 Crash Cymbal	TR-808 Crash Cymbal	TR-808 Crash Cymbal	TR-909 Crash Cymbal	TR-909 Crash Cymbal	TR-909 Crash Cymbal
	50	Electric High Tom 1	* CR-78 High Tom 1	* TR-606 High Tom 1	TR-707 High Tom 1	TR-707 High Tom 1	* TR-707 High Tom 1
	51	TR-606 Ride Cymbal	TR-606 Ride Cymbal	TR-606 Ride Cymbal	TR-909 Ride Cymbal	TR-909 Ride Cymbal	* TR-909 Ride Cymbal
	52	Reverse Cymbal	←	←	←	←	←
	53	←	←	←	←	←	←
	54	Shake Tambourine	CR-78 Tambourine	CR-78 Tambourine	Tambourine 2	Tambourine 2	Tambourine 2
	55	←	←	←	←	←	←
	56	TR-808 Cowbell	CR-78 Cowbell	CR-78 Cowbell	TR-808 Cowbell	TR-808 Cowbell	TR-808 Cowbell
	57	←	TR-909 Crash Cymbal	TR-909 Crash Cymbal	←	←	←
	58	←	←	←	←	←	←
	59	←	Ride Cymbal Edge	Ride Cymbal Edge	Ride Cymbal Edge	Ride Cymbal Edge	Ride Cymbal Edge
C4	60	←	CR-78 High Bongo	CR-78 High Bongo	←	←	←
	61	←	CR-78 Low Bongo	CR-78 Low Bongo	←	←	←
	62	←	TR-808 High Conga	TR-808 High Conga	←	←	←
	63	←	TR-808 Mute Conga	TR-808 Mute Conga	←	←	←
	64	←	TR-808 Low Conga	TR-808 Low Conga	←	←	←
	65	←	←	←	←	←	←
	66	←	←	←	←	←	←
	67	←	←	←	←	←	←
	68	←	←	←	←	←	←
	69	←	←	←	←	←	←
	70	←	CR-78 Maracas	CR-78 Maracas	TR-808 Maracas	TR-808 Maracas	TR-808 Maracas
	71	←	←	←	←	←	←
C5	72	←	←	←	←	←	←
	73	←	←	←	←	←	←
	74	←	CR-78 Guiro	[EXC3] CR-78 Guiro	[EXC3] TR-707 Guiro	[EXC3] TR-707 Guiro	[EXC3] TR-707 Guiro
	75	←	CR-78 Claves	CR-78 Claves	←	←	←
	76	←	←	←	←	←	←
	77	←	←	←	←	←	←
	78	High Hoo	[EXC4] High Hoo	[EXC4] High Hoo	[EXC4] High Hoo	[EXC4] High Hoo	[EXC4] High Hoo
	79	Low Hoo	[EXC4] Low Hoo	[EXC4] Low Hoo	[EXC4] Low Hoo	[EXC4] Low Hoo	[EXC4] Low Hoo
	80	Mute Triangle	CR-78 Metallic Beat 1	[EXC5] CR-78 Metallic Beat 1	[EXC5] Mute Triangle	[EXC5] Mute Triangle	[EXC5] Mute Triangle
	81	Open Triangle	CR-78 Metallic Beat 2	[EXC5] CR-78 Metallic Beat 2	[EXC5] Open Triangle	[EXC5] Open Triangle	[EXC5] Open Triangle
	82	TR-626 Shaker	TR-626 Shaker	TR-626 Shaker	TR-626 Shaker	TR-626 Shaker	TR-626 Shaker
	83	←	←	←	←	←	←
C6	84	←	←	←	←	←	←
	85	←	←	←	←	←	←
	86	←	←	←	←	←	←
	87	←	←	←	←	←	←
	88	Small Club 1	* Small Club 1	* Small Club 1	* Small Club 1	* Small Club 1	* Small Club 1
	89	---	---	---	---	---	---
	90	---	---	---	---	---	---
	91	---	---	---	---	---	---
	92	---	---	---	---	---	---
	93	---	---	---	---	---	---
	94	---	---	---	---	---	---
	95	---	---	---	---	---	---
C7	96	---	---	---	---	---	---

PC : Program Number (Drum Set Number) ← : Same as the percussion sound of "STANDARD1"(PC1). [88] : Same as the percussion sound of SC-88
 --- : No sound [EXC] : Percussion sound of the same number will not be heard at the same time. [55] : Same as the percussion sound of SC-55
 * : Tones which are created using two voices

Note Number

Native Drum set (4)

#: Same Drum Set as SC-88 map

	PC 31 TR-909	PC 33 JAZZ	PC 41 BRUSH	PC 49 ORCHESTRA #
C1 22	←	←	←	←
23	←	←	←	←
C1 24	←	←	←	←
25	←	←	←	←
26	←	Finger Snap 2	Finger Snap 2	Finger Snap
27	←	←	←	Closed Hi-Hat 2 [EXC1]
28	←	←	←	Pedal Hi-Hat [EXC1]
29	Scratch Push 2 [EXC7]	←	←	Open Hi-Hat 2 [EXC1]
30	Scratch Pull 2 [EXC7]	←	←	Ride Cymbal 1
31	←	←	←	←
32	←	←	←	←
33	←	←	←	←
34	←	←	←	←
35	←	←	←	←
C2 36	TR-909 Kick 2	Jazz Kick 2	Jazz Kick 2	Jazz Kick 1
37	TR-909 Kick 1 *	Jazz Kick 1	Jazz Kick 1	Concert BD 1
38	TR-909 Rim	←	←	←
39	TR-909 Snare 1	Jazz Snare 1	Brush Tap 1	Concert SD
40	←	Hand Clap 2	Brush Slap 1	Castanets
41	TR-909 Snare2	Jazz Snare 2	Brush Swirl 1	Concert SD
42	TR-909 Low Tom 2	←	Brush Low Tom 2 *	Timpani F
43	TR-707 Closed Hi-Hat [EXC1]	Closed Hi-Hat 2 [EXC1]	Brush Closed Hi-Hat [EXC1]	Timpani F#
44	TR-909 Low Tom 1	←	Brush Low Tom 1 *	Timpani G
45	TR-707 Closed Hi-Hat [EXC1]	Pedal Hi-Hat [EXC1]	Pedal Hi-Hat [EXC1]	Timpani G#
46	TR-909 Mid Tom 2	←	Brush Mid Tom 2 *	Timpani A
47	TR-909 Open Hi-Hat [EXC1]	Open Hi-Hat 2 [EXC1]	Brush Open Hi-Hat [EXC1]	Timpani A#
C3 48	TR-909 Mid Tom 1	←	Brush Mid Tom 1 *	Timpani B
49	TR-909 High Tom 2	←	Brush High Tom 2 *	Timpani c
50	TR-909 Crash Cymbal	←	Brush Crash Cymbal	Timpani c#
51	TR-909 High Tom 1	←	Brush High Tom 1 *	Timpani d
52	TR-909 Ride Cymbal *	Ride Cymbal Inner	Ride Cymbal Inner	Timpani d#
53	←	←	←	Timpani e
54	←	←	Brush Ride Bell	Timpani f
55	Tambourine 2	←	←	←
56	←	←	←	←
57	TR-808 Cowbell	←	←	←
58	←	←	←	Concert Cymbal 2
59	←	←	←	←
C4 60	Ride Cymbal Edge	Ride Cymbal Edge	Ride Cymbal Edge	Concert Cymbal 1
61	←	←	←	←
62	←	←	←	←
63	←	←	←	←
64	←	←	←	←
65	←	←	←	←
66	←	←	←	←
67	←	←	←	←
68	←	←	←	←
69	←	←	←	←
70	TR-808 Maracas	←	←	←
71	←	←	←	←
C5 72	←	←	←	←
73	←	←	←	←
74	CR-78 Guiro [EXC3]	←	←	←
75	TR-808 Claves	←	←	←
76	←	←	←	←
77	←	←	←	←
78	High Hoo [EXC4]	←	←	←
79	Low Hoo [EXC4]	←	←	←
80	Mute Triangle	←	←	←
81	Open Triangle	←	←	←
82	TR-626 Shaker	←	←	←
83	←	←	←	←
C6 84	←	←	←	←
85	←	←	←	←
86	←	←	←	←
87	←	←	←	←
88	←	Applause *	Applause *	Applause *
89	---	---	---	---
90	---	---	---	---
91	---	---	---	---
92	---	---	---	---
93	---	---	---	---
94	---	---	---	---
95	---	---	---	---
C7 96	---	---	---	---

Note Number

PC : Program Number (Drum Set Number) ← : Same as the percussion sound of "STANDARD1"(PC1). [88] : Same as the percussion sound of SC-88
 --- : No sound [EXC] : Percussion sound of the same number will not be heard at the same time. [55] : Same as the percussion sound of SC-55
 * : Tones which are created using two voices

Native Drum set (5)

#: Same Drum Set as SC-88 map

	PC 50	PC 51	PC 53	PC 54			
	ETHNIC #	KICK & SNARE #	ASIA	CYMBAL&CLAPS			
	25	Finger Snap	CR-78 Kick 1	Gamelan Gong 1	---		
26		Tambourine	CR-78 Kick 2	Gamelan Gong 2	---		
	27	Castanets	TR-606 Kick	Gamelan Gong 3	---		
28		Crash Cymbal 1	TR-707 Kick	Gamelan Gong 4	---		
		Snare Roll	TR-808 Kick 1	Gamelan Gong 5	---		
29	30	Concert SD	TR-909 Kick 1	Gamelan Gong 6	---		
		Concert Cymbal	TR-909 Kick 2	*	Gamelan Gong 7	---	
31	32	Concert BD 1	Hip-Hop Kick 2	Gamelan Gong 8	Reverse Open Hi-Hat		
33		Jingle Bell	Hip-Hop Kick 1	Gamelan Gong 9	Reverse Closed Hi-Hat 1		
	34	Bell Tree	Jungle Kick 2	Gamelan Gong 10	Reverse Closed Hi-Hat 2		
		Bar Chimes	Jungle Kick 1	Gender 1	Jungle Hi-Hat	[EXC1]	
C2	36	Wadaiko	* Techno Kick 2	Gender 2	[55] Closed Hi-Hat	[EXC1]	
	37	Wadaiko Rim	* Techno Kick 1	Gender 3	[88] Closed Hi-Hat 2	[EXC1]	
	38	Shime Taiko	Standard 1 Kick 2	Gender 4	[88] Closed Hi-Hat 3	[EXC1]	
	39	Atarigane	Standard 1 Kick 1	Gender 5	Closed Hi-Hat 4	[EXC1]	
		Hyoushigi	[88] Standard 1 Kick 1	Bonang 1	Closed Hi-Hat	[EXC1]	
	41	Ohkawa	[88] Standard 1 Kick 2	Bonang 2	TR-707 Closed Hi-Hat	[EXC1]	
	42	High Kotsuzumi	[88] Standard 2 Kick 1	Bonang 3	TR-606 Closed Hi-Hat	[EXC1]	
	43	Low Kotsuzumi	[88] Standard 2 Kick 2	Bonang 4	[88] TR-808 Closed Hi-Hat	[EXC1]	
	44	Ban Gu	[55] Kick Drum 1	Bonang 5	TR-808 Closed Hi-Hat	[EXC1]	
	45	Big Gong	[55] Kick Drum 2	Rama Cymbal Low	CR-78 Closed Hi-Hat	[EXC1]	
	46	Small Gong	[88] Soft Kick	Rama Cymbal High	[55] Pedal Hi-Hat	[EXC1]	
		Bend Gong	[88] Jazz Kick 1	Sagat Open	[EXC7] [88] Pedal Hi-Hat	[EXC1]	
C3	48	Thai Gong	[88] Jazz Kick 2	Sagat Closed	[EXC7] Pedal Hi-Hat	[EXC1]	
	49	Rama Cymbal	[55] Concert BD 1	Jaws Harp	Half-Open Hi-Hat 1	[EXC1]	
	50	Gamelan Gong	[88] Room Kick 1	Wadaiko	*	Half-Open Hi-Hat 2	[EXC1]
	51	Udo Short	[EXC1] [88] Room Kick 2	Wadaiko Rim	*	[55] Open Hi Hat	[EXC1]
	52	Udo Long	[EXC1] [88] Power Kick1	Small Taiko	[88] Open Hi-Hat 2	[EXC1]	
	53	Udo Slap	[88] Power Kick2	Shimedaiko	[88] Open Hi-Hat 3	[EXC1]	
	54	Bendir	[88] Electric Kick 2	Atarigane	Open Hi-Hat 2	[EXC1]	
	55	Req Dum	[88] Electric Kick 1	*	Hyoushigi	TR-909 Open Hi-Hat	[EXC1]
	56	Req Tik	[55] Electric Kick	Ohkawa	TR-707 Open Hi-Hat	[EXC1]	
	57	Tabla Te	[88] TR-808 Kick	High Kotsuzumi	TR-606 Open Hi-Hat	[EXC1]	
	58	Tabla Na	[88] TR-909 Kick	Low Kotsuzumi	[88] TR-808 Open Hi-Hat	[EXC1]	
		Tabla Tun	[88] Dance Kick	Yyoo Dude	TR-808 Open Hi-Hat	[EXC1]	
C4	60	Tabla Ge	[88] Standard 1 Snare 1	Buk	CR-78 Open Hi-Hat	[EXC1]	
	61	Tabla Ge Hi	[88] Standard 1 Snare 2	Buk Rim	Crash Cymbal 1	[EXC3]	
	62	Talking Drum	* [88] Standard 2 Snare 1	Gengari p	[EXC1] Crash Cymbal 2	[EXC4]	
	63	Bend Talking Drum	* [88] Standard 2 Snare 2	Gengari Mute Low	[EXC1] Crash Cymbal 3		
	64	Caxixi	[55] Tight Snare	Gengari f	[EXC2] Brush Crash Cymbal		
	65	Djembe	[55] Concert Snare	Gengari Mute High	[EXC2] Hard Crash Cymbal	*	
	66	Djembe Rim	[88] Jazz Snare 1	Gengari Samll	TR-909 Crash Cymbal		
	67	Timbales Low	[88] Jazz Snare 2	Jang-Gu Che	TR-808 Crash Cymbal		
	68	Timbales Paila	[88] Room Snare 1	Jang-Gu Kun	Mute Crash Cymbal 1	[EXC3]	
	69	Timbales High	[88] Room Snare 2	Jang-Gu Rim	Mute Crash Cymbal 2	[EXC4]	
	70	Cowbell	[88] Power Snare 1	Jing p	[EXC3] Reverse Crash Cymbal 1		
		High Bongo	[88] Power Snare 2	Jing f	* [EXC3] Reverse Crash Cymbal 2		
C5	72	Low Bongo	[55] Gated Snare	Jing Mute	[EXC3] Reverse Crash Cymbal 3		
	73	Mute High Conga	[88] Dance Snare 1	Asian Gong	Reverse TR-909 Crash Cymbal		
	74	Open High Conga	[88] Dance Snare 2	Big Gong	[55] Splash Cymbal		
	75	Mute Low Conga	[88] Disco Snare	Small Gong	Splash Cymbal		
		Conga Slap	[88] Electric Snare 2	Pai Ban	[88] Ride Bell		
	77	Open Low Conga	[88] House Snare	*	Ban Gu	[88] Brush Ride Bell	
	78	Conga Slide	* [55] Electric Snare 1	Tang Gu	[EXC4] [88] Ride Cymbal 1		
	79	Mute Pandiero	[88] Electric Snare 3	*	Tang Gu Mute	[EXC4] [88] Ride Cymbal 2	
	80	Open Pandiero	[88] TR-808 Snare 1	Shou Luo	*	[88] Brush Ride Cymbal	
	81	Open Surdo	[EXC2] [88] TR-808 Snare 2	*	Bend Gong	Ride Cymbal Low Inner	
	82	Mute Surdo	[EXC2] [88] TR-909 Snare 1	Hu Yin Luo Low	*	Ride Cymbal Mid Inner	
		Tamborim	[88] TR-909 Snare 2	*	Hu Yin Luo Mid	[EXC5] Ride Cymbal High Inner	
C6	84	High Agogo	[88] Brush Tap 1	Hu Yin Luo Mid 2	[EXC5] Ride Cymbal Low Edge		
	85	Low Agogo	[88] Brush Tap 2	Hu Yin Luo High	[EXC6] Ride Cymbal Mid Edge		
	86	Shaker	[88] Brush Slap 1	Hu Yin Luo High 2	[EXC6] Ride Cymbal High Edge		
	87	High Whistle	[EXC3] [88] Brush Slap 2	Nao Bo	TR-606 Ride Cymbal		
	88	Low Whistle	[EXC3] [88] Brush Slap 3	Xiao Bo	TR-808 Ride Cymbal		
	89	Mute Cuica	[EXC4] [88] Brush Swirl 1	---	Chinese Cymbal		
	90	Open Cuica	[EXC4] [88] Brush Swirl 2	---	Chinese Cymbal 2		
	91	Mute Triangle	[EXC5] [88] Brush Long Swirl	---	[55] Hand Clap		
	92	Open Triangle	[EXC5] Standard 1 Snare 1	---	[88] Hand Clap 2		
	93	Short Guiro	[EXC6] Standard 1 Snare 2	---	[88] Hand Clap		
	94	Long Guiro	[EXC6] Standard 1 Snare 3	---	Hand Clap		
		Cabasa Up	Rap Snare	---	Hand Clap 2		
C7	96	Cabasa Down	Hip-Hop Snare 2	---	TR-707 Hand Clap		
	97	Claves	Jungle Snare 1	---	---		
	98	High Wood Block	Jungle Snare 2	---	---		
	99	Low Wood Block	Techno Snare 1	---	---		

↑
Note Number

PC : Program Number (Drum Set Number) ← : Same as the percussion sound of *STANDARD1*(PC1). [88] : Same as the percussion sound of SC-88
 --- : No sound [EXC] : Percussion sound of the same number will not be heard at the same time. [55] : Same as the percussion sound of SC-55
 * : Tones which are created using two voices

Native Drum set (6)

#: Same Drum Set as SC-88 map

	PC 57	PC 58	PC 59
	SFX	RHYTHM FX #	RHYTHM FX 2
C1	21	MC-500 Beep 1	---
	22	MC-500 Beep 2	---
	23	Guitar Slide	---
	24	Guitar Wah	---
	25	Guitar Slap	---
	26	Chord Stroke Down	---
	27	Chord Stroke Up	---
	28	Biwa FX *	---
	29	Phonograph Noise	---
	30	Tape Rewind	---
	31	Scratch Push 2 [EXC1]	---
	32	Scratch Pull 2 [EXC1]	---
	33	Cutting Noise 2 Up	---
	34	Cutting Noise 2 Down	---
	35	Distortion Guitar Cutting Noise Up	---
C2	36	Distortion Guitar Cutting Noise Down	Reverse Kick 1
	37	Bass Slide	Reverse TR-707 Kick 1
	38	Pick Scrape	Reverse Concert Bass Drum
	39	High Q	Reverse Power Kick1
	40	Slap	Reverse Electric Kick 1
	41	Scratch Push [EXC7]	Reverse Snare 1
	42	Scratch Pull [EXC7]	Reverse Snare 2
	43	Sticks	Reverse Standard 1 Snare 1
	44	Square Click	Reverse CR-78 Snare 1
	45	Metronome Click	Reverse Tight Snare
	46	Metronome Bell	Reverse Dance Snare
	47	Guitar Fret Noise	Reverse 808 Snare
C3	48	Guitar Cutting Noise Up	Reverse Tom 1
	49	Guitar Cutting Noise Down	Reverse Tom 2
	50	String Slap of Double Bass	Reverse Sticks
	51	Flute Key Click Noise	Reverse Slap
	52	Laughing	Reverse Cymbal 1
	53	Screaming	Reverse Cymbal 2
	54	Punch	Reverse Open Hi-Hat
	55	Heart Beat	Reverse Ride Cymbal
	56	Footsteps 1	Reverse CR-78 Open Hi-Hat
	57	Footsteps 2	Reverse Closed Hi-Hat
	58	Applause *	Reverse Closed Hi-Hat
	59	Door Creaking	Reverse House Snare
C4	60	Door	Reverse TR-707 Snare 1
	61	Scratch	Reverse Hip-Hop Snare 2
	62	Wind Chimes *	Reverse CR-78 Snare 2
	63	Car - Engine	Reverse TR-707 Snare 2
	64	Car - Stop	Reverse Jungle Snare 1
	65	Car - Passing	Reverse Jungle Snare 2
	66	Car - Crash *	Reverse Techno Snare 2
	67	Siren	Reverse TR-707 Snare
	68	Train	Reverse TR-606 Snare 1
	69	Jetplane *	Reverse TR-909 Snare 1
	70	Helicopter	Reverse Hip-Hop Snare 2
	71	Starship *	Reverse String Slap of Double Bass
C5	72	Gun Shot	Reverse Flute Key Click Noise
	73	Machine Gun	Reverse Laughing
	74	Laser Gun	Reverse Screaming
	75	Explosion *	Reverse Punch
	76	Dog	Reverse Heart Beat
	77	Horse-Gallop	Reverse Footsteps 1
	78	Birds *	Reverse Footsteps 2
	79	Rain	Reverse Applause *
	80	Thunder	Reverse Door Creaking
	81	Wind	Reverse Door
	82	Seashore	Reverse Scratch
	83	Stream	Reverse Wind Chimes *
C6	84	Bubble *	Reverse Car - Engine
	85	Kitty	Reverse Car - Stop
	86	Bird 2	Reverse Car - Passing
	87	Growl	Reverse Car - Crash *
	88	←	Reverse Siren
	89	Telephone 1	Reverse Train
	90	Telephone 2	Reverse Jetplane *
	91	Small Club 1 *	Reverse Helicopter
	92	Small Club 2 *	Reverse Starship *
	93	Applause Wave *	Reverse Gun Shot
	94	Eruption	Reverse Machine Gun
	95	Big Shot *	Reverse Laser Gun
C7	96	Percussion Bang *	Reverse Explosion *

Note Number

PC : Program Number (Drum Set Number) ← : Same as the percussion sound of "STANDARD1"(PC1). [88] : Same as the percussion sound of SC-88
 --- : No sound [EXC] : Percussion sound of the same number will not be heard at the same time. [55] : Same as the percussion sound of SC-55
 * : Tones which are created using two voices

Native Drum set (7)

Notes 0-19 and 97-127 are as follows.

		PC10 Hip-Hop	PC11 JUNGLE	PC12 TECHNO	PC25 ELECTRONIC	PC26 TR-808	PC27 DANCE	PC28 CR-78	PC29 TR-606	PC30 TR-707	PC31 TR-909	PC33 JAZZ	PC41 BRUSH	PC49 ORCHESTRA	PC51 KICK & SNARE	
		PC1 STANDARD 1	PC2 STANDARD 2	PC3 STANDARD 3	PC9 ROOM	PC17 POWER	PC30 TR-707	PC31 TR-909	PC33 JAZZ	PC41 BRUSH	PC49 ORCHESTRA	PC51 KICK & SNARE				
C-1	0	[88] Standard 1 Kick 1	[88] Electric Kick 2	←	←	---										
	1	[88] Standard 1 Kick 2	[88] Electric Kick 1 *	←	←	---										
	2	[88] Standard 2 Kick 1	CR-78 Kick 1	←	←	---										
	3	[88] Standard 2 Kick 2	CR-78 Kick 2	←	←	---										
	4	[55] Kick Drum 1	TR-606 Kick1	←	←	---										
	5	[55] Kick Drum 2	TR-707 Kick 1	←	←	---										
	6	[88] Jazz Kick 1	[55] TR-808 Kick	←	←	---										
	7	[88] Jazz Kick 2	[88] TR-808 Kick	←	←	---										
	8	[88] Room Kick 1	TR-808 Kick 2	←	←	---										
	9	[88] Room Kick 2	[88] TR-909 Kick	←	←	---										
C0	10	[88] Power Kick 1	[88] Dance Kick	←	←	---										
	11	[88] Power Kick 2	Hip-Hop Kick 2	←	←	---										
	12	[88] Electric Kick 2	TR-909 Kick 1 *	←	←	---										
	13	[88] Electric Kick 1 *	Hip-Hop Kick 3	←	←	---										
	14	[88] TR-808 Kick	Jungle Kick 1	←	←	---										
	15	[88] TR-909 Kick	Techno Kick 1	←	←	---										
	16	[88] Dance Kick	Bounce Kick	←	←	---										
	17	Voice One	←	←	←	---										
	18	Voice Two	←	←	←	---										
	19	Voice Three	←	←	←	---										
:																
C8	97	[88] Standard 1 Snare1	Techno Hit	---	Applause 2	*	Jungle Snare 1									
	98	[88] Standard 1 Snare 2	Philly Hit	*	Small Club 1	*	Jungle Snare 2									
	99	[88] Standard 2 Snare 1	Impact Hit	*	[55] Timpani D#	Techno Snare 1										
	100	[88] Standard 2 Snare 2	Lo-Fi Rave	*	[88] Brush Tap 1	[55] Timpani E	Techno Snare 2									
	101	[55] Snare Drum 2	Bam Hit	[88] Brush Tap 2	[55] Timpani F	House Snare 2										
	102	Standard 1 Snare 1	Bim Hit	[88] Brush Slap 1	[55] Timpani F#	CR-78 Snare 1										
	103	Standard 1 Snare 2	Tape Rewind	[88] Brush Slap 2	[55] Timpani G	CR-78 Snare 2										
	104	Standard 1 Snare 3	Phonograph Noise	[88] Brush Slap 3	[55] Timpani G#	TR-606 Snare 1										
	105	[88] Jazz Snare 1	[88] Power Snare 1	[88] Brush Swirl 1	[55] Timpani A	TR-606 Snare 2										
	106	[88] Jazz Snare 2	[88] Dance Snare 1	[88] Brush Swirl 2	[55] Timpani A#	TR-707 Snare 1										
C9	107	[88] Room Snare 1	[88] Dance Snare 2	[88] Brush Long Swirl	[55] Timpani B	TR-707 Snare 2										
	108	[88] Room Snare 2	[88] Disco Snare	[88] Jazz Snare 1	[55] Timpani c	Standard 3 Snare 2										
	109	[88] Power Snare 1	[88] Electric Snare 2	[88] Jazz Snare 2	[55] Timpani c#	TR-808 Snare 2										
	110	[88] Power Snare 2	[55] Electric Snare	[88] Standard 1 Snare1	[55] Timpani d	TR-909 Snare 1										
	111	[55] Gated Snare	[88] Electric Snare 3 *	[88] Standard 1 Snare2	[55] Timpani d#	TR-909 Snare 2										
	112	[88] Dance Snare 1	TR-606 Snare 2	[88] Standard 2 Snare1	[55] Timpani e	---										
	113	[88] Dance Snare 2	TR-707 Snare 1	[88] Standard 2 Snare2	[55] Timpani f	---										
	114	[88] Disco Snare	[88] TR-808 Snare 2	[55] Snare Drum 2	---	---										
	115	[88] Electric Snare 2	[88] TR-808 Snare 1 *	Standard 1 Snare 1	---	---										
	116	[55] Electric Snare	TR-808 Snare 2	Standard 1 Snare 2	---	---										
C9	117	[88] Electric Snare 3 *	[88] TR-909 Snare 1	Standard 1 Snare 3	---	---										
	118	TR-707 Snare 1	[88] TR-909 Snare 2 *	[88] Room Snare 1	---	---										
	119	[88] TR-808 Snare 1	TR-909 Snare 1	[88] Room Snare 2	---	---										
	120	[88] TR-808 Snare 2 *	TR-909 Snare 2	[88] Power Snare 1	---	---										
	121	[88] TR-909 Snare 1	Rap Snare	[88] Power Snare 2	---	---										
	122	[88] TR-909 Snare 2 *	Jungle Snare	[88] Gated Snare	---	---										
	123	Rap Snare	House Snare 1	[88] Dance Snare 1	---	---										
	124	Jungle Snare 1	[88] House Snare *	[88] Dance Snare 2	---	---										
	125	House Snare 1	House Snare 2	[88] Disco Snare	---	---										
	126	[88] House Snare *	Voice Tah	[88] Electric Snare 2	---	---										
127	House Snare 2	[88] Slappy *	[88] Electric Snare 3 *	---	---											

PC : Program Number (Drum Set Number) ← : Same as the percussion sound of *STANDARD1*(PC1). [88] : Same as the percussion sound of SC-88
 --- : No sound [EXC]: Percussion sound of the same number will not be heard at the same time. [55] : Same as the percussion sound of SC-55
 * : Tones which are created using two voices

SC-88 Drum set (1)

	PC 1 STANDARD 1	PC 2 STANDARD 2	PC 9 ROOM	PC 17 POWER	PC 25 ELECTRONIC
25	Snare Roll	←	←	←	←
26	Finger Snap	←	←	←	←
27	High Q	←	←	←	←
28	Slap	←	←	←	←
29	Scratch Push [EXC7]	←	←	←	Scratch Push2 [EXC7]
30	Scratch Pull [EXC7]	←	←	←	Scratch Pull2 [EXC7]
31	Sticks	←	←	←	←
32	Square Click	←	←	←	←
33	Metronome Click	←	←	←	←
34	Metronome Bell	←	←	←	←
35	Standard 1 Kick 2	Standard 2 Kick 2	Room Kick 2	Power Kick 2	Electric Kick 2
36	Standard 1 Kick 1	Standard 2 Kick 1	Room Kick 1	Power Kick 1	Electric Kick 1
37	Side Stick	←	←	←	←
38	Standard 1 Snare 1	Standard 2 Snare 1	Room Snare 1	Power Snare 1	Electric Snare 1
39	Hand Clap	←	←	←	←
40	Standard 1 Snare 2	Standard 2 Snare 2	Room Snare 2	PowerSnare 2	Electric Snare 2
41	Low Tom2 *	←	Room Low Tom2 *	Power Low Tom2 *	Electric Low Tom2 *
42	Closed Hi-hat1 [EXC1]	Closed Hi-hat2 [EXC1]	Closed Hi-hat3 [EXC1]	Closed Hi-hat3 [EXC1]	Closed Hi-hat2 [EXC1]
43	Low Tom1 *	←	Room Low Tom1 *	Power Low Tom1 *	Electric Low Tom1 *
44	Pedal Hi-hat [EXC1]	←	←	←	←
45	Mid Tom2 *	←	Room Mid Tom2 *	Power Mid Tom2 *	Electric Mid Tom2 *
46	Open Hi-hat1 [EXC1]	Open Hi-hat2 [EXC1]	Open Hi-hat3 [EXC1]	Open Hi-hat3 [EXC1]	Open Hi-hat2 [EXC1]
47	Mid Tom1 *	←	Room Mid Tom1 *	Power Mid Tom1 *	Electric Mid Tom1 *
48	High Tom2 *	←	Room Hi Tom2 *	Power Hi Tom2 *	Electric Hi Tom2 *
49	Crash Cymbal1	←	←	←	←
50	High Tom1 *	←	Room Hi Tom1 *	Power Hi Tom1 *	Electric Hi Tom1 *
51	Ride Cymbal1	←	←	←	←
52	Chinese Cymbal	←	←	←	Reverse Cymbal
53	Ride Bell	←	←	←	←
54	Tambourine	←	←	←	←
55	Splash Cymbal	←	←	←	←
56	Cowbell	←	←	←	←
57	Crash Cymbal2	←	←	←	←
58	Vibra-slap	←	←	←	←
59	Ride Cymbal2	←	←	←	←
60	High Bongo	←	←	←	←
61	Low Bongo	←	←	←	←
62	Mute High Conga	←	←	←	←
63	Open High Conga	←	←	←	←
64	Low Conga	←	←	←	←
65	High Timbale	←	←	←	←
66	Low Timbale	←	←	←	←
67	High Agogo	←	←	←	←
68	Low Agogo	←	←	←	←
69	Cabasa	←	←	←	←
70	Maracas	←	←	←	←
71	Short Hi Whistle [EXC2]	←	←	←	←
72	Long Low Whistle [EXC2]	←	←	←	←
73	Short Guiro [EXC3]	←	←	←	←
74	Long Guiro [EXC3]	←	←	←	←
75	Claves	←	←	←	←
76	High Wood Block	←	←	←	←
77	Low Wood Block	←	←	←	←
78	Mute Cuica [EXC4]	←	←	←	←
79	Open Cuica [EXC4]	←	←	←	←
80	Mute Triangle [EXC5]	←	←	←	←
81	Open Triangle [EXC5]	←	←	←	←
82	Shaker	←	←	←	←
83	Jingle Bell	←	←	←	←
84	Bell Tree	Bar Chimes	←	←	←
85	Castanets	←	←	←	←
86	Mute Surdo [EXC6]	←	←	←	←
87	Open Surdo [EXC6]	←	←	←	←
88	----	----	----	----	----
89	----	----	----	----	----
90	----	----	----	----	----
91	----	----	----	----	----
92	----	----	----	----	----
93	----	----	----	----	----
94	----	----	----	----	----
95	----	----	----	----	----
96	----	----	----	----	----
97	----	----	----	----	----
98	----	----	----	----	----
99	----	----	----	----	----

↑
Note Number

PC : Program Number (Drum Set Number) ← : Same as the percussion sound of "STANDARD"(PC1). [88] : Same as the percussion sound of SC-88
 --- : No sound [EXC] : Percussion sound of the same number will not be heard at the same time. [55] : Same as the percussion sound of SC-55
 * : Tones which are created using two voices

SC-88 Drum set (2)

	PC 26 TR-808/909	PC 27 DANCE	PC 33 JAZZ	PC 41 BRUSH	PC 49 ORCHESTRA
	25	←	←	←	←
26	←	←	←	←	←
	27	←	←	←	Closed Hi-hat2 [EXC1]
28	←	←	←	←	Pedal Hi-hat [EXC1]
	29	Scratch Push2 [EXC7]	Scratch Push2 [EXC7]	←	Open Hi-hat2 [EXC1]
	30	Scratch Pull2 [EXC7]	Scratch Pull2 [EXC7]	←	Ride Cymbal1
31	←	←	←	←	←
	32	←	←	←	←
33	←	←	←	←	←
	34	←	←	←	←
35	←	←	←	←	←
	36	909 Bass Drum	Dance Kick	Jazz Kick 2	Jazz Kick 1
C2		808 Bass Drum	Electric Kick 2	Jazz Kick 1	Concert BD1
	37	808 Rim Shot	←	←	←
38	←	808 Snare 1	Dance Snare 1	Jazz Snare 1	Brush Tap1
	39	←	←	Hand Clap2	Brush Slap1
40	←	909 Snare 1	Dance Snare 2	Jazz Snare 2	Brush Swirl1
	41	808 Low Tom2 *	Electric Low Tom2 *	←	Brush Low Tom2 *
	42	808 CHH [EXC1]	CR-78 CHH [EXC1]	Closed Hi-hat2 [EXC1]	Brush Closed Hi-hat [EXC1]
43	←	808 Low Tom1 *	Electric Low Tom1 *	←	Brush Low Tom1 *
	44	808 CHH [EXC1]	808 CHH [EXC1]	←	←
45	←	808 Mid Tom2 *	Electric Mid Tom2 *	←	Brush Mid Tom2 *
	46	808 OHH [EXC1]	CR-78 OHH [EXC1]	Open Hi-hat2 [EXC1]	Brush Open Hi-hat [EXC1]
47	←	808 Mid Tom1 *	Electric Mid Tom1 *	←	Brush Mid Tom1 *
C3		808 Hi Tom2 *	Electric High Tom2 *	←	Brush Hi Tom2 *
	49	808 Cymbal	←	←	Brush Crash Cymbal
50	←	808 Hi Tom1	Electric High Tom1 *	←	Brush Hi Tom1 *
	51	←	←	←	Brush Ride Cymbal
52	←	←	←	←	Reverse Cymbal
	53	←	←	←	Brush Ride Bell
	54	←	←	←	←
55	←	←	←	←	←
	56	808 Cowbell	←	←	←
57	←	←	←	←	Concert Cymbal2
	58	←	←	←	←
59	←	←	←	←	Concert Cymbal1
C4		←	←	←	←
	61	←	←	←	←
62	←	808 High Conga	←	←	←
	63	808 Mid Conga	←	←	←
64	←	808 Low Conga	←	←	←
	65	←	←	←	←
66	←	←	←	←	←
67	←	←	←	←	←
	68	←	←	←	←
69	←	←	←	←	←
	70	808 Maracas	←	←	←
C5		←	←	←	←
	72	←	←	←	←
	73	←	←	←	←
74	←	←	←	←	←
	75	808 Claves	←	←	←
76	←	←	←	←	←
	77	←	←	←	←
	78	←	High Hoo [EXC4]	←	←
79	←	←	Low Hoo [EXC4]	←	←
	80	←	Electric Mute Triangle [EXC5]	←	←
81	←	←	Electric Open Triangle [EXC5]	←	←
	82	←	←	←	←
83	←	←	←	←	←
C6		←	←	←	←
	84	←	←	←	←
	85	←	←	←	←
86	←	←	←	←	←
	87	←	←	←	←
88	←	←	←	←	←
	89	←	←	←	Applause *
	90	←	←	←	←
91	←	←	←	←	←
	92	←	←	←	←
93	←	←	←	←	←
	94	←	←	←	←
95	←	←	←	←	←
C7		←	←	←	←
	96	←	←	←	←
	97	←	←	←	←
98	←	←	←	←	←
	99	←	←	←	←

↑
Note Number

PC : Program Number (Drum Set Number) ← : Same as the percussion sound of "STANDARD"(PC1). [88] : Same as the percussion sound of SC-88
 --- : No sound [EXC] : Percussion sound of the same number will not be heard at the same time. [55] : Same as the percussion sound of SC-55
 * : Tones which are created using two voices

SC-88 Drum set (3)

	PC 50 ETHNIC	PC 51 KICK&SNARE	PC 57 SFX	PC 58 RHYTHM FX
25	Finger Snap	----	----	----
26	Tambourine	----	----	----
27	Castanets	----	----	----
28	Crash Cymbal1	----	----	----
29	Snare Roll	----	----	----
30	Concert Snare Drum	----	----	----
31	Concert Cymbal	----	Scratch Push2 [EXC1]	----
32	Concert BD1	----	Scratch Pull2 [EXC1]	----
33	Jingle Bell	----	Cutting Noise 2 Up	----
34	Bell Tree	----	Cutting Noise 2 Down	----
	Bar Chimes	----	Distortion Guitar Cutting Noise Up	----
C2 36	Wadaiko *	----	Distortion Guitar Cutting Noise Down	Reverse Kick 1
37	Wadaiko Rim *	----	Bass Slide	Reverse Concert BD 1
38	Shime Taiko	----	Pick Scrape	Reverse Power Kick 1
39	Atarigane	----	High Q	Reverse Electric Kick 1
40	Hyoushigi	Standard 1 Kick 1	Slap	Reverse Snare 1
41	Ohkawa	Standard 1 Kick 2	Scratch Push [EXC7]	Reverse Snare 2
42	High Kotsuzumi	Standard 2 Kick 1	Scratch Pull [EXC7]	Reverse Standard set1 Snare 1
43	Low Kotsuzumi	Standard 2 Kick 2	Sticks	Reverse Tight Snare
44	Ban Gu	Kick 1	Square Click	Reverse Dance Snare
45	Big Gong	Kick 2	Metronome Click	Reverse 808 Snare
46	Small Gong	Soft Kick	Metronome Bell	Reverse Tom1
47	Bend Gong	Jazz Kick 1	Guitar Fret Noise	Reverse Tom2
C3 48	Thai Gong	Jazz Kick 2	Guitar Cutting Noise Up	Reverse Sticks
49	Rama Cymbal	Concert BD	GuitarCutting Noise Down	Reverse Slap
50	Gamelan Gong	Room Kick 1	String Slap of Double Bass	Reverse Cymbal1
51	Udo Short [EXC1]	Room Kick 2	Fl.Key Click	Reverse Cymbal2
52	Udo Long [EXC1]	Power Kick 1	Laughing	Reverse Open Hi-hat
53	Udo Slap	Power Kick 2	Scream	Reverse Ride Cymbal
54	Bendir	Electric Kick 2	Punch	Reverse CR-78 OHH
55	Req Dum	Electric Kick 1 *	Heart Beat	Reverse Closed Hi-hat
56	Req Tik	Electric Kick	Footsteps1	Reverse Gong
57	Tabla Te	808 Bass Drum	Footsteps2	Reverse Bell Tree
58	Tabla Na	909 Bass Drum	Applause *	Reverse Guiro
59	Tabla Tun	Dance Kick	Door Creaking	Reverse Bendir
C4 60	Tabla Ge	Standard 1 Snare 1	Door	Reverse Gun Shot
61	Tabla Ge Hi	Standard 1 Snare 2	Scratch	Reverse Scratch
62	Talking Drum *	Standard 2 Snare 1	Wind Chimes *	Reverse Laser
63	Bend Talking Drum *	Standard 2 Snare 2	Car-Engine	Key Click
64	Caxixi	Tight Snare	Car-Stop	Tekno Thip
65	Djembe	Concert Snare	Car-Pass	Pop Drop
66	Djembe Rim	Jazz Snare 1	Car-Crash *	Woody Slap
67	Timbales Low	Jazz Snare 2	Siren	Distortion Kick *
68	Timbales Paila	Room Snare 1	Train	Syn.Drop
69	Timbales High	Room Snare 2	Jetplane *	Reverse High Q
70	Cowbell	Power Snare 1	Helicopter	Pipe
71	Hi Bongo	Power Snare 2	Starship *	Ice Block
C5 72	Low Bongo	Gated Snare	Gun Shot	Digital Tambourine *
73	Mute Hi Conga	Dance Snare 1	Machine Gun	Alias
74	Open Hi Conga	Dance Snare 2	Lasergun	Modulated Bell
75	Mute Low Conga	Disco Snare	Explosion *	Spark
76	Conga Slap	Electric Snare2	Dog	Metalic Percussion
77	Open Low Conga	House Snare *	Horse-Gallop	Velocity Noise FX
78	Conga Slide *	Electric Snare 1	Birds *	Stereo Noise Clap *
79	Mute Pandiero	Electric Snare 3 *	Rain	Swish
80	Open Pandiero	808 Snare 1	Thunder	Slappy *
81	Open Surdo [EXC2]	808 Snare 2 *	Wind	Voice Ou
82	Mute Surdo [EXC2]	909 Snare 1	Seashore	Voice Au
83	Tamborim	909 Snare 2 *	Stream	Hoo
C6 84	High Agogo	Brush Tap1	Bubble *	Tape Stop1 *
85	Low Agogo	Brush Tap2	Kitty	Tape Stop2 *
86	Shaker	Brush Slap1	Bird2	Missile *
87	High Whistle [EXC3]	Brush Slap2	Growl	Space Bird
88	Low Whistle [EXC3]	Brush Slap3	Applause2 *	Flying Monster
89	Mute Cuica [EXC4]	Brush Swirl1	Telephone1	----
90	Open Cuica [EXC4]	Brush Swirl2	Telephone2	----
91	Mute Triangle [EXC5]	Brush Long Swirl	----	----
92	Open Triangle [EXC5]	----	----	----
93	Short Guiro [EXC6]	----	----	----
94	Long Guiro [EXC6]	----	----	----
95	Cabasa Up	----	----	----
C7 96	Cabasa Down	----	----	----
97	Claves	----	----	----
98	High Wood Block	----	----	----
99	Low Wood Block	----	----	----

↑
Note Number

PC : Program Number (Drum Set Number)

---- : No sound

* : Tones which are created using two voices

← : Same as the percussion sound of "STANDARD"(PC1).

[EXC] : Percussion sound of the same number will not be heard at the same time.

[88] : Same as the percussion sound of SC-88

[55] : Same as the percussion sound of SC-55

SC-55 Drum set

	PC 1 / PC 33 STANDARD / JAZZ	PC 9 ROOM	PC 17 POWER	PC 25 ELECTRONIC	PC 26 TR-808	PC 41 BRUSH	PC 49 ORCHESTRA
25	---	---	---	---	---	---	---
26	---	---	---	---	---	---	---
27	High Q	←	←	←	←	←	Closed Hi-hat [EXC1]
28	Slap	←	←	←	←	←	Pedal Hi-hat [EXC1]
29	Scratch Push	←	←	←	←	←	Open Hi-hat [EXC1]
30	Scratch Pull	←	←	←	←	←	Ride Cymbal1
31	Sticks	←	←	←	←	←	←
32	Square Click	←	←	←	←	←	←
33	Metronome Click	←	←	←	←	←	←
34	Metronome Bell	←	←	←	←	←	←
35	Kick Drum2 / Jazz BD2	←	←	←	←	Jazz BD2	Concert BD2
C2 36	Kick Drum1 / Jazz BD1	←	MONDO Kick	Elec BD	808 Bass Drum	Jazz BD1	Concert BD1
37	Side Stick	←	←	←	808 Rim Shot	←	←
38	Snare Drum1	←	Gated SD	Elec SD	808 Snare Drum	Brush Tap	Concert SD
39	Hand Clap	←	←	←	←	Brush Slap	Castanets
40	Snare Drum2	←	←	Gated SD	←	Brash Swirl	Concert SD
41	Low Tom2	Room Low Tom2	Room Low Tom2	Elec Low Tom2	808 Low Tom2	←	Timpani F
42	Closed Hi-hat [EXC1]	←	←	←	808 CHH [EXC1]	←	Timpani F#
43	Low Tom1	Room Low Tom1	Room Low Tom1	Elec Low Tom1	808 Low Tom1	←	Timpani G
44	Pedal Hi-hat [EXC1]	←	←	←	808 CHH [EXC1]	←	Timpani G#
45	Mid Tom2	Room Mid Tom2	Room Mid Tom2	Elec Mid Tom2	808 Mid Tom2	←	Timpani A
46	Open Hi-hat [EXC1]	←	←	←	808 OHH [EXC1]	←	Timpani A#
47	Mid Tom1	Room Mid Tom1	Room Mid Tom1	Elec Mid Tom1	808 Mid Tom1	←	Timpani B
C3 48	High Tom2	Room Hi Tom2	Room Hi Tom2	Elec Hi Tom2	808 Hi Tom2	←	Timpani c
49	Crash Cymbal1	←	←	←	808 Cymbal	←	Timpani c#
50	High Tom1	Room Hi Tom1	Room Hi Tom1	Elec Hi Tom1	808 Hi Tom1	←	Timpani d
51	Ride Cymbal1	←	←	←	←	←	Timpani d#
52	Chinese Cymbal	←	←	Reverse Cymbal	←	←	Timpani e
53	Ride Bell	←	←	←	←	←	Timpani f
54	Tambourine	←	←	←	←	←	←
55	Splash Cymbal	←	←	←	←	←	←
56	Cowbell	←	←	←	808 Cowbell	←	←
57	Crash Cymbal2	←	←	←	←	←	Concert Cymbal2
58	Vibra-slap	←	←	←	←	←	←
59	Ride Cymbal2	←	←	←	←	←	Concert Cymbal1
C4 60	High Bongo	←	←	←	←	←	←
61	Low Bongo	←	←	←	←	←	←
62	Mute High Conga	←	←	←	808 High Conga	←	←
63	Open High Conga	←	←	←	808 Mid Conga	←	←
64	Low Conga	←	←	←	808 Low Conga	←	←
65	High Timbale	←	←	←	←	←	←
66	Low Timbale	←	←	←	←	←	←
67	High Agogo	←	←	←	←	←	←
68	Low Agogo	←	←	←	←	←	←
69	Cabasa	←	←	←	←	←	←
70	Maracas	←	←	←	808 Maracas	←	←
71	Short Hi Whistle [EXC2]	←	←	←	←	←	←
C5 72	Long Low Whistle [EXC2]	←	←	←	←	←	←
73	Short Guiro	←	←	←	←	←	←
74	Long Guiro	←	←	←	←	←	←
75	Claves	←	←	←	808 Claves	←	←
76	High Wood Block	←	←	←	←	←	←
77	Low Wood Block	←	←	←	←	←	←
78	Mute Cuica [EXC4]	←	←	←	←	←	←
79	Open Cuica [EXC4]	←	←	←	←	←	←
80	Mute Triangle [EXC5]	←	←	←	←	←	←
81	Open Triangle [EXC5]	←	←	←	←	←	←
82	Shaker	←	←	←	←	←	←
83	Jingle Bell	←	←	←	←	←	←
C6 84	Bell Tree	←	←	←	←	←	←
85	Castanets	←	←	←	←	←	←
86	Mute Surdo [EXC6]	←	←	←	←	←	←
87	Open Surdo [EXC6]	←	←	←	←	←	←
88	---	---	---	---	---	---	Applause *
89	---	---	---	---	---	---	---
90	---	---	---	---	---	---	---
91	---	---	---	---	---	---	---
92	---	---	---	---	---	---	---
93	---	---	---	---	---	---	---
94	---	---	---	---	---	---	---
95	---	---	---	---	---	---	---
C7 96	---	---	---	---	---	---	---
97	---	---	---	---	---	---	---
98	---	---	---	---	---	---	---
99	---	---	---	---	---	---	---

↑
Note Number

PC : Program Number (Drum Set Number)
 --- : No sound
 * : Tones which are created using two voices

← : Same as the percussion sound of "STANDARD"(PC1).
 [EXC] : Percussion sound of the same number will not be heard at the same time.

[88] : Same as the percussion sound of SC-88
 [55] : Same as the percussion sound of SC-55

SFX set , CM-64 / 32L Drum set

	PC 57	PC 128
	SFX	CM-64/32L
	35	---
	---	CM Kick Drum
C2	36	---
	---	CM Kick Drum
	37	---
	---	CM Rim Shot
	38	---
	---	CM Snare Drum
	39	High Q
	---	CM Hand Clap
	40	Slap
	---	CM Electronic Snare Drum
	41	Scratch Push [EXC7]
	---	CM Acoustic Low Tom
	42	Scratch Pull [EXC7]
	---	CM Closed High Hat [EXC1]
	43	Sticks
	---	CM Acoustic Low Tom
	44	Square Click
	---	CM Open Hi-Hat2
	45	Metronome Click
	---	CM Acoustic Middle Tom
	46	Metronome Bell
	---	CM Open Hi-Hat1 [EXC1]
	47	Guitar Fret Noise
	---	CM M.TomAcoustic Middle Tom
C3	48	Guitar cuttingnoise/up
	---	CM Acoustic High Tom
	49	Guitar cutting noise/down
	---	CM Crash Cymbal
	50	String slap of double bass
	---	CM Acoustic High Tom
	51	Fl.Key Click
	---	CM Ride Cymbal
	52	Laughing
	---	---
	53	Scream
	---	---
	54	Punch
	---	CM Tambourine
	55	Heart Beat
	---	---
	56	Footsteps1
	---	CM Cowbell
	57	Footsteps2
	---	---
	58	Applause *
	---	---
	59	Door Creaking
	---	---
C4	60	Door
	---	CM High Bongo
	61	Scratch
	---	CM Low Bongo
	62	Wind Chimes *
	---	CM Mute High Conga
	63	Car-Engine
	---	CM High Conga
	64	Car-Stop
	---	CM Low Conga
	65	Car-Pass
	---	CM High Timbale
	66	Car-Crash *
	---	CM Low Timbale
	67	Siren
	---	CM High Agogo
	68	Train
	---	CM Low Agogo
	69	Jetplane *
	---	CM Cabasa
	70	Helicopter
	---	CM Maracas
	71	Starship *
	---	CM Short Whistle
C5	72	Gun Shot
	---	CM Long Whistle
	73	Machine Gun
	---	CM Vibrato Slap
	74	Lasergun
	---	---
	75	Explosion *
	---	CM Claves
	76	Dog
	---	Laughing
	77	Horse-Gallop
	---	Scream
	78	Birds *
	---	Punch
	79	Rain *
	---	Heart Beat
	80	Thunder
	---	Footsteps1
	81	Wind
	---	Footsteps2
	82	Seashore
	---	Applause *
	83	Stream *
	---	Creaking
C6	84	Bubble *
	---	Door
	85	---
	---	Scratch
	86	---
	---	Wind Chimes *
	87	---
	---	Car-Engine
	88	---
	---	Car-Stop
	89	---
	---	Car-Pass
	90	---
	---	Car-Crash *
	91	---
	---	Siren
	92	---
	---	Train
	93	---
	---	Jetplane *
	94	---
	---	Helicopter
	95	---
	---	Starship *
C7	96	---
	---	Gun Shot
	97	---
	---	Machine Gun
	98	---
	---	Lasergun
	99	---
	---	Explosion *
	100	---
	---	Dog
	101	---
	---	Horse-Gallop
	102	---
	---	Birds *
	103	---
	---	Rain *
	104	---
	---	Thunder
	105	---
	---	Wind
	106	---
	---	SeaShore
	107	---
	---	Stream *
C8	108	---
	---	Bubble *

↑
Note Number

PC : Program Number (Drum Set Number)
 --- : No sound
 * : Tones which are created using two voices

← : Same as the percussion sound of "STANDARD"(PC1).
 [EXC] : Percussion sound of the same number will not be heard at the same time.

[88] : Same as the percussion sound of SC-88
 [55] : Same as the percussion sound of SC-55

Switching between Native map and either SC-88map or SC-55 map

Press the front panel button [SC-88MAP] to make the indicator light, and the SC-88map will be selected. (p.25)
 Press the front panel button [SC-55MAP] to make the indicator light, and the SC-55map will be selected. (p.25)

You can also use MIDI Bank Select messages to select one of the Native map, SC-88 map and SC-55 map. (p.126)

Effect list

Parameter Value (Dec.) Value (Hex.) min - max MSB/LSB(H)
0 : Thru 00 00

○ Effects that modify the tone color (filter type)

1 : Stereo-EQ 01 00			
Low Freq	200/400	00/01	03
Low Gain	-12 - +5 - +12	34 - 4C	04
Hi Freq	4k/8k	00/01	05
Hi Gain	-12 - +12	34 - 4C	06
M1 Freq	200 - 1.6k - 6.3k	*10	07
M1 Q	0.5/1.0/2.0/4.0/9.0	00/01/02/03/04	08
M1 Gain	-12 - +8 - +12	34 - 4C	09
M2 Freq	200 - 1k - 6.3k	*10	0A
M2 Q	0.5/1.0/2.0/4.0/9.0	00/01/02/03/04	0B
M2 Gain	-12 - +8 - +12	34 - 4C	0C
+ Level	0 - 127	00 - 7F	16

2 : Spectrum 01 01			
Band 1	-12 - -4 - +12	34 - 4C	03
Band 2	-12 - +1 - +12	34 - 4C	04
Band 3	-12 - +3 - +12	34 - 4C	05
Band 4	-12 - +6 - +12	34 - 4C	06
Band 5	-12 - +2 - +12	34 - 4C	07
Band 6	-12 - -1 - +12	34 - 4C	08
Band 7	-12 - -4 - +12	34 - 4C	09
Band 8	-12 - -5 - +12	34 - 4C	0A
Width	0.5/1.0/2.0/4.0/9.0	00/01/02/03/04	0B
+ Pan	L63 - 0 - R63	00 - 7F	15
# Level	0 - 127	00 - 7F	16

3 : Enhancer 01 02			
+ Sens	0 - 64 - 127	00 - 7F	03
# Mix	0 - 127	00 - 7F	04
Low Gain	-12 - +3 - +12	34 - 4C	13
Hi Gain	-12 - 0 - +12	34 - 4C	14
Level	0 - 127	00 - 7F	16

4 : Humanizer 01 03			
Drive	0 - 48 - 127	00 - 7F	03
Drive Sw	Off/On	00/01	04
+ Vowel	a/i/u/e/o	00/01/02/03/04	05
Accel	0 - 15	*14	06
Low Gain	-12 - 0 - +12	34 - 4C	13
Hi Gain	-12 - 0 - +12	34 - 4C	14
Pan	L63 - 0 - R63	00 - 7F	15
# Level	0 - 127	00 - 7F	16

○ Effects that distort the sound (distortion type)

5 : Overdrive 01 10			
+ Drive	0 - 48 - 127	00 - 7F	03
Amp Type	Small/Bltn/2-Stk/3-Stk	00/01/02/03	04
Amp Sw	Off/On	00/01	05
Low Gain	-12 - 0 - +12	34 - 4C	13
Hi Gain	-12 - 0 - +12	34 - 4C	14
# Pan	L63 - 0 - R63	00 - 7F	15
Level	0 - 96 - 127	00 - 7F	16

6 : Distortion 01 11			
+ Drive	0 - 76 - 127	00 - 7F	03
Amp Type	Small/Bltn/2-Stk/3-Stk	00/01/02/03	04
Amp Sw	Off/On	00/01	05
Low Gain	-12 - 0 - +12	34 - 4C	13
Hi Gain	-12 - +8 - +12	34 - 4C	14
# Pan	L63 - 0 - R63	00 - 7F	15
Level	0 - 84 - 127	00 - 7F	16

+: Effect control 1 can be used to modify the value (p.92)
#: Effect control 2 can be used to modify the value (p.92)
MSB/LSB: Indicates the ** portion of the following exclusive messages. (p.196) (hexadecimal notation)
For Effect Type (data section)
F0 41 dev 42 12 40 03 00 *** sum F7
For Effect Parameters (LSB part of address)
F0 41 dev 42 12 40 03 ** data sum F7
(dev: device ID, sum: checksum)

○ Effects that modulate the sound (modulation type)

7 : Phaser 01 20			
+ Manual	100 - 620 - 8k	*12	03
# Rate	0.05 - 0.85 - 10.0	*6	04
Depth	0 - 64 - 127	00 - 7F	05
Reso	0 - 16 - 127	00 - 7F	06
Mix	0 - 127	00 - 7F	07
Low Gain	-12 - 0 - +12	34 - 4C	13
Hi Gain	-12 - 0 - +12	34 - 4C	14
Level	0 - 104 - 127	00 - 7F	16

8 : Auto Wah 01 21			
Flt Type	LPF/BPF	00/01	03
Sens	0 - 127	00 - 7F	04
+ Manual	0 - 68 - 127	00 - 7F	05
Peak	0 - 62 - 127	00 - 7F	06
# Rate	0.05 - 2.05 - 10.0	*6	07
Depth	0 - 72 - 127	00 - 7F	08
Polarity	Down/Up	00/01	09
Low Gain	-12 - 0 - +12	34 - 4C	13
Hi Gain	-12 - 0 - +12	34 - 4C	14
Pan	L63 - 0 - R63	00 - 7F	15
Level	0 - 96 - 127	00 - 7F	16

9 : Rotary 01 22			
Low Slow	0.05 - 0.35 - 10.0	*6	03
Low Fast	0.05 - 6.40 - 10.0	*6	04
Low Accl	0 - 3 - 15	*14	05
Low Level	0 - 127	00 - 7F	06
Hi Slow	0.05 - 0.90 - 10.0	*6	07
Hi Fast	0.05 - 7.50 - 10.0	*6	08
Hi Accl	0 - 11 - 15	*14	09
Hi Level	0 - 64 - 127	00 - 7F	0A
Separate	0 - 96 - 127	00 - 7F	0B
+ Speed	Slow/Fast	00/7F	0D
Low Gain	-12 - 0 - +12	34 - 4C	13
Hi Gain	-12 - 0 - +12	34 - 4C	14
# Level	0 - 127	00 - 7F	16

10 : Stereo Flanger 01 23			
Pre Filter	Off/LPF/HPF	00/01/02	03
Cutoff	250 - 8k	*9	04
Pre Dly	0 - 1.6m - 100m	*1	05
+ Rate	0.05 - 0.60 - 10.0	*6	06
Depth	0 - 24 - 127	00 - 7F	07
# Feedback	-98% - +80% - +98%	0F - 71	08
Phase	0 - 180	00 - 5A	09
Balance	D> 0E - D=E - D 0<E	00 - 7F	12
Low Gain	-12 - 0 - +12	34 - 4C	13
Hi Gain	-12 - 0 - +12	34 - 4C	14
Level	0 - 104 - 127	00 - 7F	16

11 : Step Flanger 01 24			
Pre Dly	0 - 1.0m - 100m	*1	03
Rate	0.05 - 0.30 - 10.0	*6	04
Depth	0 - 95 - 127	00 - 7F	05
+ Feedback	-98% - +30% - +98%	0F - 71	06
Phase	0 - 180	00 - 5A	07
# Step Rate	0.05 - 2.75 - 10.0	*6	08
Balance	D> 0E - D=E - D 0<E	00 - 7F	12
Low Gain	-12 - 0 - +12	34 - 4C	13
Hi Gain	-12 - 0 - +12	34 - 4C	14
Level	0 - 96 - 127	00 - 7F	16

The correspondence between setting values and hexadecimal values for items in the Value column indicated with "*" is shown in the "Effect Data Table" (p. 183).

- *1 Pre Delay Time
- *2 Delay Time 1
- *3 Delay Time 2
- *4 Delay Time 3
- *5 Delay Time 4
- *6 Rate 1
- *7 Rate 2
- *8 HF Damp
- *9 Cutoff Freq
- *10 EQ Freq
- *11 LPF
- *12 Manual
- *13 Azimuth
- *14 Accl

Parameter	Value (Dec.)	Value (Hex.) min - max	MSB/LSB(H)
12 : Tremolo			01 25
Mod Wave	Tri/Sqr/Sin/Saw1/Saw2	00/01/02/03/04	03
+ Mod Rate	0.05 - 3.05 - 10.0	*6	04
# Mod Depth	0 - 96 - 127	00 - 7F	05
Low Gain	-12 - 0 - +12	34 - 4C	13
Hi Gain	-12 - 0 - +12	34 - 4C	14
Level	0 - 127	00 - 7F	16
13 : Auto Pan			01 26
Mod Wave	Tri/Sqr/Sin/Saw1/Saw2	00/01/02/03/04	03
+ Mod Rate	0.05 - 3.05 - 10.0	*6	04
# Mod Depth	0 - 96 - 127	00 - 7F	05
Low Gain	-12 - 0 - +12	34 - 4C	13
Hi Gain	-12 - 0 - +12	34 - 4C	14
Level	0 - 127	00 - 7F	16
○ Effects that affect the level (compressor type)			
14 : Compressor			01 30
Attack	0 - 72 - 127	00 - 7F	03
Sustain	0 - 100 - 127	00 - 7F	04
Post Gain	0 /+6/+12/+18	00/01/02/03	05
Low Gain	-12 - 0 - +12	34 - 4C	13
Hi Gain	-12 - 0 - +12	34 - 4C	14
+ Pan	L63 - 0 - R63	00 - 7F	15
# Level	0 - 104 - 127	00 - 7F	16
15 : Limiter			01 31
Threshold	0 - 85 - 127	00 - 7F	03
Ratio	1/1.5,1/2,1/4, 1/100	00/01/02/03	04
Release	0 - 16 - 127	00 - 7F	05
Post Gain	0 /+6/+12/+18	00/01/02/03	06
Low Gain	-12 - 0 - +12	34 - 4C	13
Hi Gain	-12 - 0 - +12	34 - 4C	14
+ Pan	L63 - 0 - R63	00 - 7F	15
# Level	0 - 127	00 - 7F	16
○ Effects that broaden the sound (chorus type)			
16 : Hexa Chorus			01 40
Pre Dly	0 - 2.4m - 100m	*1	03
+ Rate	0.05 - 0.45 - 10.0	*6	04
Depth	0 - 127	00 - 7F	05
Pre Dly Dev	0 - 5 - 20	00 - 14	06
Depth Dev	-20 - +2 - +20	2C - 54	07
Pan Dev	0 - 16 - 20	00 - 14	08
# Balance	D> 0E - D=E - D 0<E	00 - 7F	12
Low Gain	-12 - 0 - +12	34 - 4C	13
Hi Gain	-12 - 0 - +12	34 - 4C	14
Level	0 - 112 - 127	00 - 7F	16
17 : Tremolo Chorus			01 41
Pre Dly	0 - 1.6m - 100m	*1	03
Cho Rate	0.05 - 0.45 - 10.0	*6	04
Cho Depth	0 - 40 - 127	00 - 7F	05
Trem Phase	0 - 80 - 180	00 - 5A	06
+ Trem Rate	0.05 - 3.05 - 10.0	*6	07
Trem Sep	0 - 96 - 127	00 - 7F	08
# Balance	D> 0E - D 0<E	00 - 7F	12
Low Gain	-12 - 0 - +12	34 - 4C	13
Hi Gain	-12 - 0 - +12	34 - 4C	14
Level	0 - 127	00 - 7F	16
18 : Stereo Chorus			01 42
Pre Filter	Off /LPF/HPF	00/01/02	03
Cutoff	250 - 8k	*9	04
Pre Dly	0 - 1.0m - 100m	*1	05
+ Rate	0.05 - 0.45 - 10.0	*6	06
Depth	0 - 111 - 127	00 - 7F	07
Phase	0 - 180	00 - 5A	09
# Balance	D> 0E - D=E - D 0<E	00 - 7F	12
Low Gain	-12 - 0 - +12	34 - 4C	13
Hi Gain	-12 - 0 - +12	34 - 4C	14
Level	0 - 104 - 127	00 - 7F	16
19 : Space D			01 43
Pre Dly	0 - 3.2m - 100m	*1	03
+ Rate	0.05 - 0.45 - 10.0	*6	04
Depth	0 - 127	00 - 7F	05
Phase	0 - 180	00 - 5A	06
# Balance	D> 0E - D=E - D 0<E	00 - 7F	12
Low Gain	-12 - 0 - +12	34 - 4C	13
Hi Gain	-12 - 0 - +12	34 - 4C	14
Level	0 - 96 - 127	00 - 7F	16
20 : 3D Chorus			01 44
Pre Dly	0 - 1.0m - 100m	*1	03
+ Cho Rate	0.05 - 0.45 - 10.0	*6	04
Cho Depth	0 - 72 - 127	00 - 7F	05
Out	Speaker /Phones	00/01	11
# Balance	D> 0E - D=E - D 0<E	00 - 7F	12
Low Gain	-12 - 0 - +12	34 - 4C	13
Hi Gain	-12 - 0 - +12	34 - 4C	14
Level	0 - 80 - 127	00 - 7F	16
○ Effects that reverberate the sound (delay/reverb type)			
21 : Stereo Delay			01 50
Dly Tm L	0 - 150m - 500m	*4	03
Dly Tm R	0 - 300m - 500m	*4	04
+ Feedback	-98% - +48% - +98%	0F - 71	05
Fb Mode	Norm/ Cross	00/01	06
Phase L	Norm /Invert	00/01	07
Phase R	Norm /Invert	00/01	08
HF Damp	315 - 8k/ Bypass	*8	0A
# Balance	D> 0E - D>74E - D 0<E	00 - 7F	12
Low Gain	-12 - 0 - +12	34 - 4C	13
Hi Gain	-12 - 0 - +12	34 - 4C	14
Level	0 - 127	00 - 7F	16
22 : Mod Delay			01 51
Dly Tm L	0 - 40m - 500m	*4	03
Dly Tm R	0 - 220m - 500m	*4	04
Feedback	-98% - +48% - +98%	0F - 71	05
Fb Mode	Norm/ Cross	00/01	06
+ Mod Rate	0.05 - 0.65 - 10.0	*6	07
Mod Depth	0 - 21 - 127	00 - 7F	08
Mod Phase	0 - 180	00 - 5A	09
HF Damp	315 - 8k/ Bypass	*8	0A
# Balance	D> 0E - D>61E - D 0<E	00 - 7F	12
Low Gain	-12 - 0 - +12	34 - 4C	13
Hi Gain	-12 - 0 - +12	34 - 4C	14
Level	0 - 127	00 - 7F	16
23 : 3 Tap Delay			01 52
Dly Tm C	200m - 300m - 990m/1sec*2		03
Dly Tm L	200m - 200m - 990m/1sec*2		04
Dly Tm R	200m - 235m - 990m/1sec*2		05
+ Feedback	-98% - +32% - +98%	0F - 71	06
Dly Lev C	0 - 127	00 - 7F	07
Dly Lev L	0 - 127	00 - 7F	08
Dly Lev R	0 - 127	00 - 7F	09
HF Damp	315 - 8k/ Bypass	*8	0A
# Balance	D> 0E - D>74E - D 0<E	00 - 7F	12
Low Gain	-12 - 0 - +12	34 - 4C	13
Hi Gain	-12 - 0 - +12	34 - 4C	14
Level	0 - 127	00 - 7F	16
24 : 4 Tap Delay			01 53
Dly Tm 1	200m - 500m - 990m/1sec*2		03
Dly Tm 2	200m - 300m - 990m/1sec*2		04
Dly Tm 3	200m - 400m - 990m/1sec*2		05
Dly Tm 4	200m - 200m - 990m/1sec*2		06
Dly Lev 1	0 - 127	00 - 7F	07
Dly Lev 2	0 - 127	00 - 7F	08
Dly Lev 3	0 - 127	00 - 7F	09
Dly Lev 4	0 - 127	00 - 7F	0A
+ Feedback	-98% - +32% - +98%	0F - 71	0B
HF Damp	315 - 8k/ Bypass	*8	0C

Parameter	Value (Dec.)	Value (Hex.) min - max	MSB/LSB(H)
# Balance	D> 0E - D>74E - D 0<E	00 - 7F	12
Low Gain	-12 - 0 - +12	34 - 4C	13
Hi Gain	-12 - 0 - +12	34 - 4C	14
Level	0 - 127	00 - 7F	16
25 : Tm Ctrl Delay			01 54
+ Dly Time	200m - 500m - 990m/1sec*3		03
Accel	0 - 10 - 15	*14	04
# Feedback	-98% - +32% - +98%	0F - 71	05
HF Damp	315 - 8k/ Bypass	*8	06
EFX Pan	L63 - 0 - R63	00 - 7F	07
Balance	D> 0E - D>74E - D 0<E	00 - 7F	12
Low Gain	-12 - 0 - +12	34 - 4C	13
Hi Gain	-12 - 0 - +12	34 - 4C	14
Level	0 - 127	00 - 7F	16
26 : Reverb			01 55
Type	Room1/2/ Stage1/2 /Hall1/2	00/01/02/03/04/05	03
Pre Dly	0 - 74m - 100m	*1	04
+ Time	0 - 120 - 127	00 - 7F	05
HF Damp	315 - 6.3k - 8k/Bypass	*8	06
# Balance	D> 0E - D=E - D 0<E	00 - 7F	12
Low Gain	-12 - 0 - +12	34 - 4C	13
Hi Gain	-12 - 0 - +12	34 - 4C	14
Level	0 - 127	00 - 7F	16
27 : Gate Reverb			01 56
Type	Norm /Reverse/Sweep1/2	00/01/02/03	03
Pre Dly	0 - 0.5m - 100m	*1	04
Gate Time	0 - 65m - 500m	00 - 63	05
+ Balance	D> 0E - D>65E - D 0<E	00 - 7F	12
Low Gain	-12 - 0 - +12	34 - 4C	13
Hi Gain	-12 - -3 - +12	34 - 4C	14
# Level	0 - 112 - 127	00 - 7F	16
28 : 3D Delay			01 57
Dly Tm C	0m - 300m - 500m	*4	03
Dly Tm L	0m - 200m - 500m	*4	04
Dly Tm R	0m - 240m - 500m	*4	05
+ Feedback	-98% - +32% - +98%	0F - 71	06
Dly Lev C	0 - 40 - 127	00 - 7F	07
Dly Lev L	0 - 64 - 127	00 - 7F	08
Dly Lev R	0 - 64 - 127	00 - 7F	09
HF Damp	315 - 8k/ Bypass	*8	0A
Out	Speaker /Phones	00/01	11
# Balance	D> 0E - D>74E - D 0<E	00 - 7F	12
Low Gain	-12 - 0 - +12	34 - 4C	13
Hi Gain	-12 - 0 - +12	34 - 4C	14
Level	0 - 127	00 - 7F	16
○ Effects that modify the pitch (pitch/shift type)			
29 : 2 Pitch Shifter			01 60
+ Coarse 1	-24 - +7 - +12	28 - 4C	03
Fine 1	-100 - -4 - +100	0E - 72	04
Pre Dly 1	0 - 100m	*1	05
EFX Pan 1	L63 - 0 - R63	00 - 7F	06
# Coarse 2	-24 - -5 - +12	28 - 4C	07
Fine 2	-100 - +4 - +100	0E - 72	08
Pre Dly 2	0 - 100m	*1	09
EFX Pan 2	L63 - 0 - R63	00 - 7F	0A
Shift Mode	1 - 3 - 5	00 - 04	0B
L.Bal	A> 0B - A=B - A 0<B	00 - 7F	0C
Balance	D> 0E - D>74E - D 0<E	00 - 7F	12
Low Gain	-12 - 0 - +12	34 - 4C	13
Hi Gain	-12 - 0 - +12	34 - 4C	14
Level	0 - 95 - 127	00 - 7F	16
+: Effect control 1 can be used to modify the value (p.92)			
#: Effect control 2 can be used to modify the value (p.92)			
MSB/LSB: Indicates the ** portion of the following exclusive messages. (p.196) (hexadecimal notation)			
For Effect Type (data section)			
F0 41 dev 42 12 40 03 00 *** sum F7			
For Effect Parameters (LSB part of address)			
F0 41 dev 42 12 40 03 ** data sum F7			
(dev: device ID, sum: checksum)			
Parameter	Value (Dec.)	Value (Hex.) min - max	MSB/LSB(H)
30 : Fb P.Shifter			01 61
+ P.Coarse	-24 - +7 - +12	28 - 4C	03
P.Fine	-100 - 0 - +100	0E - 72	04
# Feedback	-98% - +40% - +98%	0F - 71	05
Pre Dly	0 - 45m - 100m	*1	06
Mode	1 - 3 - 5	00 - 04	07
EFX Pan	L63 - 0 - R63	00 - 7F	08
Balance	D> 0E - D=E - D 0<E	00 - 7F	12
Low Gain	-12 - 0 - +12	34 - 4C	13
Hi Gain	-12 - -6 - +12	34 - 4C	14
Level	0 - 127	00 - 7F	16
○ Others			
31 : 3D Auto			01 70
Azimuth	180/L168 - 0 - R168	*13	03
+ Speed	0.05 - 1.30 - 10.0	*6	04
Clockwise	-/+	00/01	05
# Turn	Off/On	00/01	06
Out	Speaker /Phones	00/01	11
Level	0 - 127	00 - 7F	16
32 : 3D Manual			01 71
+ Azimuth	180/L168 - 0 - R168	*13	03
Out	Speaker /Phones	00/01	11
# Level	0 - 127	00 - 7F	16
33 : Lo-Fi 1			01 72
Pre Filter	1 - 2 - 6	00 - 05	03
Lo-Fi Type	1 - 6 - 9	00 - 08	04
Post Filter	1 - 2 - 6	00 - 05	05
+ Balance	D> 0E - D 0<E	00 - 7F	12
Low Gain	-12 - 0 - +12	34 - 4C	13
Hi Gain	-12 - 0 - +12	34 - 4C	14
# Pan	L63 - 0 - R63	00 - 7F	15
Level	0 - 127	00 - 7F	16
34 : Lo-Fi 2			01 73
Lo-Fi Type	1 - 2 - 6	00 - 05	03
Fil Type	Off/ LPF /HPF	00/01/02	04
Cutoff	250 - 630 - 8k	*9	05
+ R.Detune	0 - 127	00 - 7F	06
R.Nz Lev	0 - 64 - 127	00 - 7F	07
W/P Sel	White/Pink	00/01	08
W/P LPF	250 - 6.3k/ Bypass	*11	09
W/P Level	0 - 127	00 - 7F	0A
Disc Type	LP /EP/SP/RND	00/01/02/03	0B
Disc LPF	250 - 6.3k/ Bypass	*11	0C
Disc Nz Lev	0 - 127	00 - 7F	0D
Hum Type	50Hz /60Hz	00/01	0E
Hum LPF	250 - 6.3k/ Bypass	*11	0F
Hum Level	0 - 127	00 - 7F	10
M/S	Mono /Stereo	00 - 01	11
# Balance	D> 0E - D 0<E	00 - 7F	12
Low Gain	-12 - 0 - +12	34 - 4C	13
Hi Gain	-12 - 0 - +12	34 - 4C	14
Pan(Mono)	L63 - 0 - R63	00 - 7F	15
Level	0 - 127	00 - 7F	16

The correspondence between setting values and hexadecimal values for items in the Value column indicated with "" is shown in the "Effect Data Table" (p. 183).

*1	Pre Delay Time	*8	HF Damp
*2	Delay Time 1	*9	Cutoff Freq
*3	Delay Time 2	*10	EQ Freq
*4	Delay Time 3	*11	LPF
*5	Delay Time 4	*12	Manual
*6	Rate 1	*13	Azimuth
*7	Rate 2	*14	Accel

○ Effects that connect two types of effect in series (series 2)

Parameter	Value (Dec.)	Value (Hex.) min - max	MSB/LSB(H)
35 : OD → Chorus 02 00			
OD Drive	0 - 48 - 127	00 - 7F	03
+ OD Pan	L63 - 0 - R63	00 - 7F	04
OD Amp	Small/ BitIn /2-Stk/3-Stk	00/01/02/03	05
OD Amp Sw	Off/On	00/01	06
Cho Dly	0 - 1.0m - 100m	*1	08
Cho Rate	0.05 - 0.45 - 10.0	*6	09
Cho Depth	0 - 72 - 127	00 - 7F	0A
# Cho Bal	D> 0E - D=E - D 0<E	00 - 7F	0C
Low Gain	-12 - 0 - +12	34 - 4C	13
Hi Gain	-12 - 0 - +12	34 - 4C	14
Level	0 - 80 - 127	00 - 7F	16
36 : OD → Flanger 02 01			
OD Drive	0 - 48 - 127	00 - 7F	03
+ OD Pan	L63 - 0 - R63	00 - 7F	04
OD Amp	Small/ BitIn /2-Stk/3-Stk	00/01/02/03	05
OD Amp Sw	Off/On	00/01	06
FL Dly	0 - 1.6m - 100m	*1	08
FL Rate	0.05 - 0.60 - 10.0	*6	09
FL Depth	0 - 40 - 127	00 - 7F	0A
FL Fb	-98% - +80% - +98%	0F - 71	0B
# FL Bal	D> 0E - D>49E - D 0<E	00 - 7F	0C
Low Gain	-12 - 0 - +12	34 - 4C	13
Hi Gain	-12 - 0 - +12	34 - 4C	14
Level	0 - 80 - 127	00 - 7F	16
37 : OD → Delay 02 02			
OD Drive	0 - 48 - 127	00 - 7F	03
+ OD Pan	L63 - 0 - R63	00 - 7F	04
OD Amp	Small/ BitIn /2-Stk/3-Stk	00/01/02/03	05
OD Amp Sw	Off/On	00/01	06
Dly Time	0 - 250m - 500m	*4	08
Dly Fb	-98% - +32% - +98%	0F - 71	09
Dly HF	315 - 8k/ Bypass	*8	0A
# Dly Bal	D> 0E - D>74E - D 0<E	00 - 7F	0C
Low Gain	-12 - 0 - +12	34 - 4C	13
Hi Gain	-12 - 0 - +12	34 - 4C	14
Level	0 - 80 - 127	00 - 7F	16
38 : DS → Chorus 02 03			
DS Drive	0 - 48 - 127	00 - 7F	03
+ DS Pan	L63 - 0 - R63	00 - 7F	04
DS Amp	Small/ BitIn /2-Stk/3-Stk	00/01/02/03	05
DS Amp Sw	Off/On	00/01	06
Cho Dly	0 - 1.0m - 100m	*1	08
Cho Rate	0.05 - 0.45 - 10.0	*6	09
Cho Depth	0 - 72 - 127	00 - 7F	0A
# Cho Bal	D> 0E - D=E - D 0<E	00 - 7F	0C
Low Gain	-12 - 0 - +12	34 - 4C	13
Hi Gain	-12 - 0 - +12	34 - 4C	14
Level	0 - 72 - 127	00 - 7F	16
39 : DS → Flanger 02 04			
DS Drive	0 - 48 - 127	00 - 7F	03
+ DS Pan	L63 - 0 - R63	00 - 7F	04
DS Amp	Small/ BitIn /2-Stk/3-Stk	00/01/02/03	05
DS Amp Sw	Off/On	00/01	06
FL Dly	0 - 1.1m - 100m	*1	08
FL Rate	0.05 - 0.60 - 10.0	*6	09
FL Depth	0 - 24 - 127	00 - 7F	0A
FL Fb	-98% - +80% - +98%	0F - 71	0B
# FL Bal	D> 0E - D>49E - D 0<E	00 - 7F	0C
Low Gain	-12 - 0 - +12	34 - 4C	13
Hi Gain	-12 - 0 - +12	34 - 4C	14
Level	0 - 72 - 127	00 - 7F	16

Parameter	Value (Dec.)	Value (Hex.) min - max	MSB/LSB(H)
40 : DS → Delay 02 05			
DS Drive	0 - 48 - 127	00 - 7F	03
+ DS Pan	L63 - 0 - R63	00 - 7F	04
DS Amp	Small/ BitIn /2-Stk/3-Stk	00/01/02/03	05
DS Amp Sw	Off/On	00/01	06
Dly Time	0 - 250m - 500m	*4	08
Dly Fb	-98% - +32% - +98%	0F - 71	09
Dly HF	315 - 8k/ Bypass	*8	0A
# Dly Bal	D> 0E - D>74E - D 0<E	00 - 7F	0C
Low Gain	-12 - 0 - +12	34 - 4C	13
Hi Gain	-12 - 0 - +12	34 - 4C	14
Level	0 - 72 - 127	00 - 7F	16
41 : EH → Chorus 02 06			
+ EH Sens	0 - 64 - 127	00 - 7F	03
EH Mix	0 - 127	00 - 7F	04
Cho Dly	0 - 14m - 100m	*1	08
Cho Rate	0.05 - 0.45 - 10.0	*6	09
Cho Depth	0 - 101 - 127	00 - 7F	0A
# Cho Bal	D> 0E - D=E - D 0<E	00 - 7F	0C
Low Gain	-12 - 0 - +12	34 - 4C	13
Hi Gain	-12 - 0 - +12	34 - 4C	14
Level	0 - 80 - 127	00 - 7F	16
42 : EH → Flanger 02 07			
+ EH Sens	0 - 64 - 127	00 - 7F	03
EH Mix	0 - 127	00 - 7F	04
FL Dly	0 - 1.6m - 100m	*1	08
FL Rate	0.05 - 0.60 - 10.0	*6	09
FL Depth	0 - 24 - 127	00 - 7F	0A
FL Fb	-98% - +80% - +98%	0F - 71	0B
# FL Bal	D> 0E - D>74E - D 0<E	00 - 7F	0C
Low Gain	-12 - 0 - +12	34 - 4C	13
Hi Gain	-12 - 0 - +12	34 - 4C	14
Level	0 - 96 - 127	00 - 7F	16
43 : EH → Delay 02 08			
+ EH Sens	0 - 64 - 127	00 - 7F	03
EH Mix	0 - 127	00 - 7F	04
Dly Time	0 - 250m - 500m	*4	08
Dly Fb	-98% - +32% - +98%	0F - 71	09
Dly HF	315 - 8k/ Bypass	*8	0A
# Dly Bal	D> 0E - D>74E - D 0<E	00 - 7F	0C
Low Gain	-12 - 0 - +12	34 - 4C	13
Hi Gain	-12 - 0 - +12	34 - 4C	14
Level	0 - 88 - 127	00 - 7F	16
44 : Cho → Delay 02 09			
Cho Dly	0 - 1.0m - 100m	*1	03
Cho Rate	0.05 - 0.50 - 10.0	*6	04
Cho Depth	0 - 120 - 127	00 - 7F	05
+ Cho Bal	D> 0E - D=E - D 0<E	00 - 7F	07
Dly Time	0 - 250m - 500m	*4	08
Dly Fb	-98% - +32% - +98%	0F - 71	09
Dly HF	315 - 8k/ Bypass	*8	0A
# Dly Bal	D> 0E - D>74E - D 0<E	00 - 7F	0C
Low Gain	-12 - 0 - +12	34 - 4C	13
Hi Gain	-12 - 0 - +12	34 - 4C	14
Level	0 - 127	00 - 7F	16
45 : FL → Delay 02 0A			
FL Dly	0 - 1.6m - 100m	*1	03
FL Rate	0.05 - 0.60 - 10.0	*6	04
FL Depth	0 - 24 - 127	00 - 7F	05
+ FL Fb	-98% - +80% - +98%	0F - 71	06
FL Bal	D> 0E - D=E - D 0<E	00 - 7F	07
Dly Time	0 - 250m - 500m	*4	08
Dly Fb	-98% - +32% - +98%	0F - 71	09
Dly HF	315 - 8k/ Bypass	*8	0A
# Dly Bal	D> 0E - D>74E - D 0<E	00 - 7F	0C
Low Gain	-12 - 0 - +12	34 - 4C	13
Hi Gain	-12 - 0 - +12	34 - 4C	14
Level	0 - 127	00 - 7F	16

Parameter	Value (Dec.)	Value (Hex.) min - max	MSB/LSB(H)	Parameter	Value (Dec.)	Value (Hex.) min - max	MSB/LSB(H)
46 : Cho → Flanger				02 0B			
Cho Dly	0 - 1.0m - 100m	*1	03	OD Sel	Odrv/Dist	00/01	07
Cho Rate	0.05 - 0.45 - 10.0	*6	04	+ OD Drive	0 - 80 - 127	00 - 7F	08
Cho Depth	0 - 120 - 127	00 - 7F	05	OD Amp	Small/Bltn/ 2-Stk/3-Stk	00/01/02/03	09
+ Cho Bal	D> 0E - D=E - D 0<E	00 - 7F	07	OD Amp Sw	Off/On	00/01	0A
FL Dly	0 - 1.6m - 100m	*1	08	OD Sw	Off/On	00/01	0B
FL Rate	0.05 - 0.60 - 10.0	*6	09	EQ L Gain	-12 - +12	34 - 4C	0C
FL Depth	0 - 24 - 127	00 - 7F	0A	EQ M Fq	200 - 1k - 6.3k	*10	0D
FL Fb	-98% - +80% - +98%	0F - 71	0B	EQ M Q	0.5/1.0/ 2.0/4.0/9.0	00/01/02/03/04	0E
# FL Bal	D> 0E - D=E - D 0<E	00 - 7F	0C	EQ M Gain	-12 - +5 - +12	34 - 4C	0F
Low Gain	-12 - 0 - +12	34 - 4C	13	EQ H Gain	-12 - -10 - +12	34 - 4C	10
Hi Gain	-12 - 0 - +12	34 - 4C	14	CF Sel	Chorus/Flangr	00/01	11
Level	0 - 112 - 127	00 - 7F	16	CF Rate	0.05 - 0.45 - 6.40	*7	12
○ Effects that connect three or more types of effect in series (series 3 / series 4 / series 5)				00 - 7F			
47 : Rotary Multi				02 0C			
+ OD Drive	0 - 13 - 127	00 - 7F	03	50 : GTR Multi 3			04 02
OD Sw	Off/On	00/01	04	Wah Fil	LPF/BPF	00/01	03
EQ L Gain	-12 - 0 - +12	34 - 4C	05	+ Wah Man	0 - 60 - 127	00 - 7F	04
EQ M Fq	200 - 1.6k - 6.3k	*10	06	Wah Peak	0 - 10 - 127	00 - 7F	05
EQ M Q	0.5/1.0/2.0/4.0/9.0	00/01/02/03/04	07	Wah Sw	Off/On	00/01	06
EQ M Gain	-12 - 0 - +12	34 - 4C	08	OD Sel	Odrv/Dist	00/01	07
EQ H Gain	-12 - 0 - +12	34 - 4C	09	# OD Drive	0 - 80 - 127	00 - 7F	08
RT L Slow	0.05 - 0.35 - 10.0	*6	0A	OD Amp	Small/Bltn/ 2-Stk/3-Stk	00/01/02/03	09
RT L Fast	0.05 - 6.40 - 10.0	*6	0B	OD Amp Sw	Off/On	00/01	0A
RT Lo Accl	0 - 3 - 15	*14	0C	OD L Gain	-12 - 0 - +12	34 - 4C	0B
RT Lo Lev	0 - 127	00 - 7F	0D	OD H Gain	-12 - 0 - +12	34 - 4C	0C
RT H Slow	0.05 - 0.90 - 10.0	*6	0E	OD Sw	Off/On	00/01	0D
RT H Fast	0.05 - 7.50 - 10.0	*6	0F	CF Sel	Chorus/Flangr	00/01	0E
RT Hi Accl	0 - 11 - 15	*14	10	CF Rate	0.05 - 0.45 - 6.40	*7	0F
RT Hi Lev	0 - 64 - 127	00 - 7F	11	CF Depth	0 - 127	00 - 7F	10
RT Sept	0 - 96 - 127	00 - 7F	12	CF Fb	-98% - +50% - +98%	0F - 71	11
# RT Speed	Slow/Fast	00/7F	13	CF Mix	0 - 50 - 127	00 - 7F	12
Level	0 - 96 - 127	00 - 7F	16	Dly Time	0m - 160m - 635m	*5	13
48 : GTR Multi 1				04 00			
Cmp Atck	0 - 100 - 127	00 - 7F	03	Dly Fb	0 - 64 - 127	00 - 7F	14
Cmp Sus	0 - 80 - 127	00 - 7F	04	Dly Mix	0 - 30 - 127	00 - 7F	15
Cmp Level	0 - 100 - 127	00 - 7F	05	Level	0 - 88 - 127	00 - 7F	16
Cmp Sw	Off/On	00/01	06	51 : Clean Gt Multi1			
OD Sel	Odrv/Dist	00/01	07	Cmp Atck	0 - 50 - 127	00 - 7F	03
+ OD Drive	0 - 80 - 127	00 - 7F	08	Cmp Sus	0 - 127	00 - 7F	04
OD Amp	Small/Bltn/ 2-Stk/3-Stk	00/01/02/03	09	Cmp Level	0 - 75 - 127	00 - 7F	05
OD Amp Sw	Off/On	00/01	0A	Cmp Sw	Off/On	00/01	06
OD L Gain	-12 - +5 - +12	34 - 4C	0B	EQ L Gain	-12 - +12	34 - 4C	07
OD H Gain	-12 - +10 - +12	34 - 4C	0C	EQ M Fq	200 - 6.3k	*10	08
OD Sw	Off/On	00/01	0D	EQ M Q	0.5/1.0/ 2.0/4.0/9.0	00/01/02/03/04	09
CF Sel	Chorus/Flangr	00/01	0E	EQ M Gain	-12 - +5 - +12	34 - 4C	0A
CF Rate	0.05 - 0.45 - 6.40	*7	0F	EQ H Gain	-12 - +12	34 - 4C	0B
CF Depth	0 - 30 - 127	00 - 7F	10	CF Sel	Chorus/Flangr	00/01	0C
CF Fb	-98% - +76% - +98%	0F - 71	11	CF Rate	0.05 - 0.45 - 6.40	*7	0D
CF Mix	0 - 40 - 127	00 - 7F	12	CF Depth	0 - 40 - 127	00 - 7F	0E
Dly Time	0m - 300m - 635m	*5	13	CF Fb	-98% - +30% - +98%	0F - 71	0F
Dly Fb	0 - 34 - 127	00 - 7F	14	+ CF Mix	0 - 100 - 127	00 - 7F	10
# Dly Mix	0 - 15 - 127	00 - 7F	15	Dly Time	0m - 120m - 635m	*5	11
Level	0 - 110 - 127	00 - 7F	16	Dly Fb	0 - 40 - 127	00 - 7F	12
49 : GTR Multi 2				04 01			
Cmp Atck	0 - 70 - 127	00 - 7F	03	Dly HF	315 - 8k/ Bypass	*8	13
Cmp Sus	0 - 127	00 - 7F	04	# Dly Mix	0 - 30 - 127	00 - 7F	14
Cmp Level	0 - 90 - 127	00 - 7F	05	Level	0 - 95 - 127	00 - 7F	16
Cmp Sw	Off/On	00/01	06				

+: Effect control 1 can be used to modify the value (p.92)
#: Effect control 2 can be used to modify the value (p.92)
MSB/LSB: Indicates the ** portion of the following exclusive messages. (p.196) (hexadecimal notation)
For Effect Type (data section)
F0 41 dev 42 12 40 03 00 ** ** sum F7
For Effect Parameters (LSB part of address)
F0 41 dev 42 12 40 03 ** data sum F7
(dev: device ID, sum: checksum)

The correspondence between setting values and hexadecimal values for items in the Value column indicated with "*" is shown in the "Effect Data Table" (p. 183).

*1 Pre Delay Time	*8 HF Damp
*2 Delay Time 1	*9 Cutoff Freq
*3 Delay Time 2	*10 EQ Freq
*4 Delay Time 3	*11 LPF
*5 Delay Time 4	*12 Manual
*6 Rate 1	*13 Azimuth
*7 Rate 2	*14 Accl

Parameter	Value (Dec.)	Value (Hex.) min - max	MSB/LSB(H)	Parameter	Value (Dec.)	Value (Hex.) min - max	MSB/LSB(H)
52 : Clean Gt Multi2				04 04			
AW Filter	LPF/BPF	00/01	03	EQ M Gain	-12 - +5 - +12	34 - 4C	08
+ AW Man	0 - 55 - 127	00 - 7F	04	EQ H Gain	-12 - -3 - +12	34 - 4C	09
AW Peak	0 - 40 - 127	00 - 7F	05	PS Coarse	-24 - +7 - +12	28 - 4C	0A
AW Rate	0.05 - 1.50 - 6.40	*7	06	PS Fine	-100 - 0 - +100	0E - 72	0B
AW Depth	0 - 80 - 127	00 - 7F	07	PS Mode	1 - 5	00 - 04	0C
AW Sw	Off/On	00/01	08	PS Bal	D> 0E - D>60E - D 0<E	00 - 7F	0D
EQ L Gain	-12 - +12	34 - 4C	09	PH Man	100 - 620 - 8k	*12	0E
EQ M Fq	200 - 1.6k - 6.3k	*10	0A	PH Rate	0.05 - 0.45 - 6.40	*7	0F
EQ M Q	0.5/1.0/2.0/4.0/9.0	00/01/02/03/04	0B	PH Depth	0 - 90 - 127	00 - 7F	10
EQ M Gain	-12 - 0 - +12	34 - 4C	0C	PH Reso	0 - 80 - 127	00 - 7F	11
EQ H Gain	-12 - 0 - +12	34 - 4C	0D	PH Mix	0 - 75 - 127	00 - 7F	12
CF Sel	Chorus/Flangr	00/01	0E	Dly Time	0m - 100m - 635m	*5	13
CF Rate	0.05 - 0.45 - 6.40	*7	0F	Dly Fb	0 - 64 - 127	00 - 7F	14
CF Depth	0 - 20 - 127	00 - 7F	10	Dly Mix	0 - 40 - 127	00 - 7F	15
CF Fb	-98% - +76% - +98%	0F - 71	11	Level	0 - 96 - 127	00 - 7F	16
CF Mix	0 - 100 - 127	00 - 7F	12	○ Effects that connect two types of effect in parallel (parallel 2)			
Dly Time	0m - 30m - 635m	*5	13	56 : Cho / Delay			
Dly Fb	0 - 15 - 127	00 - 7F	14	11 00			
# Dly Mix	0 - 80 - 127	00 - 7F	15	Cho Dly	0 - 1.0m - 100m	*1	03
Level	0 - 76 - 127	00 - 7F	16	Cho Rate	0.05 - 0.45 - 10.0	*6	04
53 : Bass Multi				04 05			
Cmp Atck	0 - 72 - 127	00 - 7F	03	Cho Depth	0 - 120 - 127	00 - 7F	05
Cmp Sus	0 - 100 - 127	00 - 7F	04	+ Cho Bal	D> 0E - D=E - D 0<E	00 - 7F	07
Cmp Level	0 - 75 - 127	00 - 7F	05	Cho Pan	L63 - 0 - R63	00 - 7F	12
Cmp Sw	Off/On	00/01	06	Cho Level	0 - 127	00 - 7F	13
OD Sel	Odrv/Dist	00/01	07	Dly Time	0 - 250m - 500m	*4	08
+ OD Drive	0 - 48 - 127	00 - 7F	08	Dly Fb	-98% - +32% - +98%	0F - 71	09
OD Amp	Small/BitIn/2-Stk	00/01/02	09	Dly HF	315 - 8k/Bypass	*8	0A
OD Amp Sw	Off/On	00/01	0A	# Dly Bal	D> 0E - D>61E - D 0<E	00 - 7F	0C
OD Sw	Off/On	00/01	0B	Dly Pan	L63 - 0 - R63	00 - 7F	14
EQ L Gain	-12 - +2 - +12	34 - 4C	0C	Dly Level	0 - 127	00 - 7F	15
EQ M Fq	200 - 1.6k - 6.3k	*10	0D	Level	0 - 96 - 127	00 - 7F	16
EQ M Q	0.5/1.0/2.0/4.0/9.0	00/01/02/03/04	0E	57 : FL / Delay			
EQ M Gain	-12 - +4 - +12	34 - 4C	0F	11 01			
EQ H Gain	-12 - 0 - +12	34 - 4C	10	FL Dly	0 - 1.6m - 100m	*1	03
CF Sel	Chorus/Flangr	00/01	11	FL Rate	0.05 - 0.60 - 10.0	*6	04
CF Rate	0.05 - 0.30 - 6.40	*7	12	FL Depth	0 - 24 - 127	00 - 7F	05
CF Depth	0 - 20 - 127	00 - 7F	13	FL Fb	-98% - +80% - +98%	0F - 71	06
CF Fb	-98% - +76% - +98%	0F - 71	14	+ FL Bal	D> 0E - D=E - D 0<E	00 - 7F	07
# CF Mix	0 - 64 - 127	00 - 7F	15	FL Pan	L63 - 0 - R63	00 - 7F	12
Level	0 - 76 - 127	00 - 7F	16	FL Level	0 - 127	00 - 7F	13
54 : Rhodes Multi				04 06			
EH Sens	0 - 64 - 127	00 - 7F	03	Dly Time	0 - 250m - 500m	*4	08
EH Mix	0 - 64 - 127	00 - 7F	04	Dly Fb	-98% - +32% - +98%	0F - 71	09
PH Man	100 - 620 - 8k	*12	05	Dly HF	315 - 8k/Bypass	*8	0A
PH Rate	0.05 - 0.85 - 6.40	*7	06	# Dly Bal	D> 0E - D>74E - D 0<E	00 - 7F	0C
PH Depth	0 - 32 - 127	00 - 7F	07	Dly Pan	L63 - 0 - R63	00 - 7F	14
PH Reso	0 - 16 - 127	00 - 7F	08	Dly Level	0 - 127	00 - 7F	15
PH Mix	0 - 64 - 127	00 - 7F	09	Level	0 - 96 - 127	00 - 7F	16
CF Sel	Chorus/Flangr	00/01	0A	58 : Cho / Flanger			
CF LPF	250 - 6.3k/Bypass	*11	0B	11 02			
CF Dly	0 - 1.0m - 100m	*1	0C	Cho Dly	0 - 1.6m - 100m	*1	03
CF Rate	0.05 - 0.45 - 6.40	*7	0D	Cho Rate	0.05 - 0.45 - 10.0	*6	04
CF Depth	0 - 64 - 127	00 - 7F	0E	Cho Depth	0 - 120 - 127	00 - 7F	05
CF Fb	-98% - +80% - +98%	0F - 71	0F	+ Cho Bal	D> 0E - D=E - D 0<E	00 - 7F	07
CF Mix	0 - 127	00 - 7F	10	Cho Pan	L63 - 0 - R63	00 - 7F	12
TP Sel	Trem/Pan	00/01	11	Cho Level	0 - 127	00 - 7F	13
TP Mod WV	Tri/Sqr/Sin/Saw1/Saw2	00/01/02/03/04	12	FL Dly	0 - 1.6m - 100m	*1	08
+ TP Mod RT	0.05 - 3.05 - 6.40	*7	13	FL Rate	0.05 - 0.60 - 10.0	*6	09
# TP Mod Dep	0 - 64 - 127	00 - 7F	14	FL Depth	0 - 24 - 127	00 - 7F	0A
TP Sw	Off/On	00/01	15	FL Fb	-98% - +80% - +98%	0F - 71	0B
Level	0 - 127	00 - 7F	16	# FL Bal	D> 0E - D=E - D 0<E	00 - 7F	0C
55 : Keyboard Multi				05 00			
+ RM Mod Freq	0 - 50 - 127	00 - 7F	03	FL Pan	L63 - 0 - R63	00 - 7F	14
# RM Bal	D> 0E - D>30E - D 0<E	00 - 7F	04	FL Level	0 - 127	00 - 7F	15
EQ L Gain	-12 - +3 - +12	34 - 4C	05	Level	0 - 88 - 127	00 - 7F	16
EQ M Fq	200 - 6.3k	*10	06	59 : OD1 / OD2			
EQ M Q	0.5/1.0/2.0/4.0/9.0	00/01/02/03/04	07	11 03			
				OD1 Sel	Odrv/Dist	00/01	03
				+ OD1 Drive	0 - 48 - 127	00 - 7F	04
				OD1 Amp	Small/BitIn/2-Stk/3-Stk	00/01/02/03	05
				OD1 Amp Sw	Off/On	00/01	06
				OD1 Pan	L63 - 0 - R63	00 - 7F	12
				OD1 Level	0 - 96 - 127	00 - 7F	13
				OD2 Sel	Odrv/Dist	00/01	08

Parameter	Value (Dec.)	Value (Hex.) min - max	MSB/LSB(H)	Parameter	Value (Dec.)	Value (Hex.) min - max	MSB/LSB(H)
# OD2 Drive	0 - 76 - 127	00 - 7F	09	63 : PH / Rotary			11 07
OD2 Amp	Small/ BitIn /2-Stk/3-Stk	00/01/02/03	0A	PH Man	100 - 620 - 8k	*12	03
OD2 Amp Sw	Off/ On	00/01	0B	+ PH Rate	0.05 - 0.85 - 10.0	*6	04
OD2 Pan	L63 - 0 - R63	00 - 7F	14	PH Depth	0 - 64 - 127	00 - 7F	05
OD2 Level	0 - 84 - 127	00 - 7F	15	PH Reso	0 - 16 - 127	00 - 7F	06
Level	0 - 127	00 - 7F	16	PH Mix	0 - 127	00 - 7F	07
60 : OD / Rotary			11 04	PH Pan	L63 - 0 - R63	00 - 7F	12
OD Sel	Odrv /Dist	00/01	03	PH Level	0 - 127	00 - 7F	13
+ OD Drive	0 - 48 - 127	00 - 7F	04	RT L Slow	0.05 - 0.35 - 10.0	*6	08
OD Amp	Small/ BitIn /2-Stk/3-Stk	00/01/02/03	05	RT L Fast	0.05 - 6.40 - 10.0	*6	09
OD Amp Sw	Off/ On	00/01	06	RT Lo Accl	0 - 3 - 15	*14	0A
OD Pan	L63 - 0 - R63	00 - 7F	12	RT Lo Lev	0 - 127	00 - 7F	0B
OD Level	0 - 96 - 127	00 - 7F	13	RT H Slow	0.05 - 0.90 - 10.0	*6	0C
RT L Slow	0.05 - 0.35 - 10.0	*6	08	RT H Fast	0.05 - 7.50 - 10.0	*6	0D
RT L Fast	0.05 - 6.40 - 10.0	*6	09	RT Hi Accl	0 - 11 - 15	*14	0E
RT Lo Accl	0 - 3 - 15	*14	0A	RT Hi Lev	0 - 64 - 127	00 - 7F	0F
RT Lo Lev	0 - 127	00 - 7F	0B	RT Sept	0 - 96 - 127	00 - 7F	10
RT H Slow	0.05 - 0.90 - 10.0	*6	0C	# RT Speed	Slow /Fast	00/7F	11
RT H Fast	0.05 - 7.50 - 10.0	*6	0D	RT Pan	L63 - 0 - R63	00 - 7F	14
RT Hi Accl	0 - 11 - 15	*14	0E	RT Level	0 - 127	00 - 7F	15
RT Hi Lev	0 - 64 - 127	00 - 7F	0F	Level	0 - 127	00 - 7F	16
RT Sept	0 - 96 - 127	00 - 7F	10	64 : PH / AutoWah			11 08
# RT Speed	Slow /Fast	00/7F	11	PH Man	100 - 620 - 8k	*12	03
RT Pan	L63 - 0 - R63	00 - 7F	14	+ PH Rate	0.05 - 0.85 - 10.0	*6	04
RT Level	0 - 127	00 - 7F	15	PH Depth	0 - 64 - 127	00 - 7F	05
Level	0 - 127	00 - 7F	16	PH Reso	0 - 16 - 127	00 - 7F	06
61 : OD / Phaser			11 05	PH Mix	0 - 127	00 - 7F	07
OD Sel	Odrv /Dist	00/01	03	PH Pan	L63 - 0 - R63	00 - 7F	12
+ OD Drive	0 - 48 - 127	00 - 7F	04	PH Level	0 - 127	00 - 7F	13
OD Amp	Small/ BitIn /2-Stk/3-Stk	00/01/02/03	05	AW Filter	LPF/ BPF	00/01	08
OD Amp Sw	Off/ On	00/01	06	AW Sens	0 - 127	00 - 7F	09
OD Pan	L63 - 0 - R63	00 - 7F	12	# AW Man	0 - 68 - 127	00 - 7F	0A
OD Level	0 - 96 - 127	00 - 7F	13	AW Peak	0 - 62 - 127	00 - 7F	0B
PH Man	100 - 620 - 8k	*12	08	AW Rate	0.05 - 2.05 - 10.0	*6	0C
# PH Rate	0.05 - 0.85 - 10.0	*6	09	AW Depth	0 - 72 - 127	00 - 7F	0D
PH Depth	0 - 64 - 127	00 - 7F	0A	AW Pol	Down/ Up	00/01	0E
PH Reso	0 - 16 - 127	00 - 7F	0B	AW Pan	L63 - 0 - R63	00 - 7F	14
PH Mix	0 - 127	00 - 7F	0C	AW Level	0 - 127	00 - 7F	15
PH Pan	L63 - 0 - R63	00 - 7F	14	Level	0 - 127	00 - 7F	16
PH Level	0 - 127	00 - 7F	15				
Level	0 - 127	00 - 7F	16	62 : OD / AutoWah			11 06
OD Sel	Odrv /Dist	00/01	03	OD Sel	Odrv /Dist	00/01	03
+ OD Drive	0 - 48 - 127	00 - 7F	04	+ OD Drive	0 - 48 - 127	00 - 7F	04
OD Amp	Small/ BitIn /2-Stk/3-Stk	00/01/002/03	05	OD Amp	Small/ BitIn /2-Stk/3-Stk	00/01/002/03	05
OD Amp Sw	Off/ On	00/01	06	OD Amp Sw	Off/ On	00/01	06
OD Pan	L63 - 0 - R63	00 - 7F	12	OD Pan	L63 - 0 - R63	00 - 7F	12
OD Level	0 - 96 - 127	00 - 7F	13	OD Level	0 - 96 - 127	00 - 7F	13
AW Filter	LPF/ BPF	00/01	08	AW Filter	LPF/ BPF	00/01	08
AW Sens	0 - 127	00 - 7F	09	AW Sens	0 - 127	00 - 7F	09
# AW Man	0 - 68 - 127	00 - 7F	0A	# AW Man	0 - 68 - 127	00 - 7F	0A
AW Peak	0 - 62 - 127	00 - 7F	0B	AW Peak	0 - 62 - 127	00 - 7F	0B
AW Rate	0.05 - 2.05 - 10.0	*6	0C	AW Rate	0.05 - 2.05 - 10.0	*6	0C
AW Depth	0 - 72 - 127	00 - 7F	0D	AW Depth	0 - 72 - 127	00 - 7F	0D
AW Pol	Down/ Up	00/01	0E	AW Pol	Down/ Up	00/01	0E
AW Pan	L63 - 0 - R63	00 - 7F	14	AW Pan	L63 - 0 - R63	00 - 7F	14
AW Level	0 - 127	00 - 7F	15	AW Level	0 - 127	00 - 7F	15
Level	0 - 127	00 - 7F	16	Level	0 - 127	00 - 7F	16

+: Effect control 1 can be used to modify the value (p.92)
#: Effect control 2 can be used to modify the value (p.92)
MSB/LSB: Indicates the ** portion of the following exclusive messages. (p.196) (hexadecimal notation)
For Effect Type (data section)
F0 41 dev 42 12 40 03 00 ** ** sum F7
For Effect Parameters (LSB part of address)
F0 41 dev 42 12 40 03 ** data sum F7
(dev: device ID, sum: checksum)

The correspondence between setting values and hexadecimal values for items in the Value column indicated with "*" is shown in the "Effect Data Table" (p. 183).

*1 Pre Delay Time	*8 HF Damp
*2 Delay Time 1	*9 Cutoff Freq
*3 Delay Time 2	*10 EQ Freq
*4 Delay Time 3	*11 LPF
*5 Delay Time 4	*12 Manual
*6 Rate 1	*13 Azimuth
*7 Rate 2	*14 Accl

■ Effect data table

	1	2	3	4	5	6	7	8	9	10	11	12	13	14
Value(H)	Pre Delay	Delay	Delay	Delay	Delay	Rate1	Rate2	HF Damp	Cutoff	EQ	LPF	Manual	Azimuth	Accl
	Time	Time 1	Time 2	Time 3	Time 4				Freq	Freq				
	(ms)	(ms)	(ms)	(ms)	(ms)	(Hz)	(Hz)	(Hz)	(Hz)	(Hz)	(Hz)	(Hz)	(deg)	
00	0.0	200	200	0.0	0	0.05	0.05	315	250	200	250	100	L180(=R180)	0
01	0.1	205	205	0.1	5	0.10	0.10	"	"	"	"	110	"	"
02	0.2	210	210	0.2	10	0.15	0.15	"	"	"	"	120	"	"
03	0.3	215	215	0.3	15	0.20	0.20	"	"	"	"	130	"	"
04	0.4	220	220	0.4	20	0.25	0.25	"	"	"	"	140	"	"
05	0.5	225	225	0.5	25	0.30	0.30	"	"	"	"	150	"	"
06	0.6	230	230	0.6	30	0.35	0.35	"	"	"	"	160	L168	"
07	0.7	235	235	0.7	35	0.40	0.40	"	"	"	"	170	"	"
08	0.8	240	240	0.8	40	0.45	0.45	400	315	250	315	180	"	1
09	0.9	245	245	0.9	45	0.50	0.50	"	"	"	"	190	"	"
0A	1.0	250	250	1.0	50	0.55	0.55	"	"	"	"	200	L156	"
0B	1.1	255	255	1.1	55	0.60	0.60	"	"	"	"	210	"	"
0C	1.2	260	260	1.2	60	0.65	0.65	"	"	"	"	220	"	"
0D	1.3	265	265	1.3	65	0.70	0.70	"	"	"	"	230	"	"
0E	1.4	270	270	1.4	70	0.75	0.75	"	"	"	"	240	L144	"
0F	1.5	275	275	1.5	75	0.80	0.80	"	"	"	"	250	"	"
10	1.6	280	280	1.6	80	0.85	0.85	500	400	315	400	260	"	2
11	1.7	285	285	1.7	85	0.90	0.90	"	"	"	"	270	"	"
12	1.8	290	290	1.8	90	0.95	0.95	"	"	"	"	280	L132	"
13	1.9	295	295	1.9	95	1.00	1.00	"	"	"	"	290	"	"
14	2.0	300	300	2.0	100	1.05	1.05	"	"	"	"	300	"	"
15	2.1	305	305	2.1	105	1.10	1.10	"	"	"	"	320	"	"
16	2.2	310	310	2.2	110	1.15	1.15	"	"	"	"	340	L120	"
17	2.3	315	315	2.3	115	1.20	1.20	"	"	"	"	360	"	"
18	2.4	320	320	2.4	120	1.25	1.25	630	500	400	500	380	"	3
19	2.5	325	325	2.5	125	1.30	1.30	"	"	"	"	400	"	"
1A	2.6	330	330	2.6	130	1.35	1.35	"	"	"	"	420	L108	"
1B	2.7	335	335	2.7	135	1.40	1.40	"	"	"	"	440	"	"
1C	2.8	340	340	2.8	140	1.45	1.45	"	"	"	"	460	"	"
1D	2.9	345	345	2.9	145	1.50	1.50	"	"	"	"	480	"	"
1E	3.0	350	350	3.0	150	1.55	1.55	"	"	"	"	500	L96	"
1F	3.1	355	355	3.1	155	1.60	1.60	"	"	"	"	520	"	"
20	3.2	360	360	3.2	160	1.65	1.65	800	630	500	630	540	"	4
21	3.3	365	365	3.3	165	1.70	1.70	"	"	"	"	560	"	"
22	3.4	370	370	3.4	170	1.75	1.75	"	"	"	"	580	L84	"
23	3.5	375	375	3.5	175	1.80	1.80	"	"	"	"	600	"	"
24	3.6	380	380	3.6	180	1.85	1.85	"	"	"	"	620	"	"
25	3.7	385	385	3.7	185	1.90	1.90	"	"	"	"	640	"	"
26	3.8	390	390	3.8	190	1.95	1.95	"	"	"	"	660	L72	"
27	3.9	395	395	3.9	195	2.00	2.00	"	"	"	"	680	"	"
28	4.0	400	400	4.0	200	2.05	2.05	1000	800	630	800	700	"	5
29	4.1	405	405	4.1	205	2.10	2.10	"	"	"	"	720	"	"
2A	4.2	410	410	4.2	210	2.15	2.15	"	"	"	"	740	L60	"
2B	4.3	415	415	4.3	215	2.20	2.20	"	"	"	"	760	"	"
2C	4.4	420	420	4.4	220	2.25	2.25	"	"	"	"	780	"	"
2D	4.5	425	425	4.5	225	2.30	2.30	"	"	"	"	800	"	"
2E	4.6	430	430	4.6	230	2.35	2.35	"	"	"	"	820	L48	"
2F	4.7	435	435	4.7	235	2.40	2.40	"	"	"	"	840	"	"
30	4.8	440	440	4.8	240	2.45	2.45	1250	1000	800	1000	860	"	6
31	4.9	445	445	4.9	245	2.50	2.50	"	"	"	"	880	"	"
32	5.0	450	450	5.0	250	2.55	2.55	"	"	"	"	900	L36	"
33	5.5	455	455	5.5	255	2.60	2.60	"	"	"	"	920	"	"
34	6.0	460	460	6.0	260	2.65	2.65	"	"	"	"	940	"	"
35	6.5	465	465	6.5	265	2.70	2.70	"	"	"	"	960	"	"
36	7.0	470	470	7.0	270	2.75	2.75	"	"	"	"	980	L24	"
37	7.5	475	475	7.5	275	2.80	2.80	"	"	"	"	1000	"	"
38	8.0	480	480	8.0	280	2.85	2.85	1600	1250	1000	1250	1100	"	7
39	8.5	485	485	8.5	285	2.90	2.90	"	"	"	"	1200	"	"
3A	9.0	490	490	9.0	290	2.95	2.95	"	"	"	"	1300	L12	"
3B	9.5	495	495	9.5	295	3.00	3.00	"	"	"	"	1400	"	"
3C	10	500	500	10	300	3.05	3.05	"	"	"	"	1500	"	"
3D	11	505	505	11	305	3.10	3.10	"	"	"	"	1600	"	"
3E	12	510	510	12	310	3.15	3.15	"	"	"	"	1700	0	"
3F	13	515	515	13	315	3.20	3.20	"	"	"	"	1800	"	"

	1	2	3	4	5	6	7	8	9	10	11	12	13	14	
Value(H)	Pre Delay	Delay	Delay	Delay	Delay	Rate1	Rate2	HF Damp	Cutoff	EQ		LPF	Manual	Azimuth	Accl
	Time	Time 1	Time 2	Time 3	Time 4					Freq	Freq				
	(ms)	(ms)	(ms)	(ms)	(ms)	(Hz)	(Hz)	(Hz)	(Hz)	(Hz)	(Hz)	(Hz)	(deg)		
40	14	520	520	14	320	3.25	3.25	2000	1600	1250	1600	1900	0	8	
41	15	525	525	15	325	3.30	3.30	"	"	"	"	2000	"	"	
42	16	530	530	16	330	3.35	3.35	"	"	"	"	2100	R12	"	
43	17	535	535	17	335	3.40	3.40	"	"	"	"	2200	"	"	
44	18	540	540	18	340	3.45	3.45	"	"	"	"	2300	"	"	
45	19	545	545	19	345	3.50	3.50	"	"	"	"	2400	"	"	
46	20	550	550	20	350	3.55	3.55	"	"	"	"	2500	R24	"	
47	21	560	555	21	355	3.60	3.60	"	"	"	"	2600	"	"	
48	22	570	560	22	360	3.65	3.65	2500	2000	1600	2000	2700	"	9	
49	23	580	565	23	365	3.70	3.70	"	"	"	"	2800	"	"	
4A	24	590	570	24	370	3.75	3.75	"	"	"	"	2900	R36	"	
4B	25	600	575	25	375	3.80	3.80	"	"	"	"	3000	"	"	
4C	26	610	580	26	380	3.85	3.85	"	"	"	"	3100	"	"	
4D	27	620	585	27	385	3.90	3.90	"	"	"	"	3200	"	"	
4E	28	630	590	28	390	3.95	3.95	"	"	"	"	3300	R48	"	
4F	29	640	595	29	395	4.00	4.00	"	"	"	"	3400	"	"	
50	30	650	600	30	400	4.05	4.05	3150	2500	2000	2500	3500	"	10	
51	31	660	610	31	405	4.10	4.10	"	"	"	"	3600	"	"	
52	32	670	620	32	410	4.15	4.15	"	"	"	"	3700	R60	"	
53	33	680	630	33	415	4.20	4.20	"	"	"	"	3800	"	"	
54	34	690	640	34	420	4.25	4.25	"	"	"	"	3900	"	"	
55	35	700	650	35	425	4.30	4.30	"	"	"	"	4000	"	"	
56	36	710	660	36	430	4.35	4.35	"	"	"	"	4100	R72	"	
57	37	720	670	37	435	4.40	4.40	"	"	"	"	4200	"	"	
58	38	730	680	38	440	4.45	4.45	4000	3150	2500	3150	4300	"	11	
59	39	740	690	39	445	4.50	4.50	"	"	"	"	4400	"	"	
5A	40	750	700	40	450	4.55	4.55	"	"	"	"	4500	R84	"	
5B	41	760	710	50	455	4.60	4.60	"	"	"	"	4600	"	"	
5C	42	770	720	60	460	4.65	4.65	"	"	"	"	4700	"	"	
5D	43	780	730	70	465	4.70	4.70	"	"	"	"	4800	"	"	
5E	44	790	740	80	470	4.75	4.75	"	"	"	"	4900	R96	"	
5F	45	800	750	90	475	4.80	4.80	"	"	"	"	5000	"	"	
60	46	810	760	100	480	4.85	4.85	5000	4000	3150	4000	5100	"	12	
61	47	820	770	110	485	4.90	4.90	"	"	"	"	5200	"	"	
62	48	830	780	120	490	4.95	4.95	"	"	"	"	5300	R108	"	
63	49	840	790	130	495	5.00	5.00	"	"	"	"	5400	"	"	
64	50	850	800	140	500	5.10	5.05	"	"	"	"	5500	"	"	
65	52	860	810	150	505	5.20	5.10	"	"	"	"	5600	"	"	
66	54	870	820	160	510	5.30	5.15	"	"	"	"	5700	R120	"	
67	56	880	830	170	515	5.40	5.20	"	"	"	"	5800	"	"	
68	58	890	840	180	520	5.50	5.25	6300	5000	4000	5000	5900	"	13	
69	60	900	850	190	525	5.60	5.30	"	"	"	"	6000	"	"	
6A	62	910	860	200	530	5.70	5.35	"	"	"	"	6100	R132	"	
6B	64	920	870	210	535	5.80	5.40	"	"	"	"	6200	"	"	
6C	66	930	880	220	540	5.90	5.45	"	"	"	"	6300	"	"	
6D	68	940	890	230	545	6.00	5.50	"	"	"	"	6400	"	"	
6E	70	950	900	240	550	6.10	5.55	"	"	"	"	6500	R144	"	
6F	72	960	910	250	555	6.20	5.60	"	"	"	"	6600	"	"	
70	74	970	920	260	560	6.30	5.65	8000	6300	5000	6300	6700	"	14	
71	76	980	930	270	565	6.40	5.70	"	"	"	"	6800	"	"	
72	78	990	940	280	570	6.50	5.75	"	"	"	"	6900	R156	"	
73	80	1000	950	290	575	6.60	5.80	"	"	"	"	7000	"	"	
74	82	--	960	300	580	6.70	5.85	"	"	"	"	7100	"	"	
75	84	--	970	320	585	6.80	5.90	"	"	"	"	7200	"	"	
76	86	--	980	340	590	6.90	5.95	"	"	"	"	7300	R168	"	
77	88	--	990	360	595	7.00	6.00	"	"	"	"	7400	"	"	
78	90	--	1000	380	600	7.50	6.05	Bypass	8000	6300	Bypass	7500	"	15	
79	92	--	1000	400	605	8.00	6.10	"	"	"	"	7600	"	"	
7A	94	--	1000	420	610	8.50	6.15	"	"	"	"	7700	R180(=L180)	"	
7B	96	--	1000	440	615	9.00	6.20	"	"	"	"	7800	"	"	
7C	98	--	1000	460	620	9.50	6.25	"	"	"	"	7900	"	"	
7D	100	--	1000	480	625	10.00	6.30	"	"	"	"	8000	"	"	
7E	100	--	1000	500	630	10.00	6.35	"	"	"	"	8000	"	"	
7F	100	--	1000	500	635	10.00	6.40	"	"	"	"	8000	"	"	

The following effect types are used in the table on the preceding page.

Pre Delay Time

10: Stereo Flanger
11: Step Flanger
16: Hexa Chorus
17: Tremolo Chorus
18: Stereo Chorus
19: Space-D
20: 3D Chorus
26: Reverb
27: Gate Reverb
29: 2 Pitch Shifter
30: Fb P.Shifter
35: OD → Chorus
36: OD → Flanger
38: DS → Chorus
39: DS → Flanger
41: EH → Chorus
42: EH → Flanger
44: Cho → Delay
45: FL → Delay
46: Cho → Flanger
54: Rhodes Multi
56: Cho / Delay
57: FL / Delay
58: Cho / Flanger

Delay Time1

23: 3 Tap Delay
24: 4 Tap Delay

Delay Time2

25: Tm Ctrl Delay

Delay Time3

21: Stereo Delay
22: Mod Delay
28: 3D Delay
37: OD → Delay
40: DS → Delay
43: EH → Delay
44: Cho → Delay
45: FL → Delay
56: Cho / Delay
57: FL / Delay

Delay Time4

48: GTR Multi 1
50: GTR Multi 3
51: Clean Gt Multi 1
52: Clean Gt Multi 2
55: Keyboard Multi

Rate1

7: Phaser
8: Auto Wah
9: Rotary
10: Stereo Flanger
11: Step Flanger
12: Tremolo
13: Auto Pan
16: Hexa Chorus
17: Tremolo Chorus
18: Stereo Chorus
19: Space-D
20: 3D Chorus
22: Mod Delay

35: OD → Chorus
36: OD → Flanger
38: DS → Chorus
39: DS → Flanger
41: EH → Chorus
42: EH → Flanger
44: Cho → Delay
45: FL → Delay
46: Cho → Flanger
47: Rotary Multi
56: Cho / Delay
57: FL / Delay
58: Cho / Flanger
60: OD / Rotary
61: OD / Phaser
62: OD / Auto Wah
63: PH / Rotary
64: PH / Auto Wah

Rate2

48: GTR Multi 1
49: GTR Multi 2
50: GTR Multi 3
51: Clean Gt Multi 1
52: Clean Gt Multi 2
53: Bass Multi
54: Rhodes Multi
55: Keyboard Multi

HF Damp

21: Stereo Delay
22: Mod Delay
23: 3 Tap Delay
24: 4 Tap Delay
25: Tm Ctrl Delay
26: Reverb
28: 3D Delay
37: OD → Delay
40: DS → Delay
43: EH → Delay
44: Cho → Delay
45: FL → Delay
51: Clean Gt Multi 1
56: Cho / Delay
57: FL / Delay

Cutoff Freq

10: Stereo Flanger
18: Stereo Chorus
34: Lo-Fi 2

LPF

34: Lo-Fi 2
54: Rhodes Multi

Manual

7: Phaser
54: Rhodes Multi
55: Keyboard Multi
61: OD / Phaser
63: PH / Rotary
64: PH / Auto Wah

Azimuth

31: 3D Auto
32: 3D Locate

■ Preset Patch list

No.	Patch Name	Map	PC/CC00	Instrument	Effect type
001	RB STRAT	[Native]	028/000	Clean Gt.	48:GTR Multi 1
002	MILD OD	[Native]	028/016	TC FrontPick	48:GTR Multi 1
003	WAH! PEDAL	[Native]	028/017	TC Rear Pick	50:GTR Multi 3
004	WARM OD	[Native]	028/016	TC FrontPick	49:GTR Multi 2
005	EC STRAT	[Native]	028/001	Clean Half	48:GTR Multi 1
006	BLUES OD	[Native]	028/019	TC Clean 2:	05:Overdrive
007	HEAVY & WILD	[Native]	028/017	TC Rear Pick	49:GTR Multi 2
008	FLANGER GTR	[Native]	028/019	TC Clean 2:	49:GTR Multi 2
009	SLOW GEAR	[Native]	028/019	TC Clean 2:	40:DS -> Delay
010	MID-BOOST	[Native]	028/017	TC Rear Pick	50:GTR Multi 3
011	POWER RHYTHM	[55]	029/000	"Muted Gt.	49:GTR Multi 2
012	HEAVY RHYTHM	[Native]	035/001	Picked Bass2	49:GTR Multi 2
013	NOISY RHYTHM	[Native]	028/003	Open Hard 2	59: OD1 / OD2
		[Native]	028/002	Open Hard 1	59: OD1 / OD2
014	CLEAN RHYTHM	[Native]	028/003	Open Hard 2	51:CleanGtMulti1
015	WAH RHYTHM	[Native]	028/003	Open Hard 2	52:CleanGtMulti2
016	T-WAH GUITAR	[Native]	028/003	Open Hard 2	08:Auto Wah
017	FUNK PHASE	[Native]	028/003	Open Hard 2	07:Phaser
018	MELLOW&CLEAN	[Native]	028/016	TC FrontPick	51:CleanGtMulti1
019	COOL ARP.	[Native]	028/001	Clean Half	51:CleanGtMulti1
020	SURF GUITAR	[Native]	029/002	TC Muted Gt.	51:CleanGtMulti1
021	JAZZ GUITAR	[Native]	027/000	Jazz Gt.	51:CleanGtMulti1
022	NYLON BOSSA	[Native]	025/032	Nylon Gt.2	26:Reverb
023	ENH. NYLON	[Native]	025/000	Nylon-str.Gt	43:EH -> Delay
024	ENH. STEEL	[Native]	026/032	Steel Gt.2	41:EH -> Chorus
025	COMP PK BASS	[Native]	035/000	Picked Bass	53:Bass Multi
026	DRIVE PK BS.	[Native]	035/000	Picked Bass	53:Bass Multi
027	JP FRETLESS	[Native]	036/001	Fretless Bs2	53:Bass Multi
028	HYPER BASS	[Native]	039/001	SynthBass101	62:OD / AutoWah
		[Native]	037/009	Unison Slap	62:OD / AutoWah
029	303 SAW BASS	[Native]	039/013	TB303 Saw Bs	07:Phaser
030	FAT S.BASS	[Native]	040/000	Synth Bass 2	07:Phaser
031	SYNC BASS	[Native]	040/024	Sync Bass	07:Phaser
032	HUMAN BASS	[Native]	039/009	TB303 Bass	04:Humanizer
033	PH RHODES	[Native]	005/000	E.Piano 1	07:Phaser
034	TREM RHODES	[Native]	005/000	E.Piano 1	17:Tremolo Chorus
035	TREM WURLY	[Native]	005/024	Wurlly	54:Rhodes Multi
036	TREM FM EP	[Native]	006/016	ST. FM EP	17:TremoloChorus
037	SC RHODES	[Native]	005/000	E.Piano 1	54:Rhodes Multi
038	SOFT E.PIANO	[88]	005/008	'St.Soft EP	22:Mod Delay
039	COMP PIANO	[Native]	003/000	Piano 3	14:Compressor
040	COMP CLAV.	[Native]	008/000	Clav.	51:CleanGtMulti1
041	THE E.ORGAN	[Native]	017/000	Organ 1	09:Rotary
042	TREM ORGAN	[Native]	017/008	Trem. Organ	09:Rotary
043	5TH ORGAN	[Native]	017/048	5th Organ	09:Rotary
044	PERC. ORGAN	[88]	018/000	'Organ 2	09:Rotary
045	OD-ROT ORGAN	[Native]	017/000	Organ 1	47:Rotary Multi
046	THEARTER ORG	[Native]	020/033	Theater Org.	26:Reverb
047	DIGI ORGAN	[Native]	017/028	VS Organ	22:Mod Delay
048	ORGAN BELL	[Native]	101/008	Org Bell	09:Rotary
049	CHO STRINGS	[Native]	049/016	St. Strings	18:Stereo Chorus
050	WIDE STRINGS	[Native]	049/002	ChamberStr:	28:3D Delay
051	WIDE SYN STR	[Native]	050/009	Warm Strings	20:3D Chorus
052	WARM STRINGS	[Native]	051/009	Syn.Strings4	22:Mod Delay
053	FAT STRINGS	[Native]	049/012	Strings+Horn	22:Mod Delay
054	SPIC WALTZ	[Native]	046/016	Solo Spic.	23:3 Tap Delay
055	WIDE CHOIR	[Native]	053/009	Melted Choir	28:3D Delay
056	DUAL CHOIR	[Native]	053/008	St.ChoirAahs	21:Stereo Delay
		[88]	053/032	'ChoirAahs 2	21:Stereo Delay
057	NYMAN BRASS	[Native]	062/000	Brass 1	03:Enhancer
		[Native]	066/016	AltoSax + Tp	---
058	SAX LIVE	[Native]	067/009	St.Tenor Sax	30:Fb P.Shifter
		[Native]	068/000	Baritone Sax	---
059	SFORZANDO	[Native]	062/010	Brass sfz	03:Enhancer
060	TS WIND	[Native]	091/003	Poly King	29:2PitchShifter
061	ANALOG BRS	[Native]	063/001	JUNO Brass	03:Enhancer
		[Native]	063/009	P5 Brass	03:Enhancer
062	OCT BRASS	[Native]	063/016	Oct SynBrass	03:Enhancer
		[Native]	063/002	Stack Brass	03:Enhancer
063	M.TROMBONE	[55]	058/000	"Trombone	02:Spectrum
064	DRIVE TENOR	[Native]	067/000	Tenor Sax	35:OD -> Chorus
065	PM SYN LEAD	[Native]	082/017	PM Lead	22:Mod Delay
066	MAD CHO LEAD	[Native]	084/008	Mad Lead	16:Hexa Chorus

No.	Patch Name	Map	PC/CC00	Instrument	Effect type
067	MG SAW LEAD	[Native]	082/031	MG Saw Lead	23:3 Tap Delay
068	OB SAW LEAD	[Native]	082/032	OB Saw Lead	23:3 Tap Delay
069	SINE LEAD	[Native]	081/009	Sine Lead	23:3 Tap Delay
070	BND WAH LEAD	[Native]	066/000	Alto Sax	50:GTR Multi 3
071	SUPER SAW	[Native]	082/000	Saw Wave	55:KeyboardMulti
072	SILKY LEAD	[Native]	017/032	70's E.Organ	55:KeyboardMulti
073	STEP SYNC	[Native]	085/017	Fat SyncLead	11:Step Flanger
074	PHASER HPF	[Native]	096/011	Bag Sweep	07:Phaser
075	PHASER STR	[Native]	052/008	Air Strings	07:Phaser
076	PROLOGUE	[Native]	098/003	Prologue 2	07:Phaser
077	MOD SWEEP	[Native]	096/011	Bag Sweep	22:Mod Delay
078	MOD HEAVEN	[Native]	092/002	SC Heaven	22:Mod Delay
079	RAVE SHIFT	[Native]	098/008	Rave	29:2PitchShifter
080	FB FAR OUT!	[Native]	031/009	Feedback Gt2	25:Tm Ctrl Delay
081	STEP BELL	[Native]	093/000	Bowed Glass	11:Step Flanger
082	STEP STRINGS	[Native]	052/002	JUNO Strings	11:Step Flanger
083	SEQ HORN PAD	[Native]	090/002	Horn Pad	11:Step Flanger
084	THE SOFT PAD	[88]	090/004	'Soft Pad	22:Mod Delay
085	RATTLE PAD	[Native]	097/004	Rattle Pad	22:Mod Delay
086	WARM VOX PAD	[Native]	095/001	Vox Pad	22:Mod Delay
087	JP8 SQR PAD	[Native]	093/002	JP8 Sqr Pad	19:Space D
088	OB SOFT PAD	[Native]	090/004	OB Soft Pad	19:Space D
089	PAN SEQUENCE	[Native]	103/008	Pan Sequence	23:3 Tap Delay
090	ASIAN DREAM	[Native]	108/001	Gu Zheng	24:4 Tap Delay
		[Native]	089/000	Fantasia	---
091	ER HU LEAD	[Native]	111/008	Er Hu	24:4 Tap Delay
092	ZITHER	[Native]	016/016	Zither 1	21:Stereo Delay
093	PSY. TABLA	[Native]	032/016	Ac.Gt.Harmnx	55:KeyboardMulti
094	SITAR DANCE	[Native]	105/003	Sitar 3	55:KeyboardMulti
095	SPIN BIWA	[Native]	121/013	Biwa Tremolo	31:3D Auto
096	ARABIC LEAD	[Native]	112/024	Mizmar	23:3 Tap Delay
097	3D BUBBLE	[Native]	123/005	Bubble	31:3D Auto
098	3D ROTARY	[Native]	017/000	Organ 1	31:3D Auto
099	3D DIDGERIDO	[Native]	110/008	Didgeridoo	31:3D Auto
100	3D BAG SWEEP	[Native]	096/011	Bag Sweep	20:3D Chorus
101	3D UFO.....	[Native]	102/014	UFO FX	20:3D Chorus
102	3D CHURCH	[Native]	015/008	Church Bell	20:3D Chorus
103	3D IMPCT HIT	[Native]	056/012	Shock Wave	28:3D Delay
104	3D EXCITE !!	[Native]	127/006	Applause 2	28:3D Delay
105	LO-FI AUH	[Native]	102/004	Auhbient	33:Lo-Fi 1
106	LO-FI TECHNO	[Native]	102/013	Alternative	33:Lo-Fi 1
107	LO-FI ORGAN	[Native]	017/024	Cheese Organ	33:Lo-Fi 1
108	LO-FI SQUARE	[Native]	093/002	JP8 Sqr Pad	33:Lo-Fi 1
109	LO-FI VOX	[Native]	086/008	Vox Lead	33:Lo-Fi 1
110	LO-FI JAZZ	[Native]	RHY/033	JAZZ SET	34:Lo-Fi 2
111	LO-FI DUO	[Native]	004/008	Honky-tonk 2	34:Lo-Fi 2
		[Native]	033/000	Acoustic Bs.	34:Lo-Fi 2
112	LO-FI GND NZ	[Native]	030/003	More Drive	34:Lo-Fi 2
113	LEAD & SEQ	[Native]	085/016	P5 Sync Lead	19:Space D
		[Native]	039/024	Arpeggio Bs	19:Space D
114	PIANO & BASS	[Native]	001/000	Piano 1	---
		[Native]	033/000	Acoustic Bs.	---
115	GTR & ORGAN	[Native]	017/000	Organ 1	60:OD / Rotary
		[Native]	028/016	TC FrontPick	60:OD / Rotary
116	VIOLIN&CELLO	[Native]	041/000	Violin :	43:EH -> Delay
		[Native]	043/000	Cello :	43:EH -> Delay
117	BRS. & FLUTE	[Native]	074/001	Flute 2 :	---
		[Native]	062/008	Brass 2	30:Fb P.Shifter
118	SYNTH SPLIT	[Native]	082/018	CS Saw Lead	---
		[Native]	063/001	JUNO Brass	---
119	PIANO & VIBE	[Native]	001/000	Piano 1	26:Reverb
		[Native]	012/000	Vibraphone	26:Reverb
120	JAZZ RHYTHM	[88]	033/000	'AcousticBs.	---
		[Native]	RHY/033	JAZZ SET	---
121	ACID PANNER	[Native]	085/009	Acid Guitar1	13:Auto Pan
122	LFO RAVE	[Native]	102/010	LFO RAVE	19:Space D
123	FLANGER NZ	[Native]	123/016	Pink Noise	10:StereoFlanger
124	1 KEY STROKE	[Native]	121/011	Chord Stroke	24:4 Tap Delay
125	INET LIVE:-)	[Native]	127/007	Small Club	34:Lo-Fi 2
126	DOUBLE HIT	[Native]	056/017	Techno Hit	---
		[Native]	056/016	Lo Fi Rave	33:Lo-Fi 1
127	SCRAPE SHIFT	[Native]	121/006	Pick Scrape	30:Fb P.Shifter
128	EPILOGUE	[Native]	055/016	VP330 Choir	30:Fb P.Shifter

This unit implements additional functionality and parameters over and above the SC-88, which itself was an expansion of the GS sound source format. These functions and parameters are marked by a [Pro] symbol. If MIDI messages marked by a [Pro] symbol are transmitted to another GS format sound source or to the SC-88, those messages may not be recognized. Also, functions and parameters which were added to the SC-88 over and above previous GS format sound sources are marked by an [88] symbol.

Section 1. Receive data

Channel Voice Messages

Note off

Status	2nd byte	3rd byte
8nH	kkH	vvH
9nH	kkH	00H

n = MIDI channel number : 0H-FH (ch.1-ch.16)
 kk = note number : 00H-7FH (0-127)
 vv = note off velocity : 00H-7FH (0-127)

* For Drum Parts, these messages are received when Rx.NOTE OFF = ON for each Instrument.

* The velocity values of Note Off messages are ignored.

Note on

Status	2nd byte	3rd byte
9nH	kkH	vvH

n = MIDI channel number : 0H-FH (ch.1-ch.16)
 kk = note number : 00H-7FH (0-127)
 vv = note on velocity : 01H-7FH (1-127)

* Not received when Rx.NOTE MESSAGE = OFF. (Initial value is ON)

* For Drum Parts, not received when Rx.NOTE ON = OFF for each Instrument.

Polyphonic Key Pressure

Status	2nd byte	3rd byte
AnH	kkH	vvH

n = MIDI channel number : 0H-FH (ch.1-ch.16)
 kk = note number : 00H-7FH (0-127)
 vv = key pressure : 00H-7FH (0-127)

* Not received when Rx.POLY PRESSURE (Paf) = OFF. (Initial value is ON)

* The resulting effect is determined by System Exclusive messages. With the initial settings, there will be no effect.

Control Change

* When Rx.CONTROL CHANGE = OFF, all control change messages except for Channel Mode messages will be ignored.

* The value specified by a Control Change message will not be reset even by a Program Change, etc.

Bank Select (Controller number 0, 32) [88]

Status	2nd byte	3rd byte
BnH	00H	mmH
BnH	20H	llH

n = MIDI channel number : 0H-FH (ch.1-ch.16)
 mm = Bank number MSB : 00H-7FH (GS Variation number 0 - 127), Initial Value = 00H
 ll = Bank number LSB : 00H - 03H (MAP), Initial Value = 00H

* Not received when Rx.BANK SELECT = OFF. "Rx.BANK SELECT" is set to OFF by "Turn General MIDI System On," and set to ON by "GS RESET." (Power-on default value is ON.)

* When Rx.BANK SELECT LSB = OFF, Bank number LSB will be handled as 00H regardless of the received value. However, when sending Bank Select messages, you have to send both the MSB (mmH) and LSB (llH, the value should be 00H) together.

* Bank Select processing will be suspended until a Program Change message is received.

* The GS format "Variation number" is the value of the Bank Select MSB (Controller number 0) expressed in decimal.

* This unit recognizes the Bank Select LSB (Controller number 32) as a flag for switching between the Native MAP, SC-88MAP and the SC-55MAP. With a Bank Select LSB of 00H, the map selected by the front panel SC-88MAP or SC-55MAP button will be selected. With a LSB of 01H, the SC-55MAP will be selected. With a LSB of 02H, the SC-88MAP will be selected.

With a LSB of 03H, the Native MAP will be selected.

* Some other GS devices do not recognize the Bank Select LSB (Controller number 32).

Modulation (Controller number 1)

Status	2nd byte	3rd byte
BnH	01H	vvH

n = MIDI channel number : 0H-FH (ch.1-ch.16)
 vv = Modulation depth : 00H-7FH (0-127)

* Not received when Rx.MODULATION = OFF. (Initial value is ON)

* The resulting effect is determined by System Exclusive messages. With the initial settings, this is Pitch Modulation Depth.

Portamento Time (Controller number 5)

Status	2nd byte	3rd byte
BnH	05H	vvH

n = MIDI channel number : 0H-FH (ch.1-ch.16)
 vv = Portamento Time : 00H-7FH (0-127), Initial value = 00H (0)

* This adjusts the rate of pitch change when Portamento is ON or when using the Portamento Control. A value of 0 results in the fastest change.

Data Entry (Controller number 6, 38)

Status	2nd byte	3rd byte
BnH	06H	mmH
BnH	26H	llH

n = MIDI channel number : 0H-FH (ch.1-ch.16)
 mm, ll = the value of the parameter specified by RPN/NRPN
 mm = MSB, ll = LSB

Volume (Controller number 7)

Status	2nd byte	3rd byte
BnH	07H	vvH

n = MIDI channel number : 0H-FH (ch.1-ch.16)
 vv = Volume : 00H-7FH (0-127), Initial Value = 64H (100)

* Volume messages are used to adjust the volume balance of each Part.

* Not received when Rx.VOLUME = OFF. (Initial value is ON)

Pan (Controller number 10)

Status	2nd byte	3rd byte
BnH	0AH	vvH

n = MIDI channel number : 0H-FH (ch.1-ch.16)
 vv = pan : 00H-40H-7FH (Left-Center-Right), Initial Value = 40H (Center)

* For Rhythm Parts, this is a relative adjustment of each Instrument's pan setting.

* Not received when Rx.PANPOT = OFF. (Initial value is ON)

Expression (Controller number 11)

Status	2nd byte	3rd byte
BnH	0BH	vvH

n = MIDI channel number : 0H-FH (ch.1-ch.16)
 vv = Expression : 00H-7FH (0-127), Initial Value = 7FH (127)

* This adjusts the volume of a Part. It can be used independently from Volume messages. Expression messages are used for musical expression within a performance; e.g., expression pedal movements, crescendo and decrescendo.

* Not received when Rx.EXPRESSION = OFF. (Initial value is ON)

Hold 1 (Controller number 64)

Status	2nd byte	3rd byte
BnH	40H	vvH

n = MIDI channel number : 0H-FH (ch.1-ch.16)
 vv = Control value : 00H-7FH (0-127)

* Not received when Rx.HOLD1 = OFF. (Initial value is ON)

Portamento (Controller number 65)

Status	2nd byte	3rd byte
BnH	41H	vvH

n = MIDI channel number : 0H-FH (ch.1-ch.16)
 vv = Control value : 00H-7FH (0-127) 0-63 = OFF, 64-127 = ON

* Not received when Rx.PORTAMENTO = OFF. (Initial value is ON)

○ **Sostenuto (Controller number 66)**

Status 2nd byte 3rd byte
BnH 42H vvH

n = MIDI channel number : 0H-FH (ch.1-ch.16)
vv = Control value : 00H-7FH (0-127) 0-63 = OFF, 64-127 = ON

* Not received when Rx.SOSTENUTO = OFF. (Initial value is ON)

○ **Soft (Controller number 67)**

Status 2nd byte 3rd byte
BnH 43H vvH

n = MIDI channel number : 0H-FH (ch.1-ch.16)
vv = Control value : 00H-7FH (0-127) 0-63 = OFF, 64-127 = ON

* Not received when Rx.SOFT = OFF. (Initial value is ON)

○ **Portamento control (Controller number 84)**

Status 2nd byte 3rd byte
BnH 54H kkH

n = MIDI channel number : 0H-FH (ch.1-ch.16)
kk = source note number : 00H-7FH (0-127)

* A Note-on received immediately after a Portamento Control message will change continuously in pitch, starting from the pitch of the Source Note Number.

* If a voice is already sounding for a note number identical to the Source Note Number, this voice will continue sounding (i.e., legato) and will, when the next Note-on is received, smoothly change to the pitch of that Note-on.

* The rate of the pitch change caused by Portamento Control is determined by the Portamento Time value.

Example 1.

On MIDI	Description	Result
90 3C 40	Note on C4	C4 on
B0 54 3C	Portamento Control from C4	no change
90 40 40	Note on E4	glide from C4 to E4
80 3C 40	Note off C4	no change
80 40 40	Note off E4	E4 off

Example 2.

On MIDI	Description	Result
B0 54 3C	Portamento Control from C4	no change
90 40 40	Note on E4	E4 is played with glide from C4 to E4
80 40 40	Note off E4	E4 off

○ **Effect 1 (Reverb Send Level) (Controller number 91)**

Status 2nd byte 3rd byte
BnH 5BH vvH

n = MIDI channel number : 0H-FH (ch.1-ch.16)
vv = Reverb Send Level : 00H-7FH (0-127), Initial Value = 28H (40)

* This message adjusts the Reverb Send Level of each Part.

○ **Effect 3 (Chorus Send Level) (Controller number 93)**

Status 2nd byte 3rd byte
BnH 5DH vvH

n = MIDI channel number : 0H-FH (ch.1-ch.16)
vv = Chorus Send Level : 00H-7FH (0-127), Initial Value = 00H (0)

* This message adjusts the Chorus Send Level of each Part.

○ **Effect 4 (Delay Send Level) (Controller number 94)**

Status 2nd byte 3rd byte
BnH 5EH vvH

n=MIDI channel number : 0H - FH (ch.1 - ch.16)
vv=Delay Send Level : 00H - 7FH (0 - 127), Initial value = 00H (0)

* This message adjusts the Delay Send Level of each Part.

* Some other GS devices may not recognize this message.

* Delay cannot be used in MODE-2 (Double Module mode).

○ **NRPN MSB/LSB (Controller number 98, 99)**

Status 2nd byte 3rd byte
BnH 63H mmH
BnH 62H llH

n = MIDI channel number : 0H-FH (ch.1-ch.16)
mm = upper byte of the parameter number specified by NRPN
ll = lower byte of the parameter number specified by NRPN

* NRPN can be received when Rx.NRPN = ON. "Rx.NRPN" is set to OFF by power-on reset or by receiving "Turn General MIDI System On," and it is set to ON by "GS RESET."

* The value set by NRPN will not be reset even if Program Change or Reset All Controllers is received.

****NRPN****

The NRPN (Non Registered Parameter Number) message allows an extended range of control changes to be used. On this unit, NRPN messages can be used to modify sound parameters etc.

To use these messages, you must first use NRPN messages (Controller number 98 and 99, their order does not matter) to specify the parameter to be controlled, and then use Data Entry messages to specify the value of the specified parameter. Once an NRPN parameter has been specified, all Data Entry messages received on that channel will modify the value of that parameter. To prevent accidents, it is recommended that you set RPN Null (RPN Number = 7FH/7FH) when you have finished setting the value of the desired parameter. Refer to Section 5, Supplementary material "Examples of actual MIDI messages" <Example 4> (page 207). On this unit, Data entry LSB (Controller number 38) of NRPN is ignored, so it is no problem to send Data entry MSB (Controller number 6) only (without Data entry LSB).

On this unit, NRPN can be used to modify the following parameters.

NRPN	Data entry	Function and range
MSB	LSB	MSB
01H 08H	mmH	Vibrato Rate (relative change) mm: 00H - 40H - 7FH (-64 - 0 - +63)
01H 09H	mmH	Vibrato Depth (relative change) mm: 00H - 40H - 7FH (-64 - 0 - +63)
01H 0AH	mmH	Vibrato Delay (relative change) mm: 00H - 40H - 7FH (-64 - 0 - +63)
01H 20H	mmH	TVF Cutoff Frequency (relative change) mm: 00H - 40H - 7FH (-64 - 0 - +63)
01H 21H	mmH	TVF Resonance (relative change) mm: 00H - 40H - 7FH (-64 - 0 - +63)
01H 63H	mmH	TVF&TVA Envelope Attack Time (relative change) mm: 00H - 40H - 7FH (-64 - 0 - +63)
01H 64H	mmH	TVF&TVA Envelope Decay Time (relative change) mm: 00H - 40H - 7FH (-64 - 0 - +63)
01H 66H	mmH	TVF&TVA Envelope Release Time (relative change) mm: 00H - 40H - 7FH (-64 - 0 - +63)
18H rrH	mmH	Drum Instrument Pitch Coarse (relative change) rr: Drum Instrument note number mm: 00H - 40H - 7FH (-64 - 0 - +63 semitone)
1AH rrH	mmH	Drum Instrument TVA Level (absolute change) rr: Drum Instrument note number mm: 00H - 7FH (0 - max)
1CH rrH	mmH	Drum Instrument Panpot (absolute change) rr: Drum Instrument note number mm: 00H, 01H - 40H - 7FH (random, left-center-right)
1DH rrH	mmH	Drum Instrument Reverb Send Level (absolute change) rr: Drum Instrument note number mm: 00H - 7FH (0 - max)
1EH rrH	mmH	Drum Instrument Chorus Send Level (absolute change) rr: Drum Instrument note number mm: 00H - 7FH (0 - max)
1FH rrH	mmH	Drum Instrument Delay Send Level (absolute change) [88] rr: Drum Instrument note number mm: 00H - 7FH (0 - max)

* Data entry LSB (llH) is ignored.

* Parameters marked "relative change" will change relative to the preset value(40H). Even among different GS devices, "relative change" parameters may sometimes differ in the way the sound changes or in the range of change.

* Parameters marked "absolute change" will be set to the absolute value of the parameter, regardless of the preset value.

* It is not possible to simultaneously use both Chorus Send Level and Delay Send Level on a single Drum Instrument.

○ RPN MSB/LSB (Controller number 100, 101)

Status	2nd byte	3rd byte
BnH	65H	mmH
BnH	64H	llH

n = MIDI channel number : 0H-FH (ch.1-ch.16)
 mm = upper byte of parameter number specified by RPN
 ll = lower byte of parameter number specified by RPN

* Not received when Rx.RPN = OFF. (Initial value is ON)
 * The value specified by RPN will not be reset even by messages such as Program Change or Reset All Controller.

RPN

The RPN (Registered Parameter Number) messages are expanded control changes, and each function of an RPN is described by the MIDI Standard. To use these messages, you must first use RPN (Controller number 100 and 110, their order does not matter) to specify the parameter to be controlled, and then use Data Entry messages (Controller number 6, 38) to specify the value of the specified parameter. Once an RPN parameter has been specified, all Data Entry messages received on that channel will modify the value of that parameter. To prevent accidents, it is recommended that you set RPN Null (RPN Number = 7FH/7FH) when you have finished setting the value of the desired parameter. Refer to Section 5. "Examples of actual MIDI messages" <Example 4> (page 207).

On this unit, RPN can be used to modify the following parameters.

RPN	Data entry	Explanation
MSB LSB	MSB LSB	
00H 00H	mmH ---	Pitch Bend Sensitivity mm: 00H-18H (0-24 semitones), Initial Value = 02H (2 semitones) ll: ignored (processed as 00H) specify up to 2 octaves in semitone steps
00H 01H	mmH llH	Master Fine Tuning mm, ll: 00 00H - 40 00H - 7F 7FH (-100 - 0 - +99.99 cents), Initial Value = 40 00H (± 0 cent) Refer to 5. Supplementary material, "About tuning" (page 208).
00H 02H	mmH ---	Master Coarse Tuning mm: 28H-40H-58H (-24 - 0 - +24 semitones), Initial Value = 40H (±0 semitone) ll: ignored (processed as 00H)
7FH 7FH	--- ---	RPN null Set condition where RPN and NRPN are unspecified. The data entry messages after set RPN null will be ignored. (No Data entry messages are required after RPN null). Settings already made will not change. mm, ll: ignored

● Program Change

Status	2nd byte
CnH	ppH

n = MIDI channel number : 0H-FH (ch.1-ch.16)
 pp = Program number : 00H-7FH (prog.1-prog.128)

* Not received when Rx.PROGRAM CHANGE = OFF. (Initial value is ON)
 * After a Program Change message is received, the sound will change beginning with the next Note-on. Voices already sounding when the Program Change message was received will not be affected.
 * For Drum Parts, Program Change message will not be received on lower byte of the bank numbers (the value of Control Number 0 is other than 0 (00H)).

● Channel Pressure

Status	2nd byte
DnH	vvH

n = MIDI channel number : 0H-FH (ch.1-ch.16)
 vv = Channel Pressure : 00H-7FH (0-127)

* Not received when Rx.CH PRESSURE (CAF) = OFF. (Initial value is ON)
 * The resulting effect is determined by System Exclusive messages. With the initial settings there will be no effect.

● Pitch Bend Change

Status	2nd byte	3rd byte
EnH	llH	mmH

n = MIDI channel number : 0H-FH (ch.1-ch.16)
 mm, ll = Pitch Bend value : 00 00H - 40 00H - 7F 7FH (-8192 - 0 - +8191)

* Not received when Rx.PITCH BEND = OFF. (Initial value is ON)
 * The resulting effect is determined by System Exclusive messages. With the initial settings the effect is Pitch Bend.

■ Channel Mode Messages

● All Sounds Off (Controller number 120)

Status	2nd byte	3rd byte
BnH	78H	00H

n = MIDI channel number : 0H-FH (ch.1-ch.16)

* When this message is received, all currently-sounding notes on the corresponding channel will be turned off immediately.

● Reset All Controllers (Controller number 121)

Status	2nd byte	3rd byte
BnH	79H	00H

n = MIDI channel number : 0H-FH (ch.1-ch.16)

* When this message is received, the following controllers will be set to their reset values.

Controller	Reset value
Pitch Bend Change	±0 (center)
Polyphonic Key Pressure	0 (off)
Channel Pressure	0 (off)
Modulation	0 (off)
Expression	127 (max)
Hold 1	0 (off)
Portamento	0 (off)
Sostenuto	0 (off)
Soft	0 (off)
RPN	unset; previously set data will not change
NRPN	unset; previously set data will not change

● All Notes Off (Controller number 123)

Status	2nd byte	3rd byte
BnH	7BH	00H

n = MIDI channel number : 0H-FH (ch.1-ch.16)

* When All Notes Off is received, all notes on the corresponding channel will be turned off. However if Hold 1 or Sostenuto is ON, the sound will be continued until these are turned off.

● OMNI OFF (Controller number 124)

Status	2nd byte	3rd byte
BnH	7CH	00H

n = MIDI channel number : 0H-FH (ch.1-ch.16)

* The same processing will be carried out as when All Notes Off is received.

● OMNI ON (Controller number 125)

Status	2nd byte	3rd byte
BnH	7DH	00H

n = MIDI channel number : 0H-FH (ch.1-ch.16)

* The same processing will be carried out as when All Note Off is received. OMNI ON will not be turned on.

● MONO (Controller number 126)

Status	2nd byte	3rd byte
BnH	7EH	mmH

n = MIDI channel number : 0H-FH (ch.1-ch.16)
 mm = mono number : 00H-10H (0-16)

* The same processing will be carried out as when All Sounds Off and All Notes Off is received, and the corresponding channel will be set to Mode 4 (M = 1) regardless of the value of "mono number."

● POLY (Controller number 127)

Status	2nd byte	3rd byte
BnH	7FH	00H

n = MIDI channel number : 0H-FH (ch.1-ch.16)

* The same processing will be carried out as when All Sounds Off and All Notes Off is received, and the corresponding channel will be set to Mode 3.

■ System Realtime Message

● Active Sensing

Status
FEH

* When Active Sensing is received, the unit will begin monitoring the intervals of all further messages. While monitoring, if the interval between messages exceeds 420 ms, the same processing will be carried out as when All Sounds Off, All Notes Off and Reset All Controllers are received, and message interval monitoring will be halted.

■ System Exclusive Message

Status	Data byte	Status
F0H	iiH, ddH,,eeH	F7H

F0H	:	System Exclusive Message status
ii = ID number	:	an ID number (manufacturer ID) to indicate the manufacturer whose Exclusive message this is. Roland's manufacturer ID is 41H. ID numbers 7EH and 7FH are extensions of the MIDI standard; Universal Non-realtime Messages (7EH) and Universal Realtime Messages (7FH).
dd,....ee = data	:	00H-7FH (0-127)
F7H	:	EOX (End Of Exclusive)

The System Exclusive Messages received by this unit are; messages related to mode settings, Universal Realtime System Exclusive messages, Data Requests (RQ1), and Data Set (DT1).

● System exclusive messages related to mode settings

These messages are used to initialize a device to GS or General MIDI mode, or change the operating mode. When creating performance data, a "Turn General MIDI System On" message should be inserted at the beginning of a General MIDI score, and a "GS Reset" message at the beginning of a GS music data. In the case of data for the SC-88 and for this unit, we recommend that "System Mode Set" be placed at the beginning of the song data. Each song should contain only one mode message as appropriate for the type of data. (Do not insert two or more mode setting messages in a single song.)
"Turn General MIDI System On" use Universal Non-realtime Message format. "System Mode Set" and "GS Reset" use Roland system exclusive format "Data Set 1 (DT1)."

○ Turn General MIDI System On

This is a command message that resets the internal settings of the unit to the General MIDI initial state (General MIDI System-Level 1). After receiving this message this unit, will automatically be set to the proper condition for correctly playing a General MIDI score.

Status	Data byte	Status
F0H	7EH, 7FH, 09H, 01H	F7H

Byte	Explanation
F0H	Exclusive status
7EH	ID number (Universal Non-realtime Message)
7FH	Device ID (Broadcast)
09H	Sub ID#1 (General MIDI Message)
01H	Sub ID#2 (General MIDI On)
F7H	EOX (End Of Exclusive)

* When this message is received, Rx.BANK SELECT will be OFF and Rx.NRPN will be OFF.

* This message will not be received when Rx.GM On = OFF (page 139).

* There must be an interval of at least 50 ms between this message and the next message.

○ GS reset

GS Reset is a command message that resets the internal settings of a device to the GS initial state. This message appears at the beginning of GS music data, and a GS device that receives this message will automatically be set to the proper state to correctly playback GS music data. If this unit is in MODE-1 (single module mode) all 32 Parts will be initialized. If in MODE-2 (double module mode), only the corresponding 16 Parts will be initialized. In MODE-2 if the receiving MIDI connector for each Part has been changed, this may affect playback from the other MIDI connector. In this case, first perform initialization (page 118) before using this command.

Status	Data byte	Status
F0H	41H, dev, 42H, 12H, 40H, 00H, 7FH, 00H, 41H	F7H

Byte	Explanation
F0H	Exclusive status
41H	ID number (Roland)
dev	Device ID (dev: 00H-1FH (1-32), Initial value is 10H (17))
42H	Model ID (GS)
12H	Command ID (DT1)
40H	Address MSB
00H	Address
7FH	Address LSB
00H	Data (GS reset)
41H	Checksum
F7H	EOX (End Of Exclusive)

* When this message is received, Rx.NRPN will be ON.

* This message will not be received if "Rx.GS Reset = OFF"(page 139).

* There must be an interval of at least 50 ms between this message and the next.

○ System Mode Set [88]

System Mode Set is a message that sets this unit operating mode to MODE-1 (single module mode) or MODE-2 (double module mode). When this message is received, the operating mode will be set, and at the same time all internal parameters (except for the map settings of each Part) will be reset to the initial state.

Status	Data byte	Status
F0H	41H, dev, 42H, 12H, 00H, 00H, 7FH, ddH, sumH	F7H

Byte	Explanation
F0H	Exclusive status
41H	ID number (Roland)
dev	Device ID (dev: 00H - 1FH (1 - 32) Initial value is 10H(17))
42H	Model ID (GS)
12H	Command ID (DT1)
00H	Address MSB
00H	Address
7FH	Address LSB
ddH	Data 00H (MODE-1), 01H (MODE-2)
sumH	Checksum 01H (MODE-1), 00H (MODE-2)
F7H	EOX (End Of Exclusive)

* When this message is received, Rx.NRPN will be set ON.

* This message will not be received when Rx.GS Reset = OFF (page 139) or Rx.Sys Mode = OFF (page 135).

* There must be an interval of at least 50 ms between this message and the next.

● Universal Realtime System Exclusive Messages

○ Master volume

Status	Data byte	Status
F0H	7FH, 7FH, 04H, 01H, llH, mmH	F7H

Byte	Explanation
F0H	Exclusive status
7FH	ID number (universal realtime message)
7FH	Device ID (Broadcast)
04H	Sub ID#1 (Device Control messages)
01H	Sub ID#2 (Master Volume)
llH	Master volume lower byte
mmH	Master volume upper byte
F7H	EOX (End Of Exclusive)

* The lower byte (llH) of Master Volume will be handled as 00H.

● Universal Non-realtime System Exclusive Messages

○ Identity Request Message

Status	Data byte	Status
F0H	7EH, dev, 06H, 01H	F7H

Byte	Explanation
F0H	Exclusive status
7EH	ID number (Universal Non-realtime Message)
dev	Device ID (dev: 00H-1FH (1-32), the initial value is 10H (17).)
06H	Sub ID#1 (General Information)
01H	Sub ID#2 (Identity Request)
F7H	EOX (End Of Exclusive)

* The "dev" is own device number or 7FH (Broadcast)

● Data transmission

This unit can use Exclusive messages to transmit internal settings to other devices. There are two types of Exclusive data transmission; Individual Parameter Transmission (page 193) in which single parameters are transmitted one by one, and Bulk Dump Transmission (page 205) in which a large amount of data is transmitted at once.

The exclusive message used when transmitting GS format data has a model ID of 42H and a device ID of 10H. (This unit allows you to change the Device ID setting.)

○ Request data 1

RQ1 (11H)

This message requests the other device to send data. The Address and Size determine the type and amount of data to be sent. There are two types of request; Individual Parameter Request which requests data for an individual parameter, and Bulk Dump Request which requests a large amount of data at once. In either case, the "Data Request 1 (RQ1)" message format is used, and the Address and Size included in the message determine the type and amount of data that is desired.

For Individual Parameter Request, refer to "3. Individual Parameter Transmission" (page 193).

For Bulk Dump Request, refer to "4. Bulk Dump" (page 205).

When a Data Request message is received, if the device is ready to transmit data and if the address and size are appropriate, the requested data will be transmitted as a "Data Set 1 (DT1)" message. If not, nothing will be transmitted.

Status	Data byte	Status
F0H	41H, dev, 42H, 11H, aaH, bbH, ccH, ssH, ttH, uuH, sum	F7H

Byte	Explanation
F0H	Exclusive status
41H	ID number (Roland)
dev	Device ID (dev: 00H - 1FH Initial value is 10H(17))
42H	Model ID (GS)
11H	Command ID (RQ1)
aaH	Address MSB : upper byte of the starting address of the requested data
bbH	Address : middle byte of the starting address of the requested data
ccH	Address LSB : lower byte of the starting address of the requested data
ssH	Size MSB
ttH	Size
uuH	Size LSB
sum	Checksum
F7H	EOX (End Of Exclusive)

* The amount of data that can be transmitted at once time will depend on the type of data, and data must be requested using a specific starting address and size. Refer to the Address and Size listed in Section 3 (page 193).
 * Regarding the checksum please refer to Section 5 (page 207).

○ **Data set 1** **DT1(12H)**

This is the message that actually performs data transmission, and is used when you wish to transmit the data.

Status	Data byte	Status
F0H	41H, dev, 42H, 12H, aaH, bbH, ccH, ddH, ... eeH, sum	F7H

Byte	Explanation
F0H	Exclusive status
41H	ID number (Roland)
dev	Device ID (dev: 00H - 1FH Initial value is 10H(17))
42H	Model ID (GS), 45H
12H	Command ID (DT1)
aaH	Address MSB : upper byte of the starting address of the transmitted data
bbH	Address : middle byte of the starting address of the transmitted data
ccH	Address LSB : lower byte of the starting address of the transmitted data
ddH	Data : the actual data to be transmitted. Multiple bytes of data are transmitted starting from the address.
:	:
eeH	Data
sum	Checksum
F7H	EOX (End Of Exclusive)

* The amount of data that can be transmitted at one time depends on the type of data, and data can be received only from the specified starting address and size. Refer to the Address and Size given in Section 3 (page 193).
 * Data larger than 128 bytes must be divided into packets of 128 bytes or less. If "Data Set 1" is transmitted successively, there must be an interval of at least 40 ms between packets.
 * Regarding the checksum please refer to section 5 (page 207).

Section 2. Transmit data

■ System Realtime Message

● Active sensing

Status
FEH

* This will be transmitted constantly at intervals of approximately 250 ms.

■ System exclusive messages

"Identity Reply" and "Data Set 1 (DT1)" are the only System Exclusive messages transmitted by this unit.
 When an appropriate "Identity Request Message" and "Data Request 1 (RQ1)" message are received, the requested internal data will be transmitted.

○ Identity Reply

Status	Data byte	Status
F0H	7EH, dev, 06H, 02H, 41H, 42H, 00H, ddH, ddH, ssH, ssH, ssH, ssH	F7H

Byte	Explanation
F0H	Exclusive status
7EH	ID number (Universal Non-realtime Message)
dev	Device ID (use the same as the device ID of Roland)
06H	Sub ID#1 (General Information)
02H	Sub ID#2 (Identity Reply)
41H	ID number (Roland)
42H	Device family code (LSB)
00H	Device family code (MSB)
ddH	Device family number code (LSB)
ddH	Device family number code (MSB)
ssH	Software revision level
ssH	Software revision level
ssH	Software revision level
ssH	Software revision level
F7H	EOX (End Of Exclusive)

* Reply the message by the unique device ID (dev) when the device has received the "Identity Request Message" in the Broadcast.

○ Data set 1

Status	Data byte	Status
F0H	41H, dev, 42H, 12H, aaH, bbH, ccH, ddH, ... eeH, sum	F7H

Byte	Explanation
F0H	Exclusive status
41H	ID number (Roland)
dev	Device ID (dev: 00H-1FH, Initial value is 10H)
42H	Model ID (GS)
12H	Command ID (DT1)
aaH	Address MSB: upper byte of the starting address of the data to be sent
bbH	Address: middle byte of the starting address of the data to be sent
ccH	Address LSB: lower byte of the starting address of the data to be sent.
ddH	Data: the actual data to be sent. Multiple bytes of data are transmitted in order starting from the address.
:	:
eeH	Data
sum	Checksum
F7H	EOX (End Of Exclusive)

* The amount of data that can be transmitted at one time depends on the type of data, and data will be transmitted from the specified starting address and size. Refer to the Address and Size given in Section 3 (page 193).
 * Data larger than 128 bytes will be divided into packets of 128 bytes or less, and each packet will be sent at an interval of about 40 ms.
 * Regarding the checksum please refer to section 4 (page 207).

There are two ways in which GS data is transmitted: Individual Parameter Transmission (Section 3 page 193) in which individual parameters are transmitted one by one, and Bulk Dump Transmission (Section 4 page 205) in which a large amount of data is transmitted at once.

Section 3. Individual Parameter Transmission (Model ID=45H or 42H)

Individual Parameter Transmission transmits data (or requests data) for one parameter as one exclusive message (one packet of "F0 F7"). In Individual Parameter Transmission, you must use the Address and Size listed in the following "Parameter Address Map". Addresses marked at "#" cannot be used as starting addresses.

Address Block map

An outlined address map of the Exclusive Communication is as follows;

<Model ID = 45H>

Address(H)	Block
10 00 00	Display Data

<Model ID = 42H>

Port-A

Address(H)	Block	Address(H)	Block
00 00 00	SYSTEM		
20 00 00	USER TONE BANK		
21 00 00	USER DRUM SET		
22 00 00	USER EFX		
23 00 00	USER PATCH COMMON		
24 00 00	USER PATCH PART (BLOCK 01)		
25 00 00	USER PATCH PART (BLOCK 01)		
26 00 00	USER PATCH PART (BLOCK 02)		
27 00 00	USER PATCH PART (BLOCK 02)		
40 00 00	PATCH COMMON #A	50 00 00	PATCH COMMON B
40 10 00	PATCH PART (BLOCK 00-0F) A	50 10 00	PATCH PART (BLOCK 10-1F) B
41 00 00	DRUM SETUP A	51 00 00	DRUM SETUP B

* The blocks displayed in gray cannot be accessed in Mode-1 (Single Module mode).

* Blocks listed as "#A" are parameter blocks which are common to the entire device in Mode-1, and valid only for Parts A01 - A16 in Mode-2 (Double Module mode).

Port-B

Address(H)	Block	Address(H)	Block
00 00 00	SYSTEM		
20 00 00	USER TONE BANK		
21 00 00	USER DRUM SET		
22 00 00	USER EFX		
23 00 00	USER PATCH COMMON		
24 00 00	USER PATCH PART (BLOCK01)		
25 00 00	USER PATCH PART (BLOCK01)		
26 00 00	USER PATCH PART (BLOCK02)		
27 00 00	USER PATCH PART (BLOCK02)		
50 00 00	PATCH COMMON A	40 00 00	PATCH COMMON #B
50 10 00	PATCH PART (BLOCK 00-0F) A	40 10 00	PATCH PART (BLOCK 10-1F) B
51 00 00	DRUM SETUP A	41 00 00	DRUM SETUP B

* The blocks displayed in gray cannot be accessed in Mode-1 (Single Module mode).

* Blocks listed as "#B" are parameter blocks which are common to the entire device in Mode-1, and valid only for Parts B01 - B16 in Mode-2 (Double Module mode).

Parameter address map

This map indicates address, size, Data (range), Parameter, Description, and Default Value of parameters which can be transferred using "Request data 1 (RQ1)" and "Data set 1 (DT1)". All the numbers of address, size, Data, and Default Value are indicated in 7-bit Hexadecimal-form. Numbers in the explanatory column are given in decimal notation. The MODEL ID = 45H parameters are related to LCD display. The MODEL ID = 42H parameters at address 5* *** are not given in this map. The parameters for address 5* *** are the same format as those at address 4* ***.

< MODEL ID = 45H >

Display data

Address(H)	Size(H)	Data(H)	Parameter	Description	Default Value(H)
10 00 00	00 00 20	20-7F	Displayed Letter	32-127(ASCII)	---
10 00 01#					
10 00 02#					
:					
10 00 1F#					

* When this message is received, a character string specified by the data will be temporarily displayed in the INSTRUMENT display area. A character string of 1 to 32 characters can be received. If more than 16 characters are received, the display will automatically be scrolled.

Address(H)	Size(H)	Data(H)	Parameter	Description	Default Value(H)
10 0p 00	00 00 40	00-1F	Displayed		
			Dot Data d00	00-31	--
10 0p 01#			Dot Data d01		
10 0p 02#			Dot Data d02		
10 0p :			Dot Data :		
10 0p 3F#			Dot Data d63		
(p:Page#			p=1:Page1, p=2:Page3, p=3:Page5, p=4:Page7, p=5:Page9)		
10 0p 40	00 00 40	00-1F	Displayed		
			Dot Data d00	00-31	--
10 0p 41#			Dot Data d01		
10 0p 42#			Dot Data d02		
10 0p :			Dot Data :		
10 0p 7F#			Dot Data d63		
(p:Page#			p=1:Page2, p=2:Page4, p=3:Page6, p=4:Page8, p=5:Page10)		

* When this message is displayed, screen data (16 x 16 dot) corresponding to the bit pattern of the Displayed Dot Data will be stored in this unit internal memory. The correspondence between data and dots is given below. The screen data which is stored can be displayed by transmitting a message for address 10 20 00.

* Only in the case of Page 1, the screen data will be temporarily displayed immediately after this message is received.

bit	4	3	2	1	0	4	3	2	1	0	4	3	2	1	0	4			
[* * d00 * *]	[* * d16 * *]	[* * d32 * *]	[* * d48]	[* * d01 * *]	[* * d17 * *]	[* * d33 * *]	[* * d49]	[* * d02 * *]	[* * d18 * *]	[* * d34 * *]	[* * d50]	[* * d03 * *]	[* * d19 * *]	[* * d35 * *]	[* * d51]	[* * d04 * *]	[* * d20 * *]	[* * d36 * *]	[* * d52]
[* * d05 * *]	[* * d21 * *]	[* * d37 * *]	[* * d53]	[* * d06 * *]	[* * d22 * *]	[* * d38 * *]	[* * d54]	[* * d07 * *]	[* * d23 * *]	[* * d39 * *]	[* * d55]	[* * d08 * *]	[* * d24 * *]	[* * d40 * *]	[* * d56]	[* * d09 * *]	[* * d25 * *]	[* * d41 * *]	[* * d57]
[* * d10 * *]	[* * d26 * *]	[* * d42 * *]	[* * d58]	[* * d11 * *]	[* * d27 * *]	[* * d43 * *]	[* * d59]	[* * d12 * *]	[* * d28 * *]	[* * d44 * *]	[* * d60]	[* * d13 * *]	[* * d29 * *]	[* * d45 * *]	[* * d61]	[* * d14 * *]	[* * d30 * *]	[* * d46 * *]	[* * d62]
[* * d15 * *]	[* * d31 * *]	[* * d47 * *]	[* * d63]	1	2	3	4	5	6	7	8	9	10	11	12	13	14	15	16

* For example, [* * d00 * *] indicates the five dots in the upper left of the display. The bit pattern of bits 4 - 0 (lower 5 bits) of the data byte turns the dots on/off. However in the case of d48 - d63, only bit 4 turns the dot on/off.

d00: 0--*****	
d01: 0--*****	
d47: 0--*****	
d48: 0--*****	
d63: 0--*****	

*: dot is unlit for 0, lit for 1
-: dot display is not affected whether this is 0 or 1

Address(H)	Size(H)	Data(H)	Parameter	Description	Default Value(H)
10 20 00	00 00 01	00-0A	Display Page	00:Bar Display 01:Page1 : : 0A:Page10	--

* When this message is received, the display (page) specified by Display Page (address 10 20 00) will be displayed for the duration of the time specified by the following Display Time (address 10 20 01).

10 20 01	00 00 01	00-0F	Display Time	0-7.2 [sec]	06 (2.88 [sec])
----------	----------	-------	--------------	-------------	-----------------

● **System Parameters [88]**

Parameters affecting the entire unit, such as how the two MIDI IN connectors will function, are called System Parameters.

<MODEL ID = 42H>

Address(H)	Size(H)	Data(H)	Parameter	Description	Default(H)	Description
00 00 7F	00 00 01	00 - 01	SYSTEM MODE SET	[88] 00: MODE-1 (Single module mode) 01: MODE-2 (Double module mode) (Rx. only)	00	MODE1

* Refer to "System exclusive messages related to Mode settings" (page 191).

Address(H)	Size(H)	Data(H)	Parameter	Description	Default(H)	Description
00 01 00	00 00 01	00 - 01	CHANNEL MSG RX PORT BLOCK00	[88] PORT A - B	00	PORT A
:	:	:	:	:	:	:
00 01 0F	00 00 01	00 - 01	BLOCK0F	PORT A - B	00	PORT A
00 01 10	00 00 01	00 - 01	BLOCK10	PORT A - B	01	PORT B
:	:	:	:	:	:	:
00 01 1F	00 00 01	00 - 01	BLOCK1F	PORT A - B	01	PORT B

* You can modify the receiving MIDI port at which channel messages will be received for each BLOCK. We suggest that normally you use PORT A for BLOCK01-0F, and PORT B for BLOCK10-1F. (In this case there is no need to change the setting.)

* Refer to page 196 for details of each BLOCK.

● **Patch parameters**

○ **Patch common parameters**

In MODE-1 (Single module mode) this unit functions as a single sound source module with 32 Parts. In MODE-2 (Double module mode) it functions as two sound source modules with 16 Parts each. The parameters common to all Parts in each module are called Patch Common parameters.

Address(H)	Size(H)	Data(H)	Parameter	Description	Default Value (H)	Description
40 00 00	00 00 04	0018 - 07E8	MASTER TUNE	-100.0 - +100.0 [cent] Use nibblized data.	00 04 00 00	0 [cent]
40 00 01#						
40 00 02#						
40 00 03#						

* Refer to section 5. Supplementary material, "About tuning" (page 208).

40 00 04	00 00 01	00 - 7F	MASTER VOLUME	0 - 127 (= F0 7F 7F 04 01 00 vv F7)	7F	127
40 00 05	00 00 01	28 - 58	MASTER KEY-SHIFT	-24 - +24 [semitones]	40	0[semitones]
40 00 06	00 00 01	01 - 7F	MASTER PAN	-63 (LEFT) - +63 (RIGHT)	40	0 (CENTER)
40 00 7F	00 00 01	00	MODE SET	00 = GS Reset (Rx. only)		

* Refer to "System exclusive messages related to Mode settings" (page 191).

40 01 00	00 00 10	20 - 7F	PATCH NAME	16 ASCII Characters		
40 01 : #						
40 01 0F#						
40 01 30	00 00 01	00 - 07	REVERB MACRO	00: Room 1 01: Room 2 02: Room 3 03: Hall 1 04: Hall 2 05: Plate 06: Delay 07: Panning Delay	04	Hall 2
40 01 31	00 00 01	00 - 07	REVERB CHARACTER	0 - 7	04	4
40 01 32	00 00 01	00 - 07	REVERB PRE-LPF	0 - 7	00	0
40 01 33	00 00 01	00 - 7F	REVERB LEVEL	0 - 127	40	64
40 01 34	00 00 01	00 - 7F	REVERB TIME	0 - 127	40	64
40 01 35	00 00 01	00 - 7F	REVERB DELAY FEEDBACK	0 - 127	00	0
40 01 37	00 00 01	00 - 7F	REVERB PREDELAY TIME	[88] 0 - 127[ms]	00	0

* REVERB MACRO is a macro parameter that allows global setting of reverb parameters. When you select the reverb type with REVERB MACRO, each reverb parameter will be set to the most suitable value.

* REVERB CHARACTER is a parameter that changes the reverb algorithm. The value of REVERB CHARACTER corresponds to the REVERB MACRO of the same number.

* In MODE-2 (Double module mode), REVERB PREDELAY TIME cannot be used.

Address(H)	Size(H)	Data(H)	Parameter	Description	Default Value (H)	Description
40 01 38	00 00 01	00 - 07	CHORUS MACRO	00: Chorus 1 01: Chorus 2 02: Chorus 3 03: Chorus 4 04: Feedback Chorus 05: Flanger 06: Short Delay 07: Short Delay(FB)	02	Chorus 3
40 01 39	00 00 01	00 - 07	CHORUS PRE-LPF	0-7	00	0
40 01 3A	00 00 01	00 - 7F	CHORUS LEVEL	0-127	40	64
40 01 3B	00 00 01	00 - 7F	CHORUS FEEDBACK	0-127	08	8
40 01 3C	00 00 01	00 - 7F	CHORUS DELAY	0-127	50	80
40 01 3D	00 00 01	00 - 7F	CHORUS RATE	0-127	03	3
40 01 3E	00 00 01	00 - 7F	CHORUS DEPTH	0-127	13	19
40 01 3F	00 00 01	00 - 7F	CHORUS SEND LEVEL TO REVERB	0-127	00	0
40 01 40	00 00 01	00 - 7F	CHORUS SEND LEVEL TO DELAY	[88] 0-127	00	0

* CHORUS MACRO is a macro parameter that allows global setting of chorus parameters. When you use CHORUS MACRO to select the chorus type, each chorus parameter will be set to the most suitable value.

* In MODE-2 (Double module mode), CHORUS SEND LEVEL TO DELAY cannot be used.

40 01 50	00 00 01	00 - 09	DELAY MACRO	[88] 00: Delay 1 01: Delay 2 02: Delay 3 03: Delay 4 04: Pan Delay 1 05: Pan Delay 2 06: Pan Delay 3 07: Pan Delay 4 08: Delay to Reverb 09: Pan Repeat	00	Delay1
40 01 51	00 00 01	00 - 07	DELAY PRE-LPF	[88] 0 - 7	00	0
40 01 52	00 00 01	01 - 73	DELAY TIME CENTER	[88] 0.1ms - 1sec	61	340
40 01 53	00 00 01	01 - 78	DELAY TIME RATIO LEFT	[88] 4 - 500%	01	4
40 01 54	00 00 01	01 - 78	DELAY TIME RATIO RIGHT	[88] 4 - 500%	01	4
40 01 55	00 00 01	00 - 7F	DELAY LEVEL CENTER	[88] 0 - 127	7F	127
40 01 56	00 00 01	00 - 7F	DELAY LEVEL LEFT	[88] 0 - 127	00	0
40 01 57	00 00 01	00 - 7F	DELAY LEVEL RIGHT	[88] 0 - 127	00	0
40 01 58	00 00 01	00 - 7F	DELAY LEVEL	[88] 0 - 127	40	64
40 01 59	00 00 01	00 - 7F	DELAY FEEDBACK	[88] -64 - +63	50	+16
40 01 5A	00 00 01	00 - 7F	DELAY SENDLEVEL TO REVERB	[88] 0 - 127	00	0

* DELAY MACRO is a macro parameter that allows global setting of delay parameters. When you use DELAY MACRO to select the delay type, each delay parameter will be set to the most suitable value.

* The relation between the DELAY TIME CENTER value and the actual delay time is as follows.

DELAY TIME	Time Range[ms]	Resolution[ms]	DELAY TIME	Time Range[ms]	Resolution[ms]
01 - 14	0.1 - 2.0	0.1	46 - 50	50.0 - 100.0	5.0
14 - 23	2.0 - 5.0	0.2	50 - 5A	100.0 - 200.0	10.0
23 - 2D	5.0 - 10.0	0.5	5A - 69	200.0 - 500.0	20.0
2D - 37	10.0 - 20.0	1.0	69 - 73	500.0 - 1000.0	50.0
37 - 46	20.0 - 50.0	2.0			

* DELAY TIME RATIO LEFT and DELAY TIME RATIO RIGHT specify the ratio in relation to DELAY TIME CENTER. The resolution is 100/24(%).

* In MODE-2 (Double module mode), Delay cannot be used.

40 02 00	00 00 01	00 - 01	EQ LOW FREQ.	[88] 200Hz, 400Hz	00	200Hz
40 02 01	00 00 01	34 - 4C	EQ LOW GAIN	[88] -12 - +12dB	40	0
40 02 02	00 00 01	00 - 01	EQ HIGH FREQ.	[88] 3kHz, 6kHz	00	3kHz
40 02 03	00 00 01	34 - 4C	EQ HIGH GAIN	[88] -12 - +12dB	40	0

* In MODE-2 (Double module mode), EQ (equalizer) cannot be used.

Address(H)	Size(H)	Data(H)	Parameter	Default Value (H)	Description
40 03 00	00 00 02	00 - 7F	EFX TYPE	00 00	00: Thru
40 03 01#					
40 03 03	00 00 01	00 - 7F	EFX PARAMETER 1	[Pro]	
40 03 04	00 00 01	00 - 7F	EFX PARAMETER 2	[Pro]	
40 03 05	00 00 01	00 - 7F	EFX PARAMETER 3	[Pro]	
40 03 06	00 00 01	00 - 7F	EFX PARAMETER 4	[Pro]	
40 03 07	00 00 01	00 - 7F	EFX PARAMETER 5	[Pro]	
40 03 08	00 00 01	00 - 7F	EFX PARAMETER 6	[Pro]	
40 03 09	00 00 01	00 - 7F	EFX PARAMETER 7	[Pro]	
40 03 0A	00 00 01	00 - 7F	EFX PARAMETER 8	[Pro]	
40 03 0B	00 00 01	00 - 7F	EFX PARAMETER 9	[Pro]	
40 03 0C	00 00 01	00 - 7F	EFX PARAMETER 10	[Pro]	
40 03 0D	00 00 01	00 - 7F	EFX PARAMETER 11	[Pro]	
40 03 0E	00 00 01	00 - 7F	EFX PARAMETER 12	[Pro]	
40 03 0F	00 00 01	00 - 7F	EFX PARAMETER 13	[Pro]	
40 03 10	00 00 01	00 - 7F	EFX PARAMETER 14	[Pro]	
40 03 11	00 00 01	00 - 7F	EFX PARAMETER 15	[Pro]	
40 03 12	00 00 01	00 - 7F	EFX PARAMETER 16	[Pro]	
40 03 13	00 00 01	00 - 7F	EFX PARAMETER 17	[Pro]	
40 03 14	00 00 01	00 - 7F	EFX PARAMETER 18	[Pro]	
40 03 15	00 00 01	00 - 7F	EFX PARAMETER 19	[Pro]	
40 03 16	00 00 01	00 - 7F	EFX PARAMETER 20	[Pro]	

* Reading EFX TYPE and EFX PARAMETER please refer to page 56, 176

Address(H)	Size(H)	Data(H)	Parameter	Description	Default Value (H)	Description
40 03 17	00 00 01	00 - 7F	EFX SEND LEVEL TO REVERB	[Pro] 0-127	28	40
40 03 18	00 00 01	00 - 7F	EFX SEND LEVEL TO CHORUS	[Pro] 0-127	00	0
40 03 19	00 00 01	00 - 7F	EFX SEND LEVEL TO DELAY	[Pro] 0-127	00	0
40 03 1B	00 00 01	00 - 7F	EFX CONTROL SOURCE1	[Pro] Off, CC1-95, CAf, Bend	00	Off
40 03 1C	00 00 01	00 - 7F	EFX CONTROL DEPTH1	[Pro] -100 - 0 - +100 [%]	40	0 (%)
40 03 1D	00 00 01	00 - 7F	EFX CONTROL SOURCE2	[Pro] Off, CC1 - 95, CAf, Bend	00	Off
40 03 1E	00 00 01	00 - 7F	EFX CONTROL DEPTH2	[Pro] -100 - 0 - +100 [%]	40	0 (%)
40 03 1F	00 00 01	00 - 7F	EFX SEND EQ SWITCH	[Pro] OFF/ON	01	ON

* EFX TYPE is a macro parameter which sets various Insertion Effect parameters as a group. When you use EFX TYPE to select an Insertion Effect type, the various effect parameters will be set to appropriate values.

* In MODE-2 (Double module mode), EFX SEND TO DELAY and EFX SEND EQ SWITCH cannot be used.

* In the case of Mode 2 (Double Module mode), the insertion effect cannot be used for Parts with a CHANNEL MSG RX PORT (page 194) setting of PORT B.

○ Patch Part parameters

This unit has 16 Parts in Group A and 16 Parts in Group B. Parameters that can be set individually for each Part are called Patch Part parameters.

If you use exclusive messages to set Patch Part parameters, specify the address by Block number rather than Part Number (normally the same number as the MIDI channel). The Block number can be specified as one of 16 blocks, from 0(H) to F(H).

To specify a Part of group A, use the Block number corresponding to the Part and specify an address of 40 *** via PORT A (normally MIDI IN A).

To specify a Part of group B, use the Block number corresponding to the Part and specify an address of 50 *** via PORT B (normally MIDI IN B).

To specify a Part of either group A or B from a single PORT, specify an address of 40 *** for group A Parts or an address of 50 *** for group B Parts when using PORT A.

Conversely, to specify a Part of either group A or B from PORT B, specify an address of 50 *** for group A Parts or an address of 40 *** for group B Parts. In other words, when specifying Parts of the opposite side as the PORT being used, use addresses 50 ***.

The relation between Part number and Block number is as follows.

x...BLOCK NUMBER (0 - F),	Part 1	(default MIDlch = 1)	x=1
	Part 2	(default MIDlch = 2)	x=2
	:	:	:
	Part 9	(default MIDlch = 9)	x=9
	Part10	(default MIDlch =10)	x=0
	Part11	(default MIDlch =11)	x=A
	Part12	(default MIDlch =12)	x=B
	:	:	:
	Part16	(default MIDlch =16)	x=F

n... MIDI channel number (0 - F) of the BLOCK.

In the following map, the control numbers of the control changes are indicated as CC#.

Address(H)	Size(H)	Data(H)	Parameter	Description	Default Value (H)	Description
40 1x 00	00 00 02	00 - 7F	TONE NUMBER	CC#00 VALUE 0 - 127	00	0
40 1x 01#		00 - 7F		P.C. VALUE 1 - 128	00	1
40 1x 02	00 00 01	00 - 10	Rx. CHANNEL	1 - 16, OFF		Same as the Part Number
40 1x 03	00 00 01	00 - 01	Rx. PITCH BEND	OFF / ON	01	ON
40 1x 04	00 00 01	00 - 01	Rx. CH PRESSURE(CAf)	OFF / ON	01	ON
40 1x 05	00 00 01	00 - 01	Rx. PROGRAM CHANGE	OFF / ON	01	ON
40 1x 06	00 00 01	00 - 01	Rx. CONTROL CHANGE	OFF / ON	01	ON
40 1x 07	00 00 01	00 - 01	Rx. POLY PRESSURE(PAf)	OFF / ON	01	ON
40 1x 08	00 00 01	00 - 01	Rx. NOTE MESSAGE	OFF / ON	01	ON
40 1x 09	00 00 01	00 - 01	Rx. RPN	OFF / ON	01	ON
40 1x 0A	00 00 01	00 - 01	Rx. NRPN	OFF / ON	00(01*)	OFF(ON*)

* When "General MIDI System On" is received, Rx. NRPN will be set OFF. When "GS Reset" is received, it will be set ON.

40 1x 0B	00 00 01	00 - 01	Rx. MODULATION	OFF / ON	01	ON
40 1x 0C	00 00 01	00 - 01	Rx. VOLUME	OFF / ON	01	ON
40 1x 0D	00 00 01	00 - 01	Rx. PANPOT	OFF / ON	01	ON
40 1x 0E	00 00 01	00 - 01	Rx. EXPRESSION	OFF / ON	01	ON
40 1x 0F	00 00 01	00 - 01	Rx. HOLD1	OFF / ON	01	ON
40 1x 10	00 00 01	00 - 01	Rx. PORTAMENTO	OFF / ON	01	ON
40 1x 11	00 00 01	00 - 01	Rx. SOSTENUTO	OFF / ON	01	ON
40 1x 12	00 00 01	00 - 01	Rx. SOFT	OFF / ON	01	ON
40 1x 13	00 00 01	00 - 01	MONO/POLY MODE	Mono / Poly (=CC# 126 01 / CC# 127 00)	01	Poly
40 1x 14	00 00 01	00 - 02	ASSIGN MODE	0 = SINGLE 1 = LIMITED-MULTI 2 = FULL-MULTI	SC-88/Native MAP 01 SC-55 MAP 00 at x=0 01 at x≠0	LIMITED-MULTI SINGLE (Drum Part) LIMITED-MULTI (Normal Part)

* ASSIGN MODE is the parameter that determines how voice assignment will be handled when sounds overlap on identical note numbers in the same channel (i.e., repeatedly struck notes). This is initialized to a mode suitable for each Part, so for general purposes there is no need to change this.

40 1x 15	00 00 01	00 - 02	USE FOR RHYTHM PART	0 = OFF 1 = MAP1 2 = MAP2	00 at x≠0 01 at x=0	OFF (Normal Part) MAP1 (Drum Part)
----------	----------	---------	---------------------	---------------------------------	------------------------	---------------------------------------

* This parameter sets the Drum Map of the Part used as the Drum Part. This unit can simultaneously (in different Parts) use up to two Drum Maps (MAP1, MAP2). With the initial settings, Part10 (MIDI CH=10, x=0) is set to MAP1 (1), and other Parts are set to normal instrumental Parts (OFF(0)).

Address(H)	Size(H)	Data(H)	Parameter	Description	Default Value (H)	Description
40 1x 16	00 00 01	28 - 58	PITCH KEY SHIFT	-24 - +24 [semitones]	40	0 [semitones]
40 1x 17	00 00 02	08 - F8	PITCH OFFSET FINE	-12.0 - +12.0 [Hz]	08 00	0 [Hz]
40 1x 18#				Use nibblized data.		

* PITCH OFFSET FINE allows you to alter, by a specified frequency amount, the pitch at which notes will sound. This parameter differs from the conventional Fine Tuning (RPN #1) parameter in that the amount of frequency alteration (in Hertz) will be identical no matter which note is played. When a multiple number of Parts, each of which has been given a different setting for PITCH OFFSET FINE, are sounded by means of an identical note number, you can obtain a Celeste effect.

40 1x 19	00 00 01	00 - 7F	PART LEVEL	0 - 127 (=CC# 7)	64	100
40 1x 1A	00 00 01	00 - 7F	VELOCITY SENSE DEPTH	0 - 127	40	64
40 1x 1B	00 00 01	00 - 7F	VELOCITY SENSE OFFSET	0 - 127	40	64
40 1x 1C	00 00 01	00 - 7F	PART PANPOT	-64(RANDOM), -63(LEFT) - +63(RIGHT) (=CC# 10, except RANDOM)	40	0 (CENTER)
40 1x 1D	00 00 01	00 - 7F	KEYBOARD RANGE LOW	(C-1) - (G9)	00	C-1
40 1x 1E	00 00 01	00 - 7F	KEYBOARD RANGE HIGH	(C-1) - (G9)	7F	G 9
40 1x 1F	00 00 01	00 - 5F	CC1 CONTROLLER NUMBER	0 - 95	10	16
40 1x 20	00 00 01	00 - 5F	CC2 CONTROLLER NUMBER	0 - 95	11	17
40 1x 21	00 00 01	00 - 7F	CHORUS SEND LEVEL	0 - 127 (=CC# 93)	00	0
40 1x 22	00 00 01	00 - 7F	REVERB SEND LEVEL	0 - 127 (=CC# 91)	28	40
40 1x 23	00 00 01	00 - 01	Rx.BANK SELECT	OFF / ON	01(00*)	ON(OFF*)

* When "General MIDI System On" is received, Rx.BANK SELECT will be set OFF. When "GS Reset" or "System Mode Set" is received, it will be set ON.

40 1x 24	00 00 01	00 - 01	RX BANK SELECT LSB	[88] OFF / ON	01	ON
----------	----------	---------	--------------------	---------------	----	----

* When RX BANK SELECT LSB = OFF, Bank Select LSB (Bn 20 11) will be treated as 00H regardless of its value.

40 1x 2A	00 00 02	00 00 - 40 00 - 7F 7F	PITCH FINE TUNE	[88] -100 - 0 - +100 [cent] (= RPN#1)	40 00	0
40 1x 2B#						
40 1x 2C	00 00 01	00 - 7F	DELAY SEND LEVEL	[88] 0-127 (=CC# 94)	00	0

* In MODE-2 (Double module mode), DELAY SEND LEVEL cannot be used.

40 1x 30	00 00 01	00 - 7F	TONE MODIFY1 Vibrato Rate	[88] -64 - +63 (=NRP# 8)	40	0
40 1x 31	00 00 01	00 - 7F	TONE MODIFY2 Vibrato Depth	[88] -64 - +63 (=NRP# 9)	40	0
40 1x 32	00 00 01	00 - 7F	TONE MODIFY3 TVF Cutoff Freq.	[88] -64 - +63 (=NRP# 32)	40	0
40 1x 33	00 00 01	00 - 7F	TONE MODIFY4 TVF Resonance	[88] -64 - +63 (=NRP# 33)	40	0
40 1x 34	00 00 01	00 - 7F	TONE MODIFY5 TVF&TVA Env.attack	[88] -64 - +63 (=NRP# 99)	40	0
40 1x 35	00 00 01	00 - 7F	TONE MODIFY6 TVF&TVA Env.decay	[88] -64 - +63 (=NRP# 100)	40	0
40 1x 36	00 00 01	00 - 7F	TONE MODIFY7 TVF&TVA Env.release	[88] -64 - +63 (=NRP# 102)	40	0
40 1x 37	00 00 01	00 - 7F	TONE MODIFY8 Vibrato Delay	[88] -64 - +63 (=NRP# 10)	40	0
40 1x 40	00 00 0C	00 - 7F	SCALE TUNING C	-64 - +63 [cent]	40	0 [cent]
40 1x 41#		00 - 7F	SCALE TUNING C#	-64 - +63 [cent]	40	0 [cent]
40 1x 42#		00 - 7F	SCALE TUNING D	-64 - +63 [cent]	40	0 [cent]
40 1x 43#		00 - 7F	SCALE TUNING D#	-64 - +63 [cent]	40	0 [cent]
40 1x 44#		00 - 7F	SCALE TUNING E	-64 - +63 [cent]	40	0 [cent]
40 1x 45#		00 - 7F	SCALE TUNING F	-64 - +63 [cent]	40	0 [cent]
40 1x 46#		00 - 7F	SCALE TUNING F#	-64 - +63 [cent]	40	0 [cent]
40 1x 47#		00 - 7F	SCALE TUNING G	-64 - +63 [cent]	40	0 [cent]
40 1x 48#		00 - 7F	SCALE TUNING G#	-64 - +63 [cent]	40	0 [cent]
40 1x 49#		00 - 7F	SCALE TUNING A	-64 - +63 [cent]	40	0 [cent]
40 1x 4A#		00 - 7F	SCALE TUNING A#	-64 - +63 [cent]	40	0 [cent]
40 1x 4B#		00 - 7F	SCALE TUNING B	-64 - +63 [cent]	40	0 [cent]

* SCALE TUNING is a function that allows fine adjustment to the pitch of each note in the octave. The pitch of each identically-named note in all octaves will change simultaneously. A setting of ± 0 cent (40H) is equal temperament (page 208).

40 2x 00	00 00 01	28 - 58	MOD PITCH CONTROL	-24 - +24 [semitones]	40	0 [semitones]
40 2x 01	00 00 01	00 - 7F	MOD TVF CUTOFF CONTROL	-9600 - +9600 [cent]	40	0 [cent]
40 2x 02	00 00 01	00 - 7F	MOD AMPLITUDE CONTROL	-100.0 - +100.0 [%]	40	0 [%]
40 2x 03	00 00 01	00 - 7F	MOD LFO1 RATE CONTROL	-10.0 - +10.0 [Hz]	40	0 [Hz]
40 2x 04	00 00 01	00 - 7F	MOD LFO1 PITCH DEPTH	0 - 600 [cent]	0A	10 [cent]
40 2x 05	00 00 01	00 - 7F	MOD LFO1 TVF DEPTH	0 - 2400 [cent]	00	0 [cent]
40 2x 06	00 00 01	00 - 7F	MOD LFO1 TVA DEPTH	0 - 100.0 [%]	00	0 [%]
40 2x 07	00 00 01	00 - 7F	MOD LFO2 RATE CONTROL	-10.0 - +10.0 [Hz]	40	0 [Hz]
40 2x 08	00 00 01	00 - 7F	MOD LFO2 PITCH DEPTH	0 - 600 [cent]	00	0 [cent]
40 2x 09	00 00 01	00 - 7F	MOD LFO2 TVF DEPTH	0 - 2400 [cent]	00	0 [cent]
40 2x 0A	00 00 01	00 - 7F	MOD LFO2 TVA DEPTH	0 - 100.0 [%]	00	0 [%]
40 2x 10	00 00 01	40 - 58	BEND PITCH CONTROL	0 - 24 [semitones]	42	2 [semitones]
40 2x 11	00 00 01	00 - 7F	BEND TVF CUTOFF CONTROL	-9600 - +9600 [cent]	40	0 [cent]
40 2x 12	00 00 01	00 - 7F	BEND AMPLITUDE CONTROL	-100.0 - +100.0 [%]	40	0 [%]
40 2x 13	00 00 01	00 - 7F	BEND LFO1 RATE CONTROL	-10.0 - +10.0 [Hz]	40	0 [Hz]
40 2x 14	00 00 01	00 - 7F	BEND LFO1 PITCH DEPTH	0 - 600 [cent]	00	0 [cent]
40 2x 15	00 00 01	00 - 7F	BEND LFO1 TVF DEPTH	0 - 2400 [cent]	00	0 [cent]
40 2x 16	00 00 01	00 - 7F	BEND LFO1 TVA DEPTH	0 - 100.0 [%]	00	0 [%]
40 2x 17	00 00 01	00 - 7F	BEND LFO2 RATE CONTROL	-10.0 - +10.0 [Hz]	40	0 [Hz]
40 2x 18	00 00 01	00 - 7F	BEND LFO2 PITCH DEPTH	0 - 600 [cent]	00	0 [cent]
40 2x 19	00 00 01	00 - 7F	BEND LFO2 TVF DEPTH	0 - 2400 [cent]	00	0 [cent]
40 2x 1A	00 00 01	00 - 7F	BEND LFO2 TVA DEPTH	0 - 100.0 [%]	00	0 [%]
40 2x 20	00 00 01	28 - 58	CAF PITCH CONTROL	-24 - +24 [semitones]	40	0 [semitones]
40 2x 21	00 00 01	00 - 7F	CAF TVF CUTOFF CONTROL	-9600 - +9600 [cent]	40	0 [cent]
40 2x 22	00 00 01	00 - 7F	CAF AMPLITUDE CONTROL	-100.0 - +100.0 [%]	40	0 [%]
40 2x 23	00 00 01	00 - 7F	CAF LFO1 RATE CONTROL	-10.0 - +10.0 [Hz]	40	0 [Hz]
40 2x 24	00 00 01	00 - 7F	CAF LFO1 PITCH DEPTH	0 - 600 [cent]	00	0 [cent]
40 2x 25	00 00 01	00 - 7F	CAF LFO1 TVF DEPTH	0 - 2400 [cent]	00	0 [cent]
40 2x 26	00 00 01	00 - 7F	CAF LFO1 TVA DEPTH	0 - 100.0 [%]	00	0 [%]
40 2x 27	00 00 01	00 - 7F	CAF LFO2 RATE CONTROL	-10.0 - +10.0 [Hz]	40	0 [Hz]
40 2x 28	00 00 01	00 - 7F	CAF LFO2 PITCH DEPTH	0 - 600 [cent]	00	0 [cent]
40 2x 29	00 00 01	00 - 7F	CAF LFO2 TVF DEPTH	0 - 2400 [cent]	00	0 [cent]
40 2x 2A	00 00 01	00 - 7F	CAF LFO2 TVA DEPTH	0 - 100.0 [%]	00	0 [%]
40 2x 30	00 00 01	28 - 58	PAF PITCH CONTROL	-24 - +24 [semitones]	40	0 [semitones]
40 2x 31	00 00 01	00 - 7F	PAF TVF CUTOFF CONTROL	-9600 - +9600 [cent]	40	0 [cent]
40 2x 32	00 00 01	00 - 7F	PAF AMPLITUDE CONTROL	-100.0 - +100.0 [%]	40	0 [%]
40 2x 33	00 00 01	00 - 7F	PAF LFO1 RATE CONTROL	-10.0 - +10.0 [Hz]	40	0 [Hz]
40 2x 34	00 00 01	00 - 7F	PAF LFO1 PITCH DEPTH	0 - 600 [cent]	00	0 [cent]
40 2x 35	00 00 01	00 - 7F	PAF LFO1 TVF DEPTH	0 - 2400 [cent]	00	0 [cent]
40 2x 36	00 00 01	00 - 7F	PAF LFO1 TVA DEPTH	0 - 100.0 [%]	00	0 [%]
40 2x 37	00 00 01	00 - 7F	PAF LFO2 RATE CONTROL	-10.0 - +10.0 [Hz]	40	0 [Hz]
40 2x 38	00 00 01	00 - 7F	PAF LFO2 PITCH DEPTH	0 - 600 [cent]	00	0 [cent]
40 2x 39	00 00 01	00 - 7F	PAF LFO2 TVF DEPTH	0 - 2400 [cent]	00	0 [cent]
40 2x 3A	00 00 01	00 - 7F	PAF LFO2 TVA DEPTH	0 - 100.0 [%]	00	0 [%]

40 2x 40	00 00 01	28 - 58	CC1 PITCH CONTROL	-24 - +24 [semitones]	40	0 [semitones]
40 2x 41	00 00 01	00 - 7F	CC1 TVF CUTOFF CONTROL	-9600 - +9600 [cent]	40	0 [cent]
40 2x 42	00 00 01	00 - 7F	CC1 AMPLITUDE CONTROL	-100.0 - +100.0 [%]	40	0 [%]
40 2x 43	00 00 01	00 - 7F	CC1 LFO1 RATE CONTROL	-10.0 - +10.0 [Hz]	40	0 [Hz]
40 2x 44	00 00 01	00 - 7F	CC1 LFO1 PITCH DEPTH	0 - 600 [cent]	00	0 [cent]
40 2x 45	00 00 01	00 - 7F	CC1 LFO1 TVF DEPTH	0 - 2400 [cent]	00	0 [cent]
40 2x 46	00 00 01	00 - 7F	CC1 LFO1 TVA DEPTH	0 - 100.0 [%]	00	0 [%]
40 2x 47	00 00 01	00 - 7F	CC1 LFO2 RATE CONTROL	-10.0 - +10.0 [Hz]	40	0 [Hz]
40 2x 48	00 00 01	00 - 7F	CC1 LFO2 PITCH DEPTH	0 - 600 [cent]	00	0 [cent]
40 2x 49	00 00 01	00 - 7F	CC1 LFO2 TVF DEPTH	0 - 2400 [cent]	00	0 [cent]
40 2x 4A	00 00 01	00 - 7F	CC1 LFO2 TVA DEPTH	0 - 100.0 [%]	00	0 [%]
40 2x 50	00 00 01	28 - 58	CC2 PITCH CONTROL	-24 - +24 [semitones]	40	0 [semitones]
40 2x 51	00 00 01	00 - 7F	CC2 TVF CUTOFF CONTROL	-9600 - +9600 [cent]	40	0 [cent]
40 2x 52	00 00 01	00 - 7F	CC2 AMPLITUDE CONTROL	-100.0 - +100.0 [%]	40	0 [%]
40 2x 53	00 00 01	00 - 7F	CC2 LFO1 RATE CONTROL	-10.0 - +10.0 [Hz]	40	0 [Hz]
40 2x 54	00 00 01	00 - 7F	CC2 LFO1 PITCH DEPTH	0 - 600 [cent]	00	0 [cent]
40 2x 55	00 00 01	00 - 7F	CC2 LFO1 TVF DEPTH	0 - 2400 [cent]	00	0 [cent]
40 2x 56	00 00 01	00 - 7F	CC2 LFO1 TVA DEPTH	0 - 100.0 [%]	00	0 [%]
40 2x 57	00 00 01	00 - 7F	CC2 LFO2 RATE CONTROL	-10.0 - +10.0 [Hz]	40	0 [Hz]
40 2x 58	00 00 01	00 - 7F	CC2 LFO2 PITCH DEPTH	0 - 600 [cent]	00	0 [cent]
40 2x 59	00 00 01	00 - 7F	CC2 LFO2 TVF DEPTH	0 - 2400 [cent]	00	0 [cent]
40 2x 5A	00 00 01	00 - 7F	CC2 LFO2 TVA DEPTH	0 - 100.0 [%]	00	0 [%]

* You may not always be able to obtain the desired effect by modifying the LFO 1 and LFO 2 parameters.

40 4x 00	00 00 01	00 - 03	TONE MAP NUMBER (= CC#32 : Bank number LSB)	[Pro] MAP 0 - 3 00 : SELECTED 01 : SC-55 MAP 02 : SC-88 MAP 03 : Native MAP	00	
----------	----------	---------	--	---	----	--

*When "GS Reset" is received, this will be 00: SELECTED.

40 4x 01	00 00 01	01 - 03	TONE MAP-0 NUMBER	[Pro] 01 : SC-55 MAP 02 : SC-88 MAP 03 : Native MAP	(03)	
----------	----------	---------	-------------------	---	------	--

* When TONE MAP NUMBER is 00, this specifies the MAP. This setting will not be reset when the power is turned on or when "GS Reset", "General MIDI System On" or "System Mode Set" is received.

40 4x 20	00 00 01	00 - 01	EQ ON/OFF	[88] OFF / ON	01	ON
----------	----------	---------	-----------	---------------	----	----

* This turns the EQ (equalizer) on/off. In MODE-2 (Double module mode) it cannot be used.

40 4x 21	00 00 01	00 - 03	OUTPUT ASSIGN	[Pro] 00:OUTPUT-1 01:OUTPUT-2 02:OUTPUT-2L 03:OUTPUT-2R	00	OUTPUT-1
40 4x 22	00 00 01	00 - 01	PART EFX ASSIGN	[Pro] 00:BYPASS 01:EFX	00	BYPASS

● Drum setup parameters

m: Map number (0 = MAP1, 1 = MAP2)

rr: drum part note number (00H - 7FH: 0 - 127)

Address(H)	Size(H)	Data(H)	Parameter	Description
41 m0 00	00 00 0C	20 - 7F	DRUM MAP NAME	ASCII Character
41 m0 0B#				
41 m1 rr	00 00 01	00 - 7F	PLAY NOTE NUMBER	Pitch coarse
41 m2 rr	00 00 01	00 - 7F	LEVEL	TVA level (=NRP# 26)
41 m3 rr	00 00 01	00 - 7F	ASSIGN GROUP NUMBER	Non, 1 - 127
41 m4 rr	00 00 01	00 - 7F	PANPOT	-64(RANDOM), -63(LEFT) - +63(RIGHT) (=NRP# 28, except RANDOM)
41 m5 rr	00 00 01	00 - 7F	REVERB SEND LEVEL	0.0 - 1.0 Multiplicand of the part reverb level (=NRP# 29)
41 m6 rr	00 00 01	00 - 7F	CHORUS SEND LEVEL	0.0 - 1.0 Multiplicand of the part chorus level (=NRP# 30)
41 m7 rr	00 00 01	00 - 01	Rx. NOTE OFF	OFF / ON
41 m8 rr	00 00 01	00 - 01	Rx. NOTE ON	OFF / ON
41 m9 rr	00 00 01	00 - 7F	DELAY SEND LEVEL	[88] 0.0 - 1.0 Multiplicand of the part delay level (=NRP# 31)

* When the Drum Set is changed, DRUM SETUP PARAMETER values will all be initialized.

* It is not possible to simultaneously use both Chorus Send Level and Delay Send Level for a single Drum Instrument.

● **User instrument**

You can modify the parameters of this unit sound to your taste, and save your new settings in Variation numbers 64 or 65 of the Native map / SC-88 map (page 98). A sound saved in this way is called a User Instrument. You can save 256 different sounds in this way. The parameters you can set are Vibrato, Filter and Envelope.

b: bank number (0H = GS Variation number 64, 1H = GS Variation number 65)
pp: program number (00 - 7F : 1 - 128)

Address(H)	Size(H)	Data(H)	Parameter	Description	Default Value (H)	Description
20 b0 pp	00 00 01	01 - 03	SOURCE TONE# (MAP)	[88] --		
20 b1 pp	00 00 01	00 - 7F	(CC#00 : Bank number MSB)	[88] --		
20 b2 pp	00 00 01	00 - 7F	(PG# : Program number)	[88] --		
20 b3 pp	00 00 01	00 - 7F	USER INST MODIFY1-2 Vibrato Rate	[88] -64 - +63	40	0
20 b4 pp	00 00 01	00 - 7F	USER INST MODIFY2-2 Vibrato Depth	[88] -64 - +63	40	0
20 b5 pp	00 00 01	00 - 7F	USER INST MODIFY3-2 TVF Cutoff Freq	[88] -64 - +63	40	0
20 b6 pp	00 00 01	00 - 7F	USER INST MODIFY4-2 TVF Resonance	[88] -64 - +63	40	0
20 b7 pp	00 00 01	00 - 7F	USER INST MODIFY5-2 TVF&TVA Env.attack	[88] -64 - +63	40	0
20 b8 pp	00 00 01	00 - 7F	USER INST MODIFY6-2 TVF&TVA Env.decay	[88] -64 - +63	40	0
20 b9 pp	00 00 01	00 - 7F	USER INST MODIFY7-2 TVF&TVA Env.release	[88] -64 - +63	40	0
20 bA pp	00 00 01	00 - 7F	USER INST MODIFY8-2 Vibrato Delay	[88] -64 - +63	40	0

● **User Drum Set**

You can modify drum instrument parameters to your liking, and save this data as a Drum Set. A Drum Set saved in this way is called a User Drum Set. You can save up to two Drum Sets, and since each set contains 128 instrumental sounds, this provides a total of 256 instrumental sounds (Drum Instruments). You can also give each User Drum Set a name of your choice. User Drum Sets are stored in Drum Set numbers 65 and 66 of the Native map / SC-88 map.

d: drum set number (0H = User drum set number 65, 1H = User Drum Set number 66)
rr: drum part note number (00 - 7F)

Address(H)	Size(H)	Data(H)	Parameter	Description
21 d0 00	00 00 0C	20 - 7F	USER DRUM SET NAME	[88] 32 - 127 (ASCII 12 characters)
21 d0 0B#				
21 d1 rr	00 00 01	00 - 7F	PLAY NOTE	[88] 0 - 127
21 d2 rr	00 00 01	00 - 7F	LEVEL	[88] 0 - 127
21 d3 rr	00 00 01	00 - 7F	ASSIGN GROUP	[88] 0 - 127
21 d4 rr	00 00 01	00 - 7F	PAN	[88] 0 - 127
21 d5 rr	00 00 01	00 - 7F	REVERB SEND LEVEL	[88] 0 - 127
21 d6 rr	00 00 01	00 - 7F	CHORUS SEND LEVEL	[88] 0 - 127
21 d7 rr	00 00 01	00 - 01	RX NOTE OFF	[88] OFF / ON
21 d8 rr	00 00 01	00 - 01	RX NOTE ON	[88] OFF / ON
21 d9 rr	00 00 01	00 - 7F	DELAY SEND LEVEL	[88] 0 - 127
21 dA rr	00 00 01	01 - 03	SOURCE DRUM SET# (MAP)	[88] 1 - 3
21 dB rr	00 00 01	00 - 7F	(PG#: Program number)	[88] 0 - 127
21 dC rr	00 00 01	00 - 7F	SOURCE NOTE NUMBER	[88] 0 - 127

● **User Effect**

You can modify the Insertion Effect parameters as desired and store them as an Effect Type. Effect Types that are stored in this way are referred to as User Effects. 64 different Effect Types can be stored. These are stored in Effect Type numbers 40 00H through 40 3FH.

pp: LSB number of EFX TYPE (00 - 3F : 0-64)

Address(H)	Size(H)	Data(H)	Parameter	
22 00 pp	00 00 02	--	SOURCE EFX TYPE	[Pro]
22 01 pp#				
22 03 pp	00 00 01	00 - 7F	EFX PARAMETER 1	[Pro]
22 04 pp	00 00 01	00 - 7F	EFX PARAMETER 2	[Pro]
22 05 pp	00 00 01	00 - 7F	EFX PARAMETER 3	[Pro]
22 06 pp	00 00 01	00 - 7F	EFX PARAMETER 4	[Pro]
22 07 pp	00 00 01	00 - 7F	EFX PARAMETER 5	[Pro]
22 08 pp	00 00 01	00 - 7F	EFX PARAMETER 6	[Pro]
22 09 pp	00 00 01	00 - 7F	EFX PARAMETER 7	[Pro]
22 0A pp	00 00 01	00 - 7F	EFX PARAMETER 8	[Pro]
22 0B pp	00 00 01	00 - 7F	EFX PARAMETER 9	[Pro]
22 0C pp	00 00 01	00 - 7F	EFX PARAMETER 10	[Pro]
22 0D pp	00 00 01	00 - 7F	EFX PARAMETER 11	[Pro]
22 0E pp	00 00 01	00 - 7F	EFX PARAMETER 12	[Pro]
22 0F pp	00 00 01	00 - 7F	EFX PARAMETER 13	[Pro]
22 10 pp	00 00 01	00 - 7F	EFX PARAMETER 14	[Pro]
22 11 pp	00 00 01	00 - 7F	EFX PARAMETER 15	[Pro]
22 12 pp	00 00 01	00 - 7F	EFX PARAMETER 16	[Pro]
22 13 pp	00 00 01	00 - 7F	EFX PARAMETER 17	[Pro]
22 14 pp	00 00 01	00 - 7F	EFX PARAMETER 18	[Pro]
22 15 pp	00 00 01	00 - 7F	EFX PARAMETER 19	[Pro]
22 16 pp	00 00 01	00 - 7F	EFX PARAMETER 20	[Pro]

● **User Patch**

All Patch Common and Patch Part parameters (limited to Part 1 and Part 2) can be adjusted as desired, and saved as a Patch. Patches saved in this way are referred to as User Patches. 16 different User Patches can be saved.

● **User Patch Common**

pp : Patch number (00 - 0F : 1-16)

Address(H)	Size(H)	Data(H)	Parameter	
23 pp 00	00 00 04	0018 - 07E8	MASTER TUNE	[Pro] -100.0 - +100.0 [cent]
23 pp 01#				
23 pp 02#				
23 pp 03#				
23 pp 04	00 00 01	00 - 7F	MASTER VOLUME	[Pro] 0 - 127
23 pp 05	00 00 01	28 - 58	MASTER KEY-SHIFT	[Pro] -24 - +24 [semitones]
23 pp 06	00 00 01	01 - 7F	MASTER PAN	[Pro] -63 - +63
23 pp 08	00 00 10	20 - 7F	PATCH NAME	[Pro] 16 ASCII Characters
23 pp : #				
23 pp 17#				
23 pp 18	00 00 01	00 - 07	REVERB MACRO	[Pro] Room 1 - PDelay
23 pp 19	00 00 01	00 - 07	REVERB CHARACTER	[Pro] 0 - 7
23 pp 1A	00 00 01	00 - 07	REVERB PRE-LPF	[Pro] 0 - 7
23 pp 1B	00 00 01	00 - 7F	REVERB LEVEL	[Pro] 0 - 127
23 pp 1C	00 00 01	00 - 7F	REVERB TIME	[Pro] 0 - 127
23 pp 1D	00 00 01	00 - 7F	REVERB DELAY FEEDBACK	[Pro] 0 - 127
23 pp 1F	00 00 01	00 - 7F	REVERB PREDELAY TIME	[Pro] 0 - 127[ms]
* In MODE-2 (Double module mode), REVERB PREDELAY TIME cannot be used.				
23 pp 20	00 00 01	00 - 07	CHORUS MACRO	[Pro] Chorus 1 - SDelay(FB)
23 pp 21	00 00 01	00 - 07	CHORUS PRE-LPF	[Pro] 0-7
23 pp 22	00 00 01	00 - 7F	CHORUS LEVEL	[Pro] 0-127
23 pp 23	00 00 01	00 - 7F	CHORUS FEEDBACK	[Pro] 0-127
23 pp 24	00 00 01	00 - 7F	CHORUS DELAY	[Pro] 0-127
23 pp 25	00 00 01	00 - 7F	CHORUS RATE	[Pro] 0-127
23 pp 26	00 00 01	00 - 7F	CHORUS DEPTH	[Pro] 0-127
23 pp 27	00 00 01	00 - 7F	CHORUS SEND LEVEL TO REVERB	[Pro] 0-127
23 pp 28	00 00 01	00 - 7F	CHORUS SEND LEVEL TO DELAY	[Pro] 0-127
* In MODE-2 (Double module mode), CHORUS SEND LEVEL TO DELAY cannot be used.				
23 pp 29	00 00 01	00 - 09	DELAY MACRO	[Pro] Delay 1 - Pan Repeat
23 pp 2A	00 00 01	00 - 07	DELAY PRE-LPF	[Pro] 0 - 7
23 pp 2B	00 00 01	01 - 73	DELAY TIME CENTER	[Pro] 0.1ms - 1sec
23 pp 2C	00 00 01	01 - 78	DELAY TIME RATIO LEFT	[Pro] 4 - 500%
23 pp 2D	00 00 01	01 - 78	DELAY TIME RATIO RIGHT	[Pro] 4 - 500%
23 pp 2E	00 00 01	00 - 7F	DELAY LEVEL CENTER	[Pro] 0 - 127
23 pp 2F	00 00 01	00 - 7F	DELAY LEVEL LEFT	[Pro] 0 - 127
23 pp 30	00 00 01	00 - 7F	DELAY LEVEL RIGHT	[Pro] 0 - 127
23 pp 31	00 00 01	00 - 7F	DELAY LEVEL	[Pro] 0 - 127
23 pp 32	00 00 01	00 - 7F	DELAY FEEDBACK	[Pro] -64 - +63
23 pp 33	00 00 01	00 - 7F	DELAY SENDLEVEL TO REVERB	[Pro] 0 - 127
* In MODE-2 (Double module mode), DELAY cannot be used.				
23 pp 34	00 00 01	00 - 01	EQ LOW FREQ	[Pro] 200Hz, 400Hz
23 pp 35	00 00 01	34 - 4C	EQ LOW GAIN	[Pro] -12 - +12dB
23 pp 36	00 00 01	00 - 01	EQ HIGH FREQ	[Pro] 3kHz, 6kHz
23 pp 37	00 00 01	34 - 4C	EQ HIGH GAIN	[Pro] -12 - +12dB
* In MODE-2 (Double module mode), EQ cannot be used.				

23 pp 40	00 00 02	00 - 7F	EFX TYPE	[Pro]
23 pp 41#				
23 pp 43	00 00 01	00 - 7F	EFX PARAMETER 1	[Pro]
23 pp 44	00 00 01	00 - 7F	EFX PARAMETER 2	[Pro]
23 pp 45	00 00 01	00 - 7F	EFX PARAMETER 3	[Pro]
23 pp 46	00 00 01	00 - 7F	EFX PARAMETER 4	[Pro]
23 pp 47	00 00 01	00 - 7F	EFX PARAMETER 5	[Pro]
23 pp 48	00 00 01	00 - 7F	EFX PARAMETER 6	[Pro]
23 pp 49	00 00 01	00 - 7F	EFX PARAMETER 7	[Pro]
23 pp 4A	00 00 01	00 - 7F	EFX PARAMETER 8	[Pro]
23 pp 4B	00 00 01	00 - 7F	EFX PARAMETER 9	[Pro]
23 pp 4C	00 00 01	00 - 7F	EFX PARAMETER 10	[Pro]
23 pp 4D	00 00 01	00 - 7F	EFX PARAMETER 11	[Pro]
23 pp 4E	00 00 01	00 - 7F	EFX PARAMETER 12	[Pro]
23 pp 4F	00 00 01	00 - 7F	EFX PARAMETER 13	[Pro]
23 pp 50	00 00 01	00 - 7F	EFX PARAMETER 14	[Pro]
23 pp 51	00 00 01	00 - 7F	EFX PARAMETER 15	[Pro]
23 pp 52	00 00 01	00 - 7F	EFX PARAMETER 16	[Pro]
23 pp 53	00 00 01	00 - 7F	EFX PARAMETER 17	[Pro]
23 pp 54	00 00 01	00 - 7F	EFX PARAMETER 18	[Pro]
23 pp 55	00 00 01	00 - 7F	EFX PARAMETER 19	[Pro]
23 pp 56	00 00 01	00 - 7F	EFX PARAMETER 20	[Pro]
23 pp 57	00 00 01	00 - 7F	EFX SEND LEVEL TO REVERB	[Pro]
23 pp 58	00 00 01	00 - 7F	EFX SEND LEVEL TO CHORUS	[Pro]
23 pp 59	00 00 01	00 - 7F	EFX SEND LEVEL TO DELAY	[Pro]
23 pp 5B	00 00 01	00 - 7F	EFX CONTROL SOURCE1	[Pro]
23 pp 5C	00 00 01	00 - 7F	EFX CONTROL DEPTH1	[Pro]
23 pp 5D	00 00 01	00 - 7F	EFX CONTROL SOURCE	[Pro]
23 pp 5E	00 00 01	00 - 7F	EFX CONTROL DEPTH2	[Pro]
23 pp 5F	00 00 01	00 - 7F	EFX SEND EQ SWITCH	[Pro]

* In the case of Mode 2 (Double Module mode), the insertion effect cannot be used for Parts with a CHANNEL MSG RX PORT (page 194) setting of PORT B.

○ User Patch Part

2a : Patch part number (Part1: a=4, Part2: a=6)

2b : Patch part number (Part1: b=5, Part2: b=7)

pp : Patch number(00 - 0F : 1-16)

Address(H)	Size(H)	Data(H)	Parameter		
2a pp 00	00 00 02	00 - 7F	TONE NUMBER	[Pro]	CC#00 VALUE: 0 - 127 P.C. VALUE: 1 - 128
2a pp 01#		00 - 7F			
2a pp 02	00 00 01	00 - 10	Rx. CHANNEL	[Pro]	1 - 16, OFF
2a pp 03	00 00 01	00 - 01	Rx. PITCH BEND	[Pro]	OFF / ON
2a pp 04	00 00 01	00 - 01	Rx. CH PRESSURE (Caf)	[Pro]	OFF / ON
2a pp 05	00 00 01	00 - 01	Rx. PROGRAM CHANGE	[Pro]	OFF / ON
2a pp 06	00 00 01	00 - 01	Rx. CONTROL CHANGE	[Pro]	OFF / ON
2a pp 07	00 00 01	00 - 01	Rx. POLY PRESSURE (Paf)	[Pro]	OFF / ON
2a pp 08	00 00 01	00 - 01	Rx. NOTE MESSAGE	[Pro]	OFF / ON
2a pp 09	00 00 01	00 - 01	Rx. RPN	[Pro]	OFF / ON
2a pp 0A	00 00 01	00 - 01	Rx. NRPN	[Pro]	OFF / ON
2a pp 0B	00 00 01	00 - 01	Rx. MODULATION	[Pro]	OFF / ON
2a pp 0C	00 00 01	00 - 01	Rx. VOLUME	[Pro]	OFF / ON
2a pp 0D	00 00 01	00 - 01	Rx. PANPOT	[Pro]	OFF / ON
2a pp 0E	00 00 01	00 - 01	Rx. EXPRESSION	[Pro]	OFF / ON
2a pp 0F	00 00 01	00 - 01	Rx. HOLD1	[Pro]	OFF / ON
2a pp 10	00 00 01	00 - 01	Rx. PORTAMENTO	[Pro]	OFF / ON
2a pp 11	00 00 01	00 - 01	Rx. SOSTENUTO	[Pro]	OFF / ON
2a pp 12	00 00 01	00 - 01	Rx. SOFT	[Pro]	OFF / ON
2a pp 13	00 00 01	00 - 01	MONO/POLY MODE	[Pro]	Mono / Poly
2a pp 14	00 00 01	00 - 02	ASSIGN MODE	[Pro]	SINGLE - FULL MULTI
2a pp 15	00 00 01	00 - 02	USE FOR RHYTHM PART	[Pro]	OFF - MAP2
2a pp 16	00 00 01	28 - 58	PITCH KEY SHIFT	[Pro]	-24 - +24 [semitones]
2a pp 17	00 00 02	08 - F8	PITCH OFFSET FINE	[Pro]	-12.0 - +12.0 [Hz]
2a pp 19	00 00 01	00 - 7F	PART LEVEL	[Pro]	0 - 127
2a pp 1A	00 00 01	00 - 7F	VELOCITY SENSE DEPTH	[Pro]	0 - 127
2a pp 1B	00 00 01	00 - 7F	VELOCITY SENSE OFFSET	[Pro]	0 - 127
2a pp 1C	00 00 01	00 - 7F	PART PANPOT	[Pro]	Random, L63 - R63
2a pp 1D	00 00 01	00 - 7F	KEYBOARD RANGE LOW	[Pro]	0 - 127
2a pp 1E	00 00 01	00 - 7F	KEYBOARD RANGE HIGH	[Pro]	0 - 127
2a pp 1F	00 00 01	00 - 5F	CC1 CONTROLLER NUMBER	[Pro]	0 - 95
2a pp 20	00 00 01	00 - 5F	CC2 CONTROLLER NUMBER	[Pro]	0 - 95
2a pp 21	00 00 01	00 - 7F	CHORUS SEND LEVEL	[Pro]	0 - 127
2a pp 22	00 00 01	00 - 7F	REVERB SEND LEVEL	[Pro]	0 - 127
2a pp 23	00 00 01	00 - 01	Rx.BANK SELECT	[Pro]	OFF / ON
2a pp 24	00 00 01	00 - 01	RX BANK SELECT LSB	[Pro]	OFF / ON
2a pp 2A	00 00 02	00 00 - 7F 7F	PITCH FINE TUNE	[Pro]	-100 - 0 - +100[cent]
2a pp 2B#					
2a pp 2C	00 00 01	00 - 7F	DELAY SEND LEVEL	[Pro]	0 - 127

* In MODE-2 (Double module mode), DELAY SEND LEVEL cannot be used.

2a pp 30	00 00 01	00 - 7F	TONE MODIFY1	[Pro]	-64 - +63 Vibrato Rate
2a pp 31	00 00 01	00 - 7F	TONE MODIFY2	[Pro]	-64 - +63 Vibrato Depth
2a pp 32	00 00 01	00 - 7F	TONE MODIFY3	[Pro]	-64 - +63 TVF Cutoff Freq
2a pp 33	00 00 01	00 - 7F	TONE MODIFY4	[Pro]	-64 - +63 TVF Resonance
2a pp 34	00 00 01	00 - 7F	TONE MODIFY5	[Pro]	-64 - +63 TVF&TVA Env.attack
2a pp 35	00 00 01	00 - 7F	TONE MODIFY6	[Pro]	-64 - +63 TVF&TVA Env.decay
2a pp 36	00 00 01	00 - 7F	TONE MODIFY7	[Pro]	-64 - +63 TVF&TVA Env.release
2a pp 37	00 00 01	00 - 7F	TONE MODIFY8	[Pro]	-64 - +63 Vibrato Delay
2a pp 40	00 00 0C	00 - 7F	SCALE TUNING C	[Pro]	-64 - +63 [cent]
2a pp : #					
2a pp 4B#		00 - 7F	SCALE TUNING B	[Pro]	-64 - +63 [cent]
2a pp 50	00 00 01	28 - 58	MOD PITCH CONTROL	[Pro]	-24 - +24 [semitones]
2a pp 51	00 00 01	00 - 7F	MOD TVF CUTOFF CONTROL	[Pro]	-9600 - +9600 [cent]
2a pp 52	00 00 01	00 - 7F	MOD AMPLITUDE CONTROL	[Pro]	-100.0 - +100.0 [%]
2a pp 53	00 00 01	00 - 7F	MOD LFO1 RATE CONTROL	[Pro]	-10.0 - +10.0 [Hz]
2a pp 54	00 00 01	00 - 7F	MOD LFO1 PITCH DEPTH	[Pro]	0 - 600 [cent]
2a pp 55	00 00 01	00 - 7F	MOD LFO1 TVF DEPTH	[Pro]	0 - 2400 [cent]
2a pp 56	00 00 01	00 - 7F	MOD LFO1 TVA DEPTH	[Pro]	0 - 100.0 [%]
2a pp 57	00 00 01	00 - 7F	MOD LFO2 RATE CONTROL	[Pro]	-10.0 - +10.0 [Hz]
2a pp 58	00 00 01	00 - 7F	MOD LFO2 PITCH DEPTH	[Pro]	0 - 600 [cent]
2a pp 59	00 00 01	00 - 7F	MOD LFO2 TVF DEPTH	[Pro]	0 - 2400 [cent]
2a pp 5A	00 00 01	00 - 7F	MOD LFO2 TVA DEPTH	[Pro]	0 - 100.0 [%]
2a pp 60	00 00 01	40 - 58	BEND PITCH CONTROL	[Pro]	0 - 24 [semitones]
2a pp 61	00 00 01	00 - 7F	BEND TVF CUTOFF CONTROL	[Pro]	-9600 - +9600 [cent]
2a pp 62	00 00 01	00 - 7F	BEND AMPLITUDE CONTROL	[Pro]	-100.0 - +100.0 [%]
2a pp 63	00 00 01	00 - 7F	BEND LFO1 RATE CONTROL	[Pro]	-10.0 - +10.0 [Hz]
2a pp 64	00 00 01	00 - 7F	BEND LFO1 PITCH DEPTH	[Pro]	0 - 600 [cent]
2a pp 65	00 00 01	00 - 7F	BEND LFO1 TVF DEPTH	[Pro]	0 - 2400 [cent]
2a pp 66	00 00 01	00 - 7F	BEND LFO1 TVA DEPTH	[Pro]	0 - 100.0 [%]
2a pp 67	00 00 01	00 - 7F	BEND LFO2 RATE CONTROL	[Pro]	-10.0 - +10.0 [Hz]
2a pp 68	00 00 01	00 - 7F	BEND LFO2 PITCH DEPTH	[Pro]	0 - 600 [cent]
2a pp 69	00 00 01	00 - 7F	BEND LFO2 TVF DEPTH	[Pro]	0 - 2400 [cent]
2a pp 6A	00 00 01	00 - 7F	BEND LFO2 TVA DEPTH	[Pro]	0 - 100.0 [%]
2a pp 70	00 00 01	28 - 58	CAf PITCH CONTROL	[Pro]	-24 - +24 [semitones]
2a pp 71	00 00 01	00 - 7F	CAf TVF CUTOFF CONTROL	[Pro]	-9600 - +9600 [cent]
2a pp 72	00 00 01	00 - 7F	CAf AMPLITUDE CONTROL	[Pro]	-100.0 - +100.0 [%]
2a pp 73	00 00 01	00 - 7F	CAf LFO1 RATE CONTROL	[Pro]	-10.0 - +10.0 [Hz]
2a pp 74	00 00 01	00 - 7F	CAf LFO1 PITCH DEPTH	[Pro]	0 - 600 [cent]
2a pp 75	00 00 01	00 - 7F	CAf LFO1 TVF DEPTH	[Pro]	0 - 2400 [cent]
2a pp 76	00 00 01	00 - 7F	CAf LFO1 TVA DEPTH	[Pro]	0 - 100.0 [%]
2a pp 77	00 00 01	00 - 7F	CAf LFO2 RATE CONTROL	[Pro]	-10.0 - +10.0 [Hz]
2a pp 78	00 00 01	00 - 7F	CAf LFO2 PITCH DEPTH	[Pro]	0 - 600 [cent]
2a pp 79	00 00 01	00 - 7F	CAf LFO2 TVF DEPTH	[Pro]	0 - 2400 [cent]
2a pp 7A	00 00 01	00 - 7F	CAf LFO2 TVA DEPTH	[Pro]	0 - 100.0 [%]
2b pp 00	00 00 01	28 - 58	PAf PITCH CONTROL	[Pro]	-24 - +24 [semitones]
2b pp 01	00 00 01	00 - 7F	PAf TVF CUTOFF CONTROL	[Pro]	-9600 - +9600 [cent]
2b pp 02	00 00 01	00 - 7F	PAf AMPLITUDE CONTROL	[Pro]	-100.0 - +100.0 [%]
2b pp 03	00 00 01	00 - 7F	PAf LFO1 RATE CONTROL	[Pro]	-10.0 - +10.0 [Hz]
2b pp 04	00 00 01	00 - 7F	PAf LFO1 PITCH DEPTH	[Pro]	0 - 600 [cent]
2b pp 05	00 00 01	00 - 7F	PAf LFO1 TVF DEPTH	[Pro]	0 - 2400 [cent]
2b pp 06	00 00 01	00 - 7F	PAf LFO1 TVA DEPTH	[Pro]	0 - 100.0 [%]
2b pp 07	00 00 01	00 - 7F	PAf LFO2 RATE CONTROL	[Pro]	-10.0 - +10.0 [Hz]
2b pp 08	00 00 01	00 - 7F	PAf LFO2 PITCH DEPTH	[Pro]	0 - 600 [cent]
2b pp 09	00 00 01	00 - 7F	PAf LFO2 TVF DEPTH	[Pro]	0 - 2400 [cent]
2b pp 0A	00 00 01	00 - 7F	PAf LFO2 TVA DEPTH	[Pro]	0 - 100.0 [%]
2b pp 10	00 00 01	28 - 58	CC1 PITCH CONTROL	[Pro]	-24 - +24 [semitones]
2b pp 11	00 00 01	00 - 7F	CC1 TVF CUTOFF CONTROL	[Pro]	-9600 - +9600 [cent]
2b pp 12	00 00 01	00 - 7F	CC1 AMPLITUDE CONTROL	[Pro]	-100.0 - +100.0 [%]
2b pp 13	00 00 01	00 - 7F	CC1 LFO1 RATE CONTROL	[Pro]	-10.0 - +10.0 [Hz]
2b pp 14	00 00 01	00 - 7F	CC1 LFO1 PITCH DEPTH	[Pro]	0 - 600 [cent]
2b pp 15	00 00 01	00 - 7F	CC1 LFO1 TVF DEPTH	[Pro]	0 - 2400 [cent]
2b pp 16	00 00 01	00 - 7F	CC1 LFO1 TVA DEPTH	[Pro]	0 - 100.0 [%]
2b pp 17	00 00 01	00 - 7F	CC1 LFO2 RATE CONTROL	[Pro]	-10.0 - +10.0 [Hz]
2b pp 18	00 00 01	00 - 7F	CC1 LFO2 PITCH DEPTH	[Pro]	0 - 600 [cent]
2b pp 19	00 00 01	00 - 7F	CC1 LFO2 TVF DEPTH	[Pro]	0 - 2400 [cent]
2b pp 1A	00 00 01	00 - 7F	CC1 LFO2 TVA DEPTH	[Pro]	0 - 100.0 [%]

2b pp 20	00 00 01	28 - 58	CC2 PITCH CONTROL	[Pro] -24 - +24 [semitones]
2b pp 21	00 00 01	00 - 7F	CC2 TVF CUTOFF CONTROL	[Pro] -9600 - +9600 [cent]
2b pp 22	00 00 01	00 - 7F	CC2 AMPLITUDE CONTROL	[Pro] -100.0 - +100.0 [%]
2b pp 23	00 00 01	00 - 7F	CC2 LFO1 RATE CONTROL	[Pro] -10.0 - +10.0 [Hz]
2b pp 24	00 00 01	00 - 7F	CC2 LFO1 PITCH DEPTH	[Pro] 0 - 600 [cent]
2b pp 25	00 00 01	00 - 7F	CC2 LFO1 TVF DEPTH	[Pro] 0 - 2400 [cent]
2b pp 26	00 00 01	00 - 7F	CC2 LFO1 TVA DEPTH	[Pro] 0 - 100.0 [%]
2b pp 27	00 00 01	00 - 7F	CC2 LFO2 RATE CONTROL	[Pro] -10.0 - +10.0 [Hz]
2b pp 28	00 00 01	00 - 7F	CC2 LFO2 PITCH DEPTH	[Pro] 0 - 600 [cent]
2b pp 29	00 00 01	00 - 7F	CC2 LFO2 TVF DEPTH	[Pro] 0 - 2400 [cent]
2b pp 2A	00 00 01	00 - 7F	CC2 LFO2 TVA DEPTH	[Pro] 0 - 100.0 [%]
2b pp 30	00 00 01	00 - 03	TONE MAP NUMBER	[Pro] MAP 0 - 3
2b pp 31	00 00 01	01 - 03	TONE MAP-0 NUMBER	[Pro] SC-55 MAP - Native MAP
2b pp 33	00 00 01	00 - 01	EQ ON/OFF	[Pro] OFF / ON
2b pp 34	00 00 01	00 - 03	OUTPUT ASSIGN	[Pro] OUTPUT-1 - OUTPUT-2R
2b pp 35	00 00 01	00 - 01	PART EFX ASSIGN	[Pro] BYPASS - EFX

Section 4. Bulk Dump

Bulk Dump allows you to transmit a large amount of data at once, and is convenient for storing settings for the entire unit on a computer or sequencer. To make this unit perform a Bulk Dump transmission, send it a "Bulk Dump Request" message. Bulk Dump Request uses the Data Request 1 (RQ1) format, but unlike when transmitting individual parameters, the "Size" specified by the request message refers not to size of the data but rather specifies the contents of the data. For the data contents corresponding to each Size, refer to "Parameter Dump."
When this unit receives a Bulk Dump Request, it will transmit a Bulk Dump in the format given below.
This unit is also able to transmit a list of its internal sounds. This function can be used to display a list of sounds on a computer.

■ Parameter dump

○ Parameter dump request (receive only) [Pro]

This is a command that requests a set of parameter data, and uses "Data Request 1 (RQ1)" format. The Size specifies the requested data contents.

Address: 0C 00 00
Size: 00 00 00 : ALL request a dump of all parameters
00 00 01 : ALL 1 use this when not using USER TONE BANK or USER DRUM SET
00 00 02 : ALL 2 use this when USER TONE BANK, USER DRUM SET and DRUM SETUP settings have not been modified
00 00 10 : 16-part GS 1 use this when using only 16 Parts
00 00 11 : 16-part GS 2 use this when using only 16 Parts, and DRUM SETUP settings have not been modified
00 01 00 : USER TONE BANK (ALL) request a dump of all USER TONE BANK data
00 01 40 : USER TONE BANK #64 request a dump of USER TONE BANK #64 data (128 sounds)
00 01 41 : USER TONE BANK #65 request a dump of USER TONE BANK #65 data (128 sounds)
00 02 00 : USER DRUM SET (ALL) request a dump of all USER DRUM SET data
00 02 40 : USER DRUM SET #65 request a dump of USER DRUM SET #64 data
00 02 41 : USER DRUM SET #66 request a dump of USER DRUM SET #65 data
00 03 00 : USER EFX request a dump of USER EFX data
00 04 00 : USER PATCH request a dump of USER PATCH data

Example) Dump request for all parameters: F0 41 DEV 42 11 0C 00 00 00 00 00 74 F7

Normally, using ALL (00 00 00) provides the greatest predictability, but the amount of data is very large, and transmission requires approximately 25 seconds. In order to reduce transmission time and data volume, we suggest that you request a dump only of the necessary data. Panel button operations allow you to transmit dumps of ALL, ALL 1, 16-part GS 1, 16-part GS 2, USER TONE BANK (ALL), USER DRUM SET (ALL), USER EFX, USER PATCH.

○ Parameter dump [Pro]

When a Parameter Dump Request is received, or when panel operations initiate a dump transmission, the following data will be transmitted in "Data Set 1 (DT1)" format.

Address	Description	Number of packets	16-part USER TONE BANK USER DRUM SET --USER--														
			ALL	ALL1	ALL2	GS1	GS2	ALL	#64	#65	ALL	#65	#66	EFX	PATCH		
2A 00 00 - 2A 0F 7F	USER EFX #1-64	16	○													○	
2B 00 00 - 2B 5F 7F	USER PATCH #1-16	96	○														○
08 00 00 - 08 00 7F	SETUP	1	○	○	○	○	○										
28 00 00 - 28 0A 7F	USER TONE BANK #64	11	○							○	○						
28 10 00 - 28 1A 7F	USER TONE BANK #65	11	○							○		○					
29 00 00 - 29 0B 0F	USER DRUM SET #65	12	○									○	○				
29 10 00 - 29 1B 0F	USER DRUM SET #66	12	○									○		○			
48 1D 10 - 48 26 0F	PATCH EXTENSION A	9	○	○	○	○	○										
48 00 00 - 48 1D 0F	SYSTEM/PATCH A	30	○	○	○	○	○										
49 00 00 - 49 1F 7F	DRUM SETUP A	32	○	○		○											
58 1D 10 - 58 26 0F	PATCH EXTENSION B	9	○	○	○												
58 00 00 - 58 1D 0F	SYSTEM/PATCH B	30	○	○	○												
59 00 00 - 59 1F 7F	DRUM SETUP B	32	○	○													

This table lists the data contents that will be transmitted when panel buttons are used to request a dump, or when a Parameter Dump Request is received at MIDI IN A. When a Parameter Dump Request is received at MIDI IN B, A and B will be reversed for PATCH EXTENSION, SYSTEM/PATCH and DRUM SETUP.

* When data dumped by this unit is reloaded into this unit, be aware that the data may not be set correctly if the transmission order of the packets is changed, if the time interval between packets is changed, or if other messages are inserted between packets.

* The Parameter Dump data of this unit includes data for GS format compatible devices, and this data is compatible in both directions. However, depending on the settings of parameters which are newly extended on this unit, the musical result may differ.

* If this unit does not operate correctly with Bulk Dump data from another GS format compatible device, first initialize this unit (page 118) before retransmitting the data.

* When another GS format compatible device receives Parameter Dump data that was transmitted by this unit, it may display a message such as "Address Error", but this is because the parameter addresses newly extended on this unit were not recognized by the other device. Parameters which could be recognized by that device have been correctly set.

■ Dumping a list of internal sounds

● Instrument list dump

○ Instrument list dump request (request only) [Pro]

This command requests a bulk dump of a list of the preset sounds (Instruments) in internal memory, and uses "Data Request 1 (RQ1)" format. The Size specifies the contents of the requested data.

Address: 0C 00 01
 Size: 00 00 00 : ALL
 00 00 01 : SC-55 MAP
 00 00 02 : SC-88 MAP
 00 00 03 : Native MAP
 00 mm bb mm = MAP# 01 - 03 (01 = SC-55 MAP, 02 = SC-88 MAP,
 03 = Native MAP)
 bb = BANK# 00 - 7F

○ Instrument list dump (transmit only) [Pro]

When Instrument List Dump Request is received, the sound names of the specified map will be transmitted continuously in the format given below, where 16 bytes are used for each sound name. The Address of the transmitted data is 0C 00 01 for all packets. User bank sound names are not transmitted.

DUMP FORMAT:

0	1	2	3	4	5	6	7	8	9	A	B	C	D	E	F
CC0	MAP	PC	00	TONE NAME(ASCII 12 Characters)											

CC0 : Variation number
 MAP : MAP number 01 = SC-55 MAP, 02 = SC-88 MAP, 03 = Native MAP
 PC : Program number

● Drum set list dump

○ Drum set list dump request (receive only) [Pro]

This command requests a bulk dump transmission of a list of Preset Drum Sets in internal memory, and uses "Data Request 1 (RQ1)" format. The Size specifies the desired data contents.

Address: 0C 00 02
 Size: 00 00 00 : ALL
 00 00 01 : SC-55 MAP
 00 00 02 : SC-88 MAP
 00 00 03 : Native MAP

○ Drum set list dump (transmit only) [Pro]

When a Drum Set List Dump Request is received, the Drum Set names of the specified MAP will be transmitted successively in the format given below, where 16 bytes are used for each sound. The Address of the transmitted data will be 0C 00 02 for each packet.

DUMP FORMAT:

0	1	2	3	4	5	6	7	8	9	A	B	C	D	E	F
00	MAP	PC	00	DRUM TONE NAME(ASCII 12 Characters)											

MAP : MAP number 01 = SC-55 MAP, 02 = SC-88 MAP, 03 = Native MAP
 PC : Program number

● Drum instrument list dump

○ Drum instrument list dump request (receive only) [Pro]

This command requests a bulk dump transmission of the Instrument list of an internal Preset Drum Sets, and uses "Data Request 1 (RQ1)" format. The Size specifies the desired data contents.

Address: 0C 00 03
 Size: 00 mm pp mm = MAP# 01 - 03 (01 = SC-55 MAP, 02 = SC-88 MAP,
 03 = Native MAP)
 pp = Drum set# 00 - 7F (same as PC#)

○ Drum instrument list dump (transmit only) [Pro]

When a Drum Instrument List Dump Request is received, the Drum Instrument names of the specified Drum Set will be transmitted in the following format where 16 bytes are used for each Drum Instrument name. The address of the transmitted data will be 0C 00 03 for each packet.

DUMP FORMAT:

0	1	2	3	4	5	6	7	8	9	A	B	C	D	E	F
00	MAP	PC	KEY	DRUM TONE NAME(ASCII 12 Characters)											

MAP : MAP number 01 = SC-55 MAP, 02 = SC-88 MAP, 03 = Native MAP
 PC : Program number
 KEY : Note number

● Insertion effect list dump

○ Insertion effect list dump request (receive only) [Pro]

This command requests a bulk dump transmission of the Insertion effect list of an internal memory, and uses "Data Request 1 (RQ1)" format. The Size specifies the desired data contents.

Address: 0C 00 04
 Size: 00 00 00 : ALL

○ Insertion effect list dump (transmit only) [Pro]

When a Insertion Effect List Dump Request is received, the specified Insertion Effect names will be transmitted in the following format where 20 bytes are used for each Effect name. The address of the transmitted data will be 0C 00 04 for each packet.

DUMP FORMAT :

0	1	2	3	4	5	6	7	8	9	A	B	C	D	E	F	10	11	12	13
MSB	LSB	00	00	EFFECT NAME(ASCII 16 Characters)															

MSB : Category
 LSB : Type

● Preset patch list dump

○ Preset patch list dump request (receive only) [Pro]

This command requests a bulk dump transmission of the Preset patch list of an internal memory, and uses "Data Request 1 (RQ1)" format. The Size specifies the desired data contents.

Address: 0C 00 05
 Size: 00 00 00 : ALL

○ Preset patch list dump (transmit only) [Pro]

When a Preset Patch List Dump Request is received, the specified Preset patch names will be transmitted in the following format where 20 bytes are used for each Patch name. The address of the transmitted data will be 0C 00 05 for each packet.

DUMP FORMAT :

0	1	2	3	4	5	6	7	8	9	A	B	C	D	E	F	10	11	12	13
00	00	PC	00	PATCH NAME(ASCII 16 Characters)															

PC : Program number

Section 5. Supplementary material

● Decimal and Hexadecimal table

(An 'H' is appended to the end of numbers in hexadecimal notation.)

In MIDI documentation, data values and addresses/sizes of exclusive messages etc. are expressed as hexadecimal values for each 7 bits.

The following table shows how these correspond to decimal numbers.

Dec.	Hex.	Dec.	Hex.	Dec.	Hex.	Dec.	Hex.
0	00H	32	20H	64	40H	96	60H
1	01H	33	21H	65	41H	97	61H
2	02H	34	22H	66	42H	98	62H
3	03H	35	23H	67	43H	99	63H
4	04H	36	24H	68	44H	100	64H
5	05H	37	25H	69	45H	101	65H
6	06H	38	26H	70	46H	102	66H
7	07H	39	27H	71	47H	103	67H
8	08H	40	28H	72	48H	104	68H
9	09H	41	29H	73	49H	105	69H
10	0AH	42	2AH	74	4AH	106	6AH
11	0BH	43	2BH	75	4BH	107	6BH
12	0CH	44	2CH	76	4CH	108	6CH
13	0DH	45	2DH	77	4DH	109	6DH
14	0EH	46	2EH	78	4EH	110	6EH
15	0FH	47	2FH	79	4FH	111	6FH
16	10H	48	30H	80	50H	112	70H
17	11H	49	31H	81	51H	113	71H
18	12H	50	32H	82	52H	114	72H
19	13H	51	33H	83	53H	115	73H
20	14H	52	34H	84	54H	116	74H
21	15H	53	35H	85	55H	117	75H
22	16H	54	36H	86	56H	118	76H
23	17H	55	37H	87	57H	119	77H
24	18H	56	38H	88	58H	120	78H
25	19H	57	39H	89	59H	121	79H
26	1AH	58	3AH	90	5AH	122	7AH
27	1BH	59	3BH	91	5BH	123	7BH
28	1CH	60	3CH	92	5CH	124	7CH
29	1DH	61	3DH	93	5DH	125	7DH
30	1EH	62	3EH	94	5EH	126	7EH
31	1FH	63	3FH	95	5FH	127	7FH

* Decimal values such as MIDI channel, bank select, and program change are listed as one greater than the values given in the above table.

* A 7-bit byte can express data in the range of 128 steps. For data where greater precision is required, we must use two or more bytes. For example, two hexadecimal numbers aa bbH expressing two 7-bit bytes would indicate a value of aa x 128+bb.

* In the case of values which have a ± sign, 00H = -64, 40H = ±0, and 7FH = +63, so that the decimal expression would be 64 less than the value given in the above chart. In the case of two types, 00 00H = -8192, 40 00H = ±0, and 7F 7FH = +8191. For example if aa bbH were expressed as decimal, this would be aa bbH - 40 00H = aa x 128+bb - 64 x 128.

* Data marked "Use nibbled data" is expressed in hexadecimal in 4-bit units. A value expressed as a 2-byte nibble 0a 0bH has the value of a x 16+b.

<Example 1> What is the decimal expression of 5AH ?
From the preceding table, 5AH = 90

<Example 2> What is the decimal expression of the value 12 34H given as hexadecimal for each 7 bits?
From the preceding table, since 12H = 18 and 34H = 52
18 x 128+52 = 2356

<Example 3> What is the decimal expression of the nibbled value 0A 03 09 0D ?
From the preceding table, since 0AH = 10, 03H = 3, 09H = 9, 0DH = 13
((10 x 16+3) x 16+9) x 16+13 = 41885

<Example 4> What is the nibbled expression of the decimal value 1258?

```

16) 1258
   78 ... 10
  16)  4 ... 14
    0 ... 4

```

Since from the preceding table, 0 = 00H, 4 = 04H, 14 = 0EH, 10 = 0AH, the answer is 00 04 0E 0AH.

● Examples of actual MIDI messages

<Example 1> 92 3E 5F

9n is the Note-on status, and n is the MIDI channel number. Since 2H = 2, 3EH = 62, and 5FH = 95, this is a Note-on message with MIDI CH = 3, note number 62 (note name is D4), and velocity 95.

<Example 2> CE 49

CnH is the Program Change status, and n is the MIDI channel number. Since EH = 14 and 49H = 73, this is a Program Change message with MIDI CH = 15, program number 74 (Flute in GS).

<Example 3> EA 00 28

EnH is the Pitch Bend Change status, and n is the MIDI channel number. The 2nd byte (00H = 0) is the LSB and the 3rd byte (28H = 40) is the MSB, but Pitch Bend Value is a signed number in which 40 00H (= 64 x 12+80 = 8192) is 0, so this Pitch Bend Value is

28 00H - 40 00H = 40 x 12+80 - (64 x 12+80) = 5120 - 8192 = -3072

If the Pitch Bend Sensitivity is set to 2 semitones, -8192 (00 00H) will cause the pitch to change -200 cents, so in this case -200 x (-3072) ÷ (-8192) = -75 cents of Pitch Bend is being applied to MIDI channel 11.

<Example 4> B3 64 00 65 00 06 0C 26 00 64 7F 65 7F

BnH is the Control Change status, and n is the MIDI channel number. For Control Changes, the 2nd byte is the control number, and the 3rd byte is the value. In a case in which two or more messages consecutive messages have the same status, MIDI has a provision called "running status" which allows the status byte of the second and following messages to be omitted. Thus, the above messages have the following meaning.

B3	64 00	MIDI ch.4, lower byte of RPN parameter number	: 00H
(B3)	65 00	(MIDI ch.4) upper byte of RPN parameter number	: 00H
(B3)	06 0C	(MIDI ch.4) upper byte of parameter value	: 0CH
(B3)	26 00	(MIDI ch.4) lower byte of parameter value	: 00H
(B3)	64 7F	(MIDI ch.4) lower byte of RPN parameter number	: 7FH
(B3)	65 7F	(MIDI ch.4) upper byte of RPN parameter number	: 7FH

In other words, the above messages specify a value of 0C 00H for RPN parameter number 00 00H on MIDI channel 4, and then set the RPN parameter number to 7F 7FH.

RPN parameter number 00 00H is Pitch Bend Sensitivity, and the MSB of the value indicates semitone units, so a value of 0CH = 12 sets the maximum pitch bend range to ±12 semitones (1 octave). (On GS sound sources the LSB of Pitch Bend Sensitivity is ignored, but the LSB should be transmitted anyway (with a value of 0) so that operation will be correct on any device.)

Once the parameter number has been specified for RPN or NRPN, all Data Entry messages transmitted on that same channel will be valid, so after the desired value has been transmitted, it is a good idea to set the parameter number to 7F 7FH to prevent accidents. This is the reason for the (B3) 64 7F (B3) 65 7F at the end.

It is not desirable for performance data (such as Standard MIDI File data) to contain many events with running status as given in <Example 4>. This is because if playback is halted during the song and then rewound or fast-forwarded, the sequencer may not be able to transmit the correct status, and the sound source will then misinterpret the data. Take care to give each event its own status.

It is also necessary that the RPN or NRPN parameter number setting and the value setting be done in the proper order. On some sequencers, events occurring in the same (or consecutive) clock may be transmitted in an order different than the order in which they were received. For this reason it is a good idea to slightly skew the time of each event (about 1 tick for TPQN = 96, and about 5 ticks for TPQN = 480).

* TPQN: Ticks Per Quarter Note

● Example of an Exclusive message and calculating a Checksum

Roland Exclusive messages (RQ1, DT1) are transmitted with a checksum at the end (before F7) to make sure that the message was correctly received. The value of the checksum is determined by the address and data (or size) of the transmitted exclusive message.

◇ **How to calculate the checksum (hexadecimal numbers are indicated by 'H')**
 The checksum is a value derived by adding the address, size and checksum itself and inverting the lower 7 bits.
 Here's an example of how the checksum is calculated. We will assume that in the exclusive message we are transmitting, the address is aa bb cH and the data or size is dd ee ffH.

aa+bb+cc+dd+ee+ff = sum
 sum ÷ 128 = quotient ... remainder
 128 - remainder = checksum

<Example 1> Setting REVERB MACRO to ROOM 3
 According to the "Parameter Address Map," the REVERB MACRO Address is 40 01 30H, and ROOM 3 is a value of 02H. Thus,

F0 41 10 42 12 40 01 30 02 ?? FZ
 (1) (2) (3) (4) (5) address data checksum (6)

(1) Exclusive Status, (2) ID (Roland), (3) Device ID (17),
 (4) Model ID (GS), (5) Command ID (DT1), (6) End of Exclusive

Next we calculate the checksum.

40H+01H+30H+02H = 64+1+48+2 = 115 (sum)
 115 (sum) ÷ 128 = 0 (quotient) ... 115 (remainder)
 checksum = 128 - 115 (remainder) = 13 = 0DH

This means that F0 41 10 42 12 40 01 30 02 0D F7 is the message we transmit.

<Example 2> Requesting transmission of the LEVEL for DRUM MAP 1 NOTE NUMBER 75 (D#5; Claves)
 NOTE NUMBER 75 (D#5) is 4BH in hexadecimal.
 According to the "Parameter Address Map," LEVEL of NOTE NUMBER 75 (D#5; Claves) in DRUM MAP 1 has an Address of 41 02 4BH and a Size of 00 00 01H. Thus,

F0 41 10 42 11 41 02 4B 00 00 01 ?? FZ
 (1) (2) (3) (4) (5) address size checksum (6)

(1) Exclusive Status, (2) ID (Roland), (3) Device ID (17),
 (4) Model ID (GS), (5) Command ID (RQ1), (6) End of Exclusive

Next we calculate the checksum.

41H+02H+4BH+00H+00H+01H = 65+2+75+0+0+1 = 143 (sum)
 143 (sum) ÷ 128 = 1 (quotient) ... 15 (remainder)
 checksum = 128 - 15 (remainder) = 113 = 71H

This means that F0 41 10 42 11 41 02 4B 00 00 01 71 F7 is the message we transmit.

● About tuning

In MIDI, individual Parts are tuned by sending RPN #1 (Master Fine Tuning) to the appropriate MIDI channel.

In MIDI, an entire device is tuned by either sending RPN #1 to all MIDI channels being used, or by sending a System Exclusive MASTER TUNE (address 40 00 00H).

RPN #1 allows tuning to be specified in steps of approximately 0.012 cents (to be precise, 100/8192 cent), and System Exclusive MASTER TUNE allows tuning in steps of 0.1 cent. One cent is 1/100th of a semitone.

The values of RPN #1 (Master Fine Tuning) and System Exclusive MASTER TUNE are added together to determine the actual pitch sounded by each Part.

Frequently used tuning values are given in the following table for your reference. Values are in hexadecimal (decimal in parentheses).

Hz at A4	cent	RPN #1	Sys.Ex. 40 00 00
445.0	+19.56	4C 43 (+1603)	00 04 0C 04 (+196)
444.0	+15.67	4A 03 (+1283)	00 04 09 0D (+157)
443.0	+11.76	47 44 (+ 964)	00 04 07 06 (+118)
442.0	+ 7.85	45 03 (+ 643)	00 04 04 0F (+ 79)
441.0	+ 3.93	42 42 (+ 322)	00 04 02 07 (+ 39)
440.0	0	40 00 (0)	00 04 00 00 (0)
439.0	- 3.94	3D 3D (- 323)	00 03 0D 09 (- 39)
438.0	- 7.89	3A 7A (- 646)	00 03 0B 01 (- 79)

<Example> Set the tuning of MIDI channel 3 to A4 = 442.0 Hz
 Send RPN#1 to MIDI channel 3. From the above table, the value is 45 03H.

B2 64 00 MIDI ch.3, lower byte of RPN parameter number : 00H
 (B2) 65 01 (MIDI ch.3) upper byte of RPN parameter number : 01H
 (B2) 06 45 (MIDI ch.3) upper byte of parameter value : 45H
 (B2) 26 03 (MIDI ch.3) lower byte of parameter value : 03H
 (B2) 64 7F (MIDI ch.3) lower byte of RPN parameter number : 7FH
 (B2) 65 7F (MIDI ch.3) upper byte of RPN parameter number : 7FH

● The Scale Tune Feature (address: 40 1x 40)

The scale Tune feature allows you to finely adjust the individual pitch of the notes from C through B. Though the settings are made while working with one octave, the fine adjustments will affect all octaves. By making the appropriate Scale Tune settings, you can obtain a complete variety of tuning methods other than equal temperament. As examples, three possible types of scale setting are explained below.

○ Equal Temperament

This method of tuning divides the octave into 12 equal parts. It is currently the most widely used form of tuning, especially in occidental music. On this unit, the default settings for the Scale Tune feature produce equal temperament.

○ Just Temperament (Keytone C)

The three main chords resound much more beautifully than with equal temperament, but this benefit can only be obtained in one key. If transposed, the chords tend to become ambiguous. The example given involves settings for a key in which C is the keynote.

○ Arabian Scale

By altering the setting for Scale Tune, you can obtain a variety of other tunings suited for ethnic music. For example, the settings introduced below will set the unit to use the Arabian Scale.

Example Settings

Note name	Equal Temperament	Just Temperament (Keytone C)	Arabian Scale
C	0	0	-6
C#	0	-8	+45
D	0	+4	-2
D#	0	+16	-12
E	0	-14	-51
F	0	-2	-8
F#	0	-10	+43
G	0	+2	-4
G#	0	+14	+47
A	0	-16	0
A#	0	+14	-10
B	0	-12	-49

The values in the table are given in cents. Refer to the explanation of Scale Tuning on page 198 to convert these values to hexadecimal, and transmit them as exclusive data.

For example, to set the tune (C-B) of the Part1 Arabian Scale, send the data as follows:

F0 41 10 42 12 40 11 40 3A 6D 3E 34 0D 38 6B 3C 6F 40 36 0F 76 F7

MIDI Implementation Chart

Function...	Transmitted	Recognized	Remarks
Basic Channel Default Changed	X X	1-16 1-16	Memorized
Mode Default Message Altered	X X *****	Mode 3 Mode 3, 4(M=1)	*2
Note Number : True Voice	X *****	0-127 0-127	
Velocity Note ON Note OFF	X X	○ X	
After Touch Key's Ch's	X X	○ *1 ○ *1	
Pitch Bend	X	○ *1	
Control Change 0, 32 1 5 6, 38 7 10 11 64 65 66 67 84 91 93 94 98, 99 100, 101	X X X X X X X X X X X X X X X X X	○ *1 ○ *1 ○ *1 ○ *1 ○ *1 ○ *1 ○ *1 ○ *1 ○ *1 ○ *1 ○ *1 ○ *1 ○ *1 ○ *1 ○ *1 ○ *1 ○ *1 ○ *1 ○ *1 X *1 ○ *1	Bank select Modulation Portamento time Data entr Volume Pan Expression Hold 1 Portamento Sostenuto Soft Portamento control Effect 1 (Reverb Send Level) Effect 3 (Chorus Send Level) Effect 4 (Delay Send Level) NRPN LSB,MSB RPN LSB,MSB
Program Change : True #	X *****	○ *1 0-127	Program Number: 1-128
System Exclusive	○	○	
System : Song Pos Common : Song Sel : Tune	X X X	X X X	
System : Clock Real Time : Commands	X X	X X	
Aux Messages : All Sounds OFF : Reset All Controllers : Local ON/OFF : All Notes OFF : Active Sensing : Reset	X X X X ○ X	○ (120,126,127) ○ X ○ (123-125) ○ X	
Notes	*1 ○ X is selectable. *2 Recognize as M=-1 even if M ≠ 1		

Mode 1 : OMNI ON, POLY
 Mode 2 : OMNI ON, MONO
 Mode 3 : OMNI OFF, POLY
 Mode 4 : OMNI OFF, MONO

○ : Yes
 X : No

INDEX

[A—K]	
Active Sensing.....	133
Aftertouch.....	33, 132
All Note Off.....	133
All Sound Off.....	133
Apple Macintosh.....	120
Assign Group.....	44
Assign Lock.....	38
Attack Time.....	33
Audio Input.....	15
Back Up Switch.....	37
Bank Select.....	126
Bar Indicator.....	9
Battery.....	3
Bend	
Range.....	30
Cutoff.....	30
Amp.....	30
LFO Rate.....	30
LFO Pitch.....	30
LFO TVF.....	30
LFO TVA.....	30
Bulk Dump.....	107
Bulk Dump Data.....	107
CAf	
Range.....	30
Cutoff.....	30
Amp.....	30
LFO Rate.....	30
LFO Pitch.....	30
LFO TVF.....	30
LFO TVA.....	30
Capital.....	20
CC1	
Range.....	30
Cutoff.....	30
Amp.....	30
LFO Rate.....	30
LFO Pitch.....	30
LFO TVF.....	30
LFO TVA.....	30
CC1 Controller Number.....	29
Channel.....	22, 41, 130
Channel Aftertouch.....	30
Channel Pressure.....	30
Chorus	
All Chorus.....	50
Part Chorus.....	13, 50
Chorus Delay.....	53
Chorus Depth.....	53
Chorus Feedback.....	53
Chorus Level.....	53
Chorus Pre-LPF.....	53
Chorus Rate.....	53
Chorus Send Level.....	132
Chorus Send Level To Delay.....	53
Chorus Send Level To Reverb.....	53
Chorus Type.....	53
CM-64.....	114
Computer Cable.....	120
Computer Switch.....	120
Contrast (Display).....	38
Control Change.....	131
Cutoff Frequency.....	33
Data Entry.....	132
Decay Time.....	33
Delay	
All Delay.....	50
Part Delay.....	13, 50
Delay Feedback.....	54
Delay Level.....	54
Delay Level Center.....	54
Delay Level Left.....	54
Delay Level Right.....	54
Delay Pre-LPF.....	54
Delay Send Level.....	132
Delay Send Level To Reverb.....	54
Delay Time Center.....	54
Delay Time Ratio Left.....	54
Delay Time Ratio Right.....	54
Delay Type.....	54
Device ID.....	134
Display.....	37
Double Module Mode.....	116
Drum Edit.....	42
Drum Part.....	27
Drum Set.....	18, 128
Dump.....	107
Dump Data.....	107
Effect	
Insertion Effect.....	56
System Effect.....	48
EFX Control Depth.....	92
EFX Control Source.....	92
EFX Param.....	56
EFX Type.....	56
EFX Value.....	56
EQ Lock.....	140
Error Message.....	148
Exclusive Message.....	133
Expression.....	131
Factory Preset.....	118
Fine Tune.....	28
Frame Draw.....	110
GM Initialize.....	118
GM System.....	2, 118
GM System On.....	140
GS Initialize.....	118
GS Format.....	2
GS Reset.....	140
Headphone.....	15
High Frequency.....	49
High Gain.....	49
Hold1.....	132
IBM PC/AT.....	120
In B Select.....	135
Individual Data.....	108
Initialize.....	118
Input Modes.....	137
Instrument.....	10, 18
Keyboard Range H.....	28
Keyboard Range L.....	28
Key Shift	
Master Key Shift.....	35
Part Key Shift.....	12, 25
[L—P]	
LCD Contrast.....	38

Legato-enable sound.....	24	Resonance	33
Level		Reverb	
Master Level	35	All Reverb	50
Part Level.....	11, 25	Part Reverb.....	13, 50
Low Frequency.....	49	Reverb Character	52
Low Gain	49	Reverb Delay Feedback.....	52
Master Tune	14	Reverb Level	52
Maximum Polyphony	24	Reverb Pre Delay Time	52
MIDI.....	130	Reverb Pre-LPF	52
MIDI Channel	22, 41, 130	Reverb Send Level.....	132
MIDI Connector	135	Reverb Time	52
MIDI Implementation	188	Reverb Type	52
MIDI Implementation chart	209	RPN.....	132, 142
MIDI IN B.....	135	Rx.Bank sel	141
Modulation		Rx.GM On	140
Range	30	Rx.GS Reset	140
Cutoff	30	Rx.NRPN.....	141
Amp	30	Rx Sys Mode.....	137
LFO Rate	30	SC-88 compatible mode.....	112
LFO Pitch.....	30	SC-55 MAP	
LFO TVF	30	All SC-55MAP.....	34
LFO TVA.....	30	Part SC-55MAP	25
Mono/Poly Mode	27	SC-88 MAP	
Multi-Timbral Sound Module	18	All SC-88MAP.....	34
Mute		Part SC-88MAP	25
All Mute.....	34	Scale Tuning	29
Part Mute	25	SFX	160, 169, 175
Mute Lock.....	140	Single Module Mode.....	116
Normal Part	27	Soft	132
Note Message	131	Sostenuto	132
Note Number	131	System Effect	48
NRPN	132, 142	System Exclusive Message.....	133
Output Assign.....	29	System Mode Set receive switch	137
OUT/THRU Select.....	136	System Output Mode.....	38
Pan		THRU	136
Master Pan	35	THRU Function.....	123
Part Pan.....	11, 25	Tuning	14
Part.....	18	User Drum Edit.....	102
Part Copy	106	User Effect.....	99
Part EQ.....	27	User Instrument Edit.....	96
Part Exchange.....	106	User Patch.....	101
Part Initialize	106	User Patch Name	100
Part Mode	27	Variation	20
Part Monitor	27	Velocity Sens Depth	28
Part Parameter	25, 31	Velocity Sens Offset	28
Patch		Vibrato Delay.....	32
Preset Patch	39	Vibrato Depth	32
User Patch.....	101	Vibrato Rate	32
Patch Load Initialize Switch.....	38	Voice	24
Peak Hold.....	37	Volume	11, 131
Pitch Bend Change	131		
Pitch Coarse.....	43		
Polyphonic Key Pressure	132		
Portamento.....	132		
Portamento Control	132		
Portamento Time.....	132		
Power	9		
Preview Note Name	37		
Preview Velocity	37		
Program Change	126, 131		
[R—V]			
Release Time	33		
Reset All controllers	133		

For Nordic Countries

Apparatus containing Lithium batteries

ADVARSEL!

Lithiumbatteri - Eksplosionsfare ved fejlagtig håndtering.
Udskiftning må kun ske med batteri af samme fabrikat og type.
Levér det brugte batteri tilbage til leverandøren.

VARNING!

Explosionsfara vid felaktigt batteribyte.
Använd samma batterityp eller en ekvivalent typ som rekommenderas av apparattillverkaren.
Kassera använt batteri enligt fabrikantens instruktion.

ADVARSEL!

Lithiumbatteri - Eksplosjonsfare.
Ved utskifting benyttes kun batteri som anbefalt av apparatfabrikanten.
Brukt batteri returneres apparatleverandøren.

VAROITUS!

Paristo voi räjähtää, jos se on virheellisesti asennettu.
Vaihda paristo ainoastaan laitevalmistajan suosittelemaan tyyppiin. Hävitä käytetty paristo valmistajan ohjeiden mukaisesti.



For Europe

This product complies with the requirements of European Directive 89/336/EEC.

For the USA

FEDERAL COMMUNICATIONS COMMISSION RADIO FREQUENCY INTERFERENCE STATEMENT

This equipment has been tested and found to comply with the limits for a Class B digital device, pursuant to Part 15 of the FCC Rules. These limits are designed to provide reasonable protection against harmful interference in a residential installation. This equipment generates, uses, and can radiate radio frequency energy and, if not installed and used in accordance with the instructions, may cause harmful interference to radio communications. However, there is no guarantee that interference will not occur in a particular installation. If this equipment does cause harmful interference to radio or television reception, which can be determined by turning the equipment off and on, the user is encouraged to try to correct the interference by one or more of the following measures:

- Reorient or relocate the receiving antenna.
- Increase the separation between the equipment and receiver.
- Connect the equipment into an outlet on a circuit different from that to which the receiver is connected.
- Consult the dealer or an experienced radio/TV technician for help.

Unauthorized changes or modification to this system can void the users authority to operate this equipment.
This equipment requires shielded interface cables in order to meet FCC class B Limit.

For Canada

CLASS B

NOTICE

This digital apparatus does not exceed the Class B limits for radio noise emissions set out in the Radio Interference Regulations of the Canadian Department of Communications.

CLASSE B

AVIS

Cet appareil numérique ne dépasse pas les limites de la classe B au niveau des émissions de bruits radioélectriques fixés dans le Règlement des signaux parasites par le ministère canadien des Communications.

Specifications

Model : Sound Canvas SC-88 Pro
(General MIDI System  /GS format )

● Number of parts

32

● Maximum Polyphony

64 (voices)

● Internal Memory

Sound map : 3 (SC-55, SC-88, Native map)
Preset sounds : 1117
Drum sound set : 42 (include 3 SFX Set)
User sounds : 256
User drum sound set : 2
User Effect : 64

Preset Patch : 128(with Effect)
User Patch : 16

● Effects

Reverb (8type)
Chorus (8type)
Delay (10type)
2 band equalizer
Insertion Effect (64type)

● Display

70.6 x 24.5mm (backlit LCD)

● Connectors

MIDI connectors
(IN A, IN B Front/Rear, OUT/THRU)
Audio Input jack x 2 (L,R)
Input Volume Knob
Audio Output jack x 4 (OUTPUT-1L,1R,2L,2R)
Headphones jack
Computer terminal
Computer Switch

● Power Supply

AC117V, AC230V or 240V

● Power Consumption

16W (AC117V),16W (230V/240V)

● Dimensions

218 (W) x 250 (D) x 72 (H) mm
8-5/8 (W) x 9-7/8 (D) x 2-7/8 (H) inches

● Weight

2.6 kg
5 lbs 12 oz

● Accessories

Owner's manual

● Options

Computer cable
RSC-15AT (For IBM PC/AT series)
RSC-15APL (For Apple Macintosh series)

* *In the interest of product improvement, the specifications and/or appearance of this unit are subject to change without prior notice.*